

Fleur de Bois

8 COLOURS

4 SIZES

3 SURFACES

A collection inspired by a mix of wood types – hickory and Italian walnut – skilfully blended in order to achieve a balance and highlight their best aesthetic expressions; those produced by typical longitudinal grains with a regular and elegant pattern; more contrasted for the hickory, more harmonic for the Italian walnut.

Una collezione ispirata ad un mix
essenze di noce americano e di
noce nazionale sapientemente
miscelate tra loro, alla ricerca
dell'equilibrio per coglierne le migliori
espressioni estetiche; quelle date
dalle tipiche venature longitudinali
con andamento regolare ed
elegante; più contrastate per il noce
americano, più armoniche per il noce
nazionale.

Eine Kollektion, die sich an einem
gelungenen Mix aus amerikanischem
und europäischem Walnussbaum
inspiriert, wobei die schönsten
Ausdrucksformen zu einem
ausgewogenen Ganzen komponiert
wurden: Die typischen, regelmäßigen
und eleganten Längsäderungen sind
beim amerikanischen Nussbaum
markanter und in der europäischen
Variante harmonischer ausgeprägt.

Cette collection s'inspire d'un
mélange d'essences de noyer
d'Amérique et de noyer d'Italie,
savamment associées l'une à l'autre
en un équilibre qui exalte leurs plus
belles expressions esthétiques: celles
qui résultent d'un veinage longitudinal
typique, régulier et élégant, plus
contrasté sur le noyer d'Amérique,
plus harmonieux sur le noyer d'Italie.

Fleur de Bois

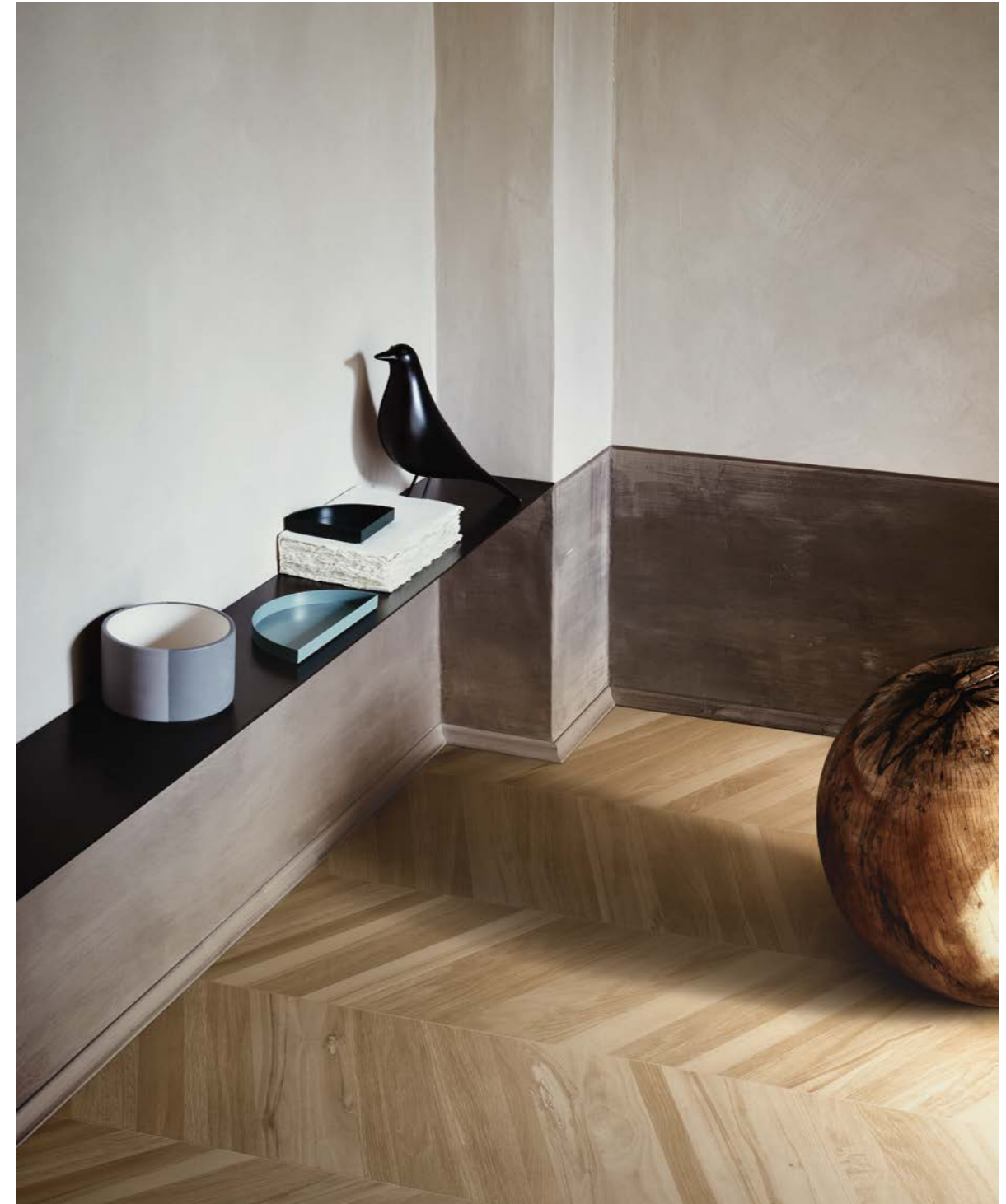

Villa sulla Riviera del Brenta
Villa on the Brenta Riviera

P. 5

Hotel metropolitano con vista
Metropolitan hotel with a view

P. 23

Informazioni Tecniche
Technical Information

P. 41

Grazie all'evoluzione delle tecnologie digitali la ceramica è in grado di sostituire materiali provenienti dalla natura. In tal senso è anche ecologica, perché evita disboscamenti e ferite nel paesaggio, concentrando in un sito industriale efficiente il consumo di energia. La collezione Fleur de Bois s'inserisce in questo ciclo tecnologico, guidato dalla ragione, col fine di realizzare con la ceramica quello che il legno non consente.

Ceramics Are Smart

Thanks to the evolution of digital technologies, ceramics are able to replace natural materials. In this sense they are also ecological, because they prevent deforestation and damaging the landscape, and concentrate energy consumption in an efficient industrial site.

The Fleur de Bois collection is part of this technological cycle, prompted by reason, with the aim of producing with ceramics that which wood does not permit.

Keramik Ist Intelligent

Dank der Weiterentwicklung der Digitaltechnologie ist die Keramik in der Lage, natürliche Materialien zu ersetzen. Damit ist sie auch umweltfreundlich, denn sie vermeidet das Abholzen und Verschandeln der Landschaft, und der Energieverbrauch wird in einer effizienten Industrieanlage konzentriert.

Die Kollektion Fleur de Bois entsteht aus diesem rationellen Technologiezyklus, der aus Keramik das zu produzieren erlaubt, was mit Holz nicht möglich wäre.

La Céramique : Un Matériau Intelligent

L'évolution des technologies numériques transforme la céramique en une matière à même de remplacer les ressources de la nature. Nous pouvons d'ailleurs la qualifier d'écologique, parce qu'elle n'implique ni déboisement ni dévalorisation du paysage, en concentrant la consommation d'énergie dans un site industriel énergétiquement efficace.

La collection Fleur de Bois s'inscrit dans ce courant technologique, guidé par la raison, dans le but de faire avec la céramique tout ce que le bois ne permet pas de faire.

Villa sulla Riviera del Brenta

Villa on the Brenta Riviera
Villa an der Riviera del Brenta
Villa au bord du Brenta



COLORI / COLOURS

AMBIENTI / AMBIENT

PAGINA / PAGE

Chevron Miel

Living Room

6

Beige

Bedroom

12

Blanc

Bathroom

16

Gris

Kitchen

20





Miel

Through the work of years, centuries and millennia, nature offers us wonderful but finite materials, to be used with caution and wisdom. With their intelligence human beings have transformed natural elements inventing ceramics, with which to rewrite over time the languages of architecture and life.

Über Jahre, Jahrhunderte und Jahrtausende hinweg kreiert die Natur wunderbare, aber nicht unendlich verfügbare Materialien, die wir umsichtig und klug verwenden müssen. Mit seiner Intelligenz hat der Mensch die Naturelemente verwandelt und die Keramik erfunden, mit der im Laufe der Zeit die Sprachen der Architektur und des Lebens neugeschrieben werden.

Après un travail incessant pouvant durer des années, des siècles, voire même des millénaires, la nature nous offre des matériaux merveilleux et finis, dont l'emploi exige discernement et sagesse. En utilisant son intelligence, l'homme a transformé les éléments naturels en inventant la céramique, avec laquelle réécrire au fil du temps les langages de l'architecture et de la vie.

Con il lavoro di anni, secoli e millenni la natura ci offre materiali meravigliosi, ma finiti, da usare con oculatezza e sapienza. Con la sua intelligenza l'essere umano ha trasformato gli elementi naturali inventando la ceramica, con cui riscrivere nel tempo i linguaggi dell'architettura e della vita.

60×119,5 - 24"×47½" Chevron Naturale Rettificato



Fleur de Bois
Residential Space





History and modernity, united in a new home, free, easy and responsible, where Fleur de Bois is everywhere and lives at length in entrances, kitchens, living rooms and bathrooms, i.e., in those environments where wood could become inevitably scratched or stained.

Geschichte und Gegenwart, vereint in einem Zuhause, das freier, einfacher, verantwortungsbewusster ist. Wo Fleur de Bois überall seine Langlebigkeit unter Beweis stellt: im Eingang, in der Küche, im Wohnzimmer und im Bad: eben überall dort, wo Holz verkratzt werden könnte oder nicht entfernbare Flecken entstehen könnten.

Le passé et le présent se côtoient dans une maison plus libre, facile et responsable, où Fleur de Bois est partout et vit longtemps dans les entrées, les cuisines, les salons et les salles de bains, bref dans ces pièces où le bois risquerait de se rayer ou de se tacher inexorablement.

Storia e attualità, unite in una casa più libera, facile, responsabile, dove Fleur de Bois è ovunque e a lungo vive in ingressi, cucine, soggiorni e bagni, ossia in quegli ambienti in cui il legno potrebbe graffiarsi o macchiarsi inesorabilmente.







Hotel metropolitano con vista

Metropolitan hotel with a view
Großstadthotel mit herrlichem Panorama
Hôtel citadin avec vue



COLORI / COLOURS

AMBIENTI / AMBIENT

PAGINA / PAGE

Chevron Chocolat

Hall

24

Naturel

Solarium & Pool

28

Brun

Restaurant

32

Chevron Glace

SPA

36

Gris

Bathroom

38

Fleur de Bois
Commercial Space

23

















Informazioni Tecniche

8

Colori
Colours
Farben
Couleurs



4

Formati
Sizes
Formate
Formats

60×119,5 24"×47½"	20×119,5 8"×47½"	*22,5×90 9"×36"	*15×90 6"×36"
----------------------	---------------------	--------------------	------------------

1

Spessori
Thickness
Stärke
Epaisseur

±9,5

3

Superfici
Surfaces
Oberflächen
Surfaces

Naturale Levigato Antislip

i

Effetto Legno
Wood Look
Holzoptik
Effet Bois

Rivestimento
Wall Tiles
Wandfliesen
Revêtement

Pavimento
Floor Tiles
Bodenfliesen
Sol

Gres fine porcellanato ad impasto colorato
Coloured-body fine porcelain stoneware
Feinsteinzeug aus farbiger Masse
Grès cérame fin à pâte colorée

Tecnologia digitale
Digital technology
Digital Technologie
Technologie numérique

*Attenzione: verificare in fase di ordine il codice e l'imballo (22,5×90 - 15×90)

*Note: In the ordering phase please check code and packaging (22,5×90 - 15×90)

*Bitteachten: Beim Bestellen bitte die Kodenummer und die Verpackung kontrollieren (22,5×90 - 15×90)

*Attention : Merci de vérifier emballage et la référence au moment de la commande (22,5×90 - 15×90)



Blanc



15×90 – 6"×36"

03698 | Fleur de Bois Blanc Nat/Ret



22,5×90 – 9"×36"

03699 | Fleur de Bois Blanc Nat/Ret



20×119,5 – 8"×47½"

03015 | Fleur de Bois Blanc Nat/Ret
03458 | Fleur de Bois Blanc Antislip/Ret



30×30 – 12"×12"

02046 | Fleur de Bois Blanc Linear Nat/Ret

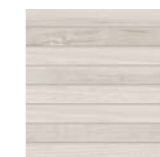

20×20 – 8"×8"

02052 | Fleur de Bois Blanc Tarsia Nat/Ret

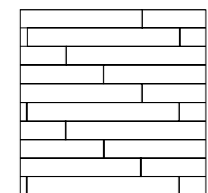

Posa Corretta
Correct Laying

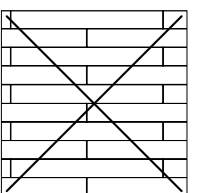

Posa Sconsigliata
Wrong Laying No 50%

Per un risultato di posa ottimale si consiglia di prelevare i listoni da 5 scatole contemporaneamente.

For best installation results, we suggest taking the floorboard tiles from 5 boxes at the same time.

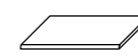
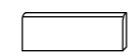



Gris



± 9,5

15x90 - 6"x36"

03821 | Fleur de Bois Gris Nat/Ret



± 9,5

22,5x90 - 9"x36"

03815 | Fleur de Bois Gris Nat/Ret



± 9,5

20x119,5 - 8"x47½"

03014 | Fleur de Bois Gris Nat/Ret
03457 | Fleur de Bois Gris Antislip/Ret



30x30 - 12"x12"

02045 | Fleur De Bois Gris Linear Nat/Ret



20x20 - 8"x8"

02051 | Fleur de Bois Gris Tarsia Nat/Ret

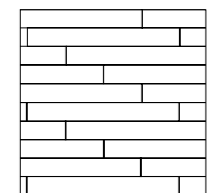

Posa Corretta
Correct Laying

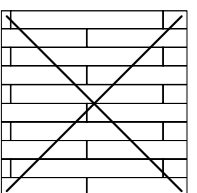

Posa Sconsigliata
Wrong Laying No 50%

Per un risultato di posa ottimale si consiglia di prelevare i listoni da 5 scatole contemporaneamente.

For best installation results, we suggest taking the floorboard tiles from 5 boxes at the same time.

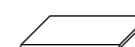
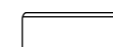



Naturel



15x90 – 6"x36"
03696 | Fleur de Bois Naturel Nat/Ret



22,5x90 – 9"x36"
03697 | Fleur de Bois Naturel Nat/Ret



20x119,5 – 8"x47½"
03013 | Fleur de Bois Naturel Nat/Ret
03459 | Fleur de Bois Naturel Antislip/Ret



30x30 – 12"x12"
02047 | Fleur de Bois Naturel Linear Nat/Ret



20x20 – 8"x8"
02053 | Fleur de Bois Naturel Tarsia Nat/Ret

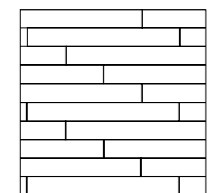

Posa Corretta
Correct Laying

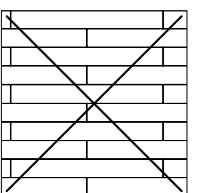

Posa Sconsigliata
Wrong Laying No 50%

Per un risultato di posa ottimale si consiglia di prelevare i listoni da 5 scatole contemporaneamente.

For best installation results, we suggest taking the floorboard tiles from 5 boxes at the same time.

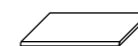
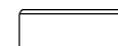

Beige



15x90 - 6"x36"

03822 | Fleur de Bois Beige Nat/Ret



22,5x90 - 9"x36"

03816 | Fleur de Bois Beige Nat/Ret

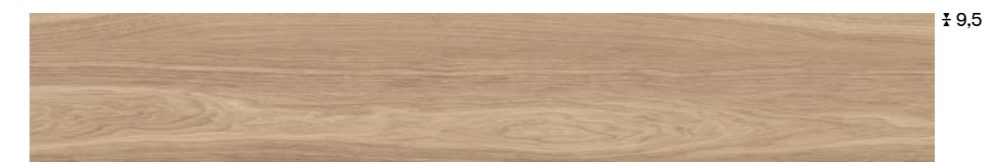

20x119,5 - 8"x47½"

03016 | Fleur de Bois Beige Nat/Ret
03461 | Fleur de Bois Beige Antislip/Ret

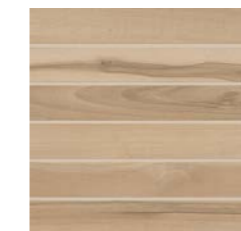

30x30 - 12"x12"

02048 | Fleur de Bois Beige Linear Nat/Ret

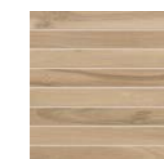

20x20 - 8"x8"

02054 | Fleur de Bois Beige Tarsia Nat/Ret

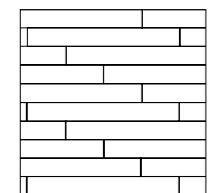

Posa Corretta
Correct Laying

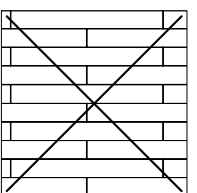

Posa Sconsigliata
Wrong Laying No 50%

Per un risultato di posa ottimale si consiglia di prelevare i listoni da 5 scatole contemporaneamente.

For best installation results, we suggest taking the floorboard tiles from 5 boxes at the same time.

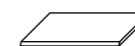

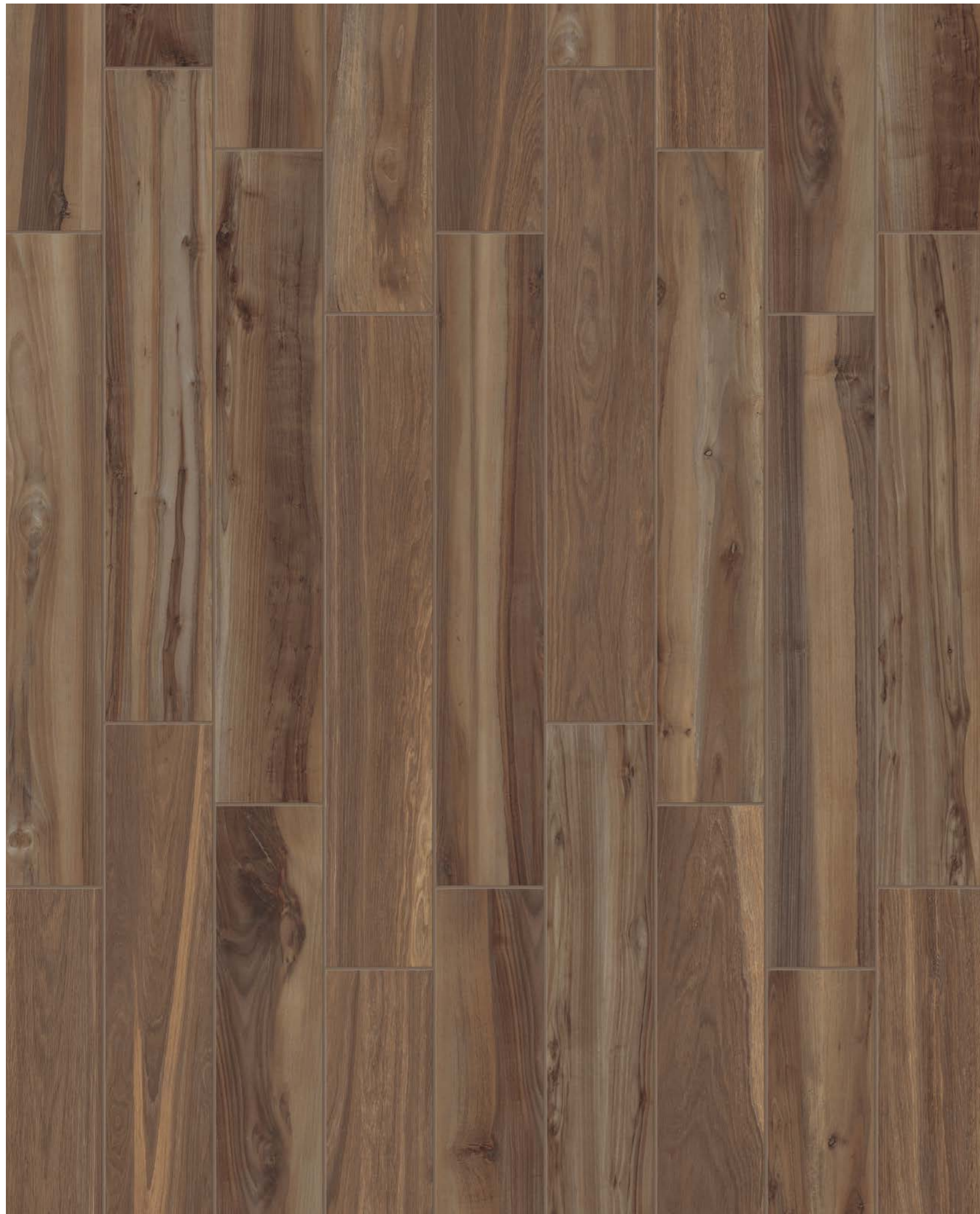

Brun

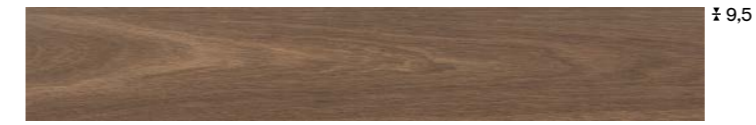

15x90 – 6"x36"

03823 | Fleur de Bois Brun Nat/Ret

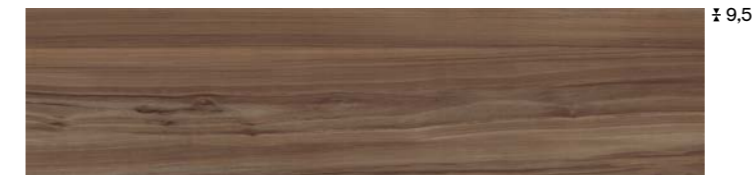

22,5x90 – 9"x36"

03817 | Fleur de Bois Brun Nat/Ret

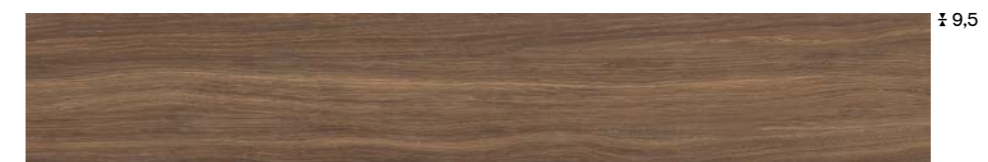

20x119,5 – 8"x47½"

03017 | Fleur de Bois Brun Nat/Ret
03462 | Fleur de Bois Brun Antislip/Ret



30x30 – 12"x12"

02049 | Fleur de Bois Brun Linear Nat/Ret

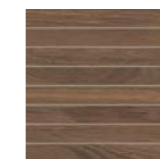

20x20 – 8"x8"

02055 | Fleur de Bois Brun Tarsia Nat/Ret

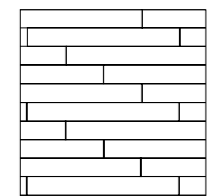

Posa Corretta
Correct Laying

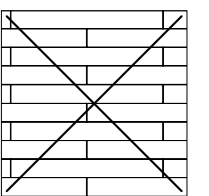

Posa Sconsigliata
Wrong Laying No 50%

Per un risultato di posa ottimale si consiglia di prelevare i listoni da 5 scatole contemporaneamente.

For best installation results, we suggest taking the floorboard tiles from 5 boxes at the same time.

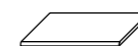
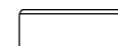



Chevron Glace



60×119,5 - 24"×47½"

03025 | Chevron Glace Nat/Ret*

03028 | Chevron Glace Lev/Ret*

Chevron Miel



60×119,5 - 24"×47½"

03024 | Chevron Miel Nat/Ret

03027 | Chevron Miel Lev/Ret

Chevron Chocolat

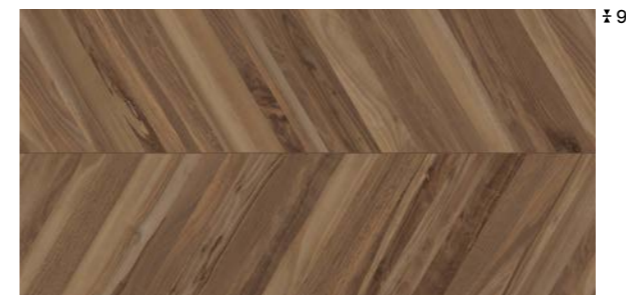

60×119,5 - 24"×47½"

03026 | Chevron Chocolat Nat/Ret*

03029 | Chevron Chocolat Lev/Ret*

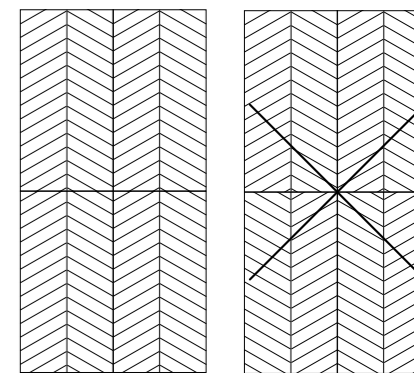

Posa corretta
Correct laying

Posa sconsigliata
Wrong laying

Riepilogo Gamma

Collection
Serie
Gamme

	Formati Sizes					Din 51130	Din 51097	Dcof	
		± 9,5	± 9,5	± 9,5	± 9,5				
Blanc	Nat/Ret	03015	03699	03698		V3	R9	A	>0.42
	Antislip/Ret	03458					R11	A+B+C	>0.42
Gris	Nat/Ret	03014	03815	03821		V3	R9	A	>0.42
	Antislip/Ret	03457					R11	A+B+C	>0.42
Naturel	Nat/Ret	03013	03697	03696		V3	R9	A	>0.42
	Antislip/Ret	03459					R11	A+B+C	>0.42
Beige	Nat/Ret	03016	03816	03822		V3	R9	A	>0.42
	Antislip/Ret	03461					R11	A+B+C	>0.42
Brun	Nat/Ret	03017	03817	03823		V3	R9	A	>0.42
	Antislip/Ret	03462					R11	A+B+C	>0.42
Glace	Nat/Ret				03025		R9	A	>0.42
	Lev/Ret				03028				
Miel	Nat/Ret				03024		R9	A	>0.42
	Lev/Ret				03027				
Chocolat	Nat/Ret				03026		R9	A	>0.42
	Lev/Ret				03029				

*Attenzione: verificare in fase di ordine il codice e l'imballo (22,5x90 - 15x90 - 30x30 - 20x20)
 *Note: In the ordering phase please check code and packaging 22,5x90 - 15x90 - 30x30 - 20x20
 *Bitteachten: Beim Bestellen bitte die Kodenummer und die Verpackung kontrollieren 22,5x90 - 15x90 - 30x30 - 20x20
 *Attention : Merci de vérifier emballage et la référence au moment de la commande 22,5x90 - 15x90 - 30x30 - 20x20







Riepilogo Gamma

Collection
Serie
Gamme

	Formati Sizes					
		± 10,5	± 10,5	± 10,5	± 10,5	± 10,5
Blanc	Nat/Ret	02046	02052	02076	02083	02088
Gris	Nat/Ret	02045	02051	02075	02082	02087
Naturel	Nat/Ret	02047	02053	02077	02084	02089
Beige	Nat/Ret	02048	02054	02078	02085	02091
Brun	Nat/Ret	02049	02055	02079	02086	02092

*Verificare in fase di ordine lo spessore dei pezzi speciali
 *Check the thickness of special pieces when ordering
 *Bei der Bestellung die Stärke der Formteile prüfen
 *Lors de la commande, vérifier l'épaisseur des pièces spéciales

Packing
Verpackung
Emballage

Formato / Size		± MM	 Pezzi Scatola Pieces/Box Stck/Karton Carreaux/Boîte	 Mq/Scatola Sqmt/Box Qm/Karton M2/Boîte	 Kg/Scatola Kgs/Box Kg/Karton Kg/Boîte	 Scatole/Paletta Boxes/Pallet Karton/Palette Boîte/Palette	 Mq/Paletta Sqmt/Pallet Qm/Pallet M2/Palette	 Kg/Paletta Kgs/Pallet Kg/Pallet Kg/Palette	 Formato Paletta Size Pallet Format Pallet Dim. Palette
20×119,5 (8"×47½") Nat/Ret - Antislip/Ret	P	9,5	5	1,195	26,00	48	57,36	1248	120×80×55
*22,5×90 (9"×36") Nat/Ret	P	9,5	6	1,215	26,00	54	65,61	1404	120×90×85
*15×90 (6"×36") Nat/Ret	P	9,5	9	1,215	26,00	48	58,32	1248	120×90×76
60×119,5 (24"×47½") Chevron Nat/Ret	P	9,5	2	1,434	31,00	30	43,02	930	120×80×75
60×119,5 (24"×47½") Chevron Lev/Ret	P	9,5	2	1,434	32,00	30	43,02	960	120×80×75
*30×30 (12"×12") Linear Nat/Ret	P	10,5	11	0,990	17,50	36	-	-	-
*20×20 (8"×8") Tarsia Nat/Ret	P	10,5	6	0,240	5,00	105	-	-	-
Pezzi Speciali / Special Pieces									
20×120 (8"×48") Step Nat/Ret	P	10,5	4	0,960	22,70	36	-	-	-
6,5×120 (2½"×48") Battiscopa Nat/Ret	P	10,5	8	0,624	14,00	48	-	-	-
7×90 (2¾"×36") Battiscopa Nat/Ret	P	10,5	8	0,504	13,00	48	-	-	-

*Attenzione: verificare in fase di ordine il codice e l'imballo (22,5×90 - 15×90 - 30×30 - 20×20)
 *Note: In the ordering phase please check code and packaging 22,5×90 - 15×90 - 30×30 - 20×20
 *Bitteachten: Beim Bestellen bitte die Kodenummer und die Verpackung kontrollieren 22,5×90 - 15×90 - 30×30 - 20×20
 *Attention : Merci de vérifier emballage et la référence au moment de la commande 22,5×90 - 15×90 - 30×30 - 20×20

Special pieces
Formstücke
Pièces spéciales

Battiscopa Nat/Ret 7×90 – 2¾"×36" ± 10,5

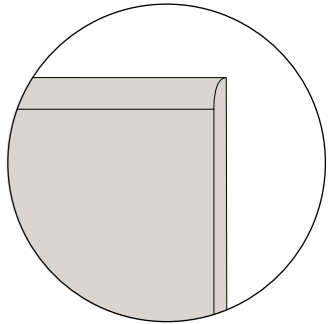
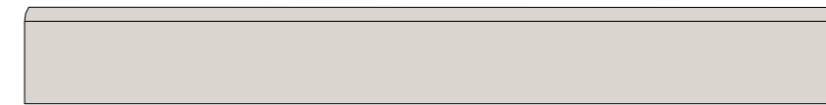

Battiscopa Nat/Ret 6,5×120 – 2½"×48" ± 10,5

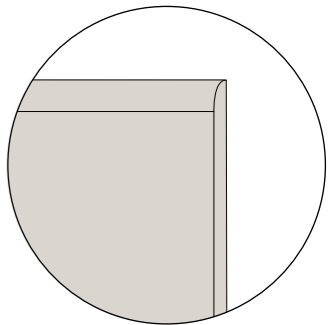
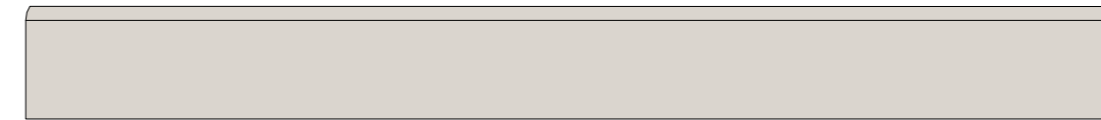

Step Nat/Ret 20×120 – 8"×48" ± 10,5
(becco di civetta tecnico - bullnose edge)

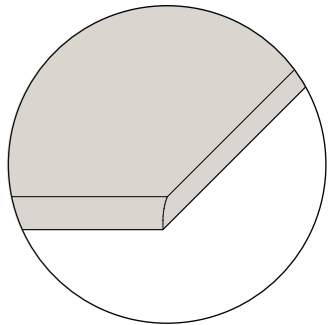

Reading Guide
Leseanleitung
Guide a la lecture

▼
▲
Spessore
Thickness
Stärke
Épaisseur

Variazione nelle sfumature di colore
Color shade variations
Variation der Farbnuancen
Variation des nuances de couleur

V1 Aspetto uniforme
Uniform appearance
Gleichförmiges aussehen
Aspect uniforme

V2 Variazione leggera
Slight variation
Leichte variation
Variation légère

V3 Variazione moderata
Moderate variation
Mäßige variation
Variation modeste

V4 Variazione casuale
Random variation
Zufällige variation
Variation fortuite

Tutti i formati sono nominali.

All sizes are nominal.

Die Formate sind Nennwerte.

Tous les formats sont nominaux.

Gli spessori riportati in questo catalogo sono nominali e possono variare a seconda dei formati e delle finiture.

The thickness mentioned on this catalogue are nominal and can be different according to the sizes and the finishes.

Die in diesem Katalog angegebenen Fliesenstärke sind nominal und können, je nach Format oder Oberfläche, verschieden sein.

Les épaisseurs reportées sur ce catalogue sont nominales et peuvent varier suivant les formats et les finitions.

I colori e le caratteristiche estetiche dei prodotti sono quanto più possibile vicini a quelli reali, nei limiti consentiti dai processi di stampa.

The colours and appearance features of the products are as close as possible to reality, within the limitation of the printing process.

Die Farben und die ästhetischen Eigenschaften der Produkte entsprechen der Wirklichkeit, innerhalb den von dem Druckverfahren erlaubten Grenzen.

Les couleurs et les caractéristiques esthétiques sont fidèles aux couleurs et caractéristiques réelles dans les limites des procédés d'impression.

Una storia tutta italiana

Piemme dal 1962, anno della sua fondazione, è protagonista indiscussa del vero Made in Italy, quello fatto di eccellenza, passione e creatività. Oggi tutti i materiali Piemme sono prodotti con tecnologia d'avanguardia come la decorazione digitale inkjet HD, la cottura in forni ad energia pulita a recupero di calore, la rettifica e levigatura in linea "one roof" e la verifica elettronica dello standard qualitativo.

An all-Italian story

Since 1962, the year of its foundation, Piemme has been the undisputed protagonist of real Made in Italy, that which consists of excellence, passion and creativity. Today all Piemme materials are made using cutting-edge technology such as HD inkjet digital decoration, firing in heat-recycling clean-energy kilns, "one roof" grinding and polishing line and electronic quality standard control.

Eine ganz italienische Geschichte

Seit dem Gründungsjahr 1962 ist Piemme ein unangefochtener Hauptakteur des echten Made in Italy: jenem, das auf Exzellenz, Leidenschaft und Kreativität gründet. Alle Piemme Erzeugnisse werden heute unter Einsatz von Spitzentechnologie produziert, wie zum Beispiel mit der digitalen Inkjet-Dekoration, dem Brennen in Öfen mit grüner Energie und Wärmerückgewinnung, dem Schleifen und Polieren in der Linie „unter einem Dach“ sowie der elektronischen Prüfung des Qualitätsniveaus.

Une histoire toute italienne

Depuis 1962, l'année de sa fondation, Piemme est la protagoniste indiscutée du Made in Italy, basé sur l'excellence, la passion et la créativité. Aujourd'hui toutes les phases du cycle de fabrication Piemme sont issues d'une technologie à l'avant-garde comme la décoration numérique inkjet HD, la cuisson dans des fours à énergie propre et à récupération de chaleur, la rectification et le polissage en ligne "one roof" et la vérification électronique de la qualité.

CERAMICHE PIEMME

FLOOR AND MORE

INDUSTRIE CERAMICHE PIEMME S.P.A.
VIA DEL CROCIALE 42/44, 41042 FIORANO (MO) - ITALY
T. +39 0536.849111 - F. +39 0536.849402
WWW.CERAMICHEPIEMME.IT - INFO@CERAMICHEPIEMME.IT