

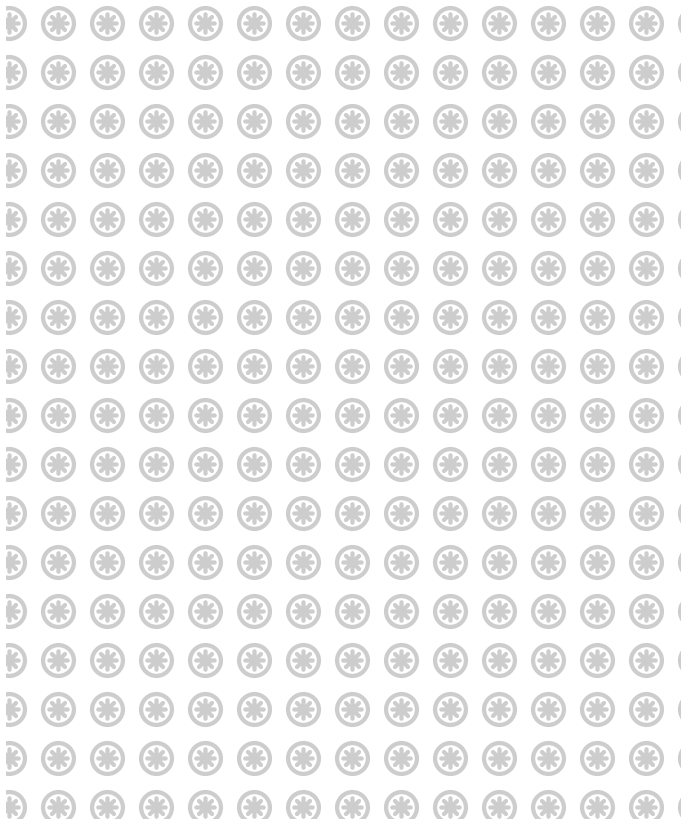

CONCRETE & DESIGN
COLLECTION



PIETRA DI LUNA





Strength & CHARM

PIETRA DI LUNA

BLU, BIANCO, GRADAZIONI DI GRIGIO E BEIGE, UN NERO PROFONDO CON BRILLANTI MICROGLITTER, PIETRA DI LUNA È FLUIDA, EMOTIVA, MISTERIOSA.

UNA COLLEZIONE VERSATILE CHE SI PROPONE COME IL MEZZO PER DARE FORMA ALLA PERSONALITÀ DI CHI LA SCEGLIE PER VESTIRE GLI AMBIENTI CON ATMOSFERE MODERNE ED HIGH TECH OPPURE ROMANTICHE E RETRÒ.

UNA STRUTTURA SUPERFICIALE SAPIENTEMENTE LAVORATA PER UN EFFETTO PIETRA, VELLUTATA AL TATTO NELLA FINITURA “VELVET”, LA RENDONO UNA COLLEZIONE UNICA, FUORI DALLE CONVENZIONI, FUORI DAL TEMPO.

Blue, white, in shades of grey and beige, a deep black with shiny micro glitter, PIETRA DI LUNA is fluid, thrilling, mysterious.

A versatile collection that aims to be the means to give shape to the personality of those who choose it, dressing environments with a modern and high-tech atmosphere or a romantic and retro one.

A surface structure skilfully worked to obtain a stone effect, velvety to the touch in the 'velvet' finish, make it a unique, unconventional, timeless collection.

Bleu, blanc, dans les nuances de gris et de beige, un noir profond avec des paillettes microglitter, PIETRA DI LUNA est fluide, émotif, mystérieux. Une collection flexible proposée comme un moyen pour donner forme à la personnalité de ceux qui la choisissent pour habiller les espaces avec des atmosphères modernes et high-tech ou bien romantiques et rétro. Sa structure superficielle savamment travaillée pour un effet pierre, veloutée au toucher dans la finition "velvet", fait d'elle une collection unique, non conventionnelle, hors du temps.

Blau, weiß, in Grau- und Beigeabstufungen, ein tiefes Schwarz mit leuchtendem Mikroglitter - PIETRA DI LUNA ist fließend, emotional und geheimnisvoll.

Eine vielseitige Kollektion als Mittel, der Persönlichkeit des Bewohners Gestalt zu verleihen, wenn er die Räume mit modernen und hochtechnologischen oder romantischen und Retro-Atmosphären schmückt. Eine gekonnt bearbeitete Oberflächenstruktur mit Steineffekt, die sich in der Ausführung „Velvet“ samtig anfühlt, macht sie zu einer einzigartigen Kollektion, unkonventionell und zeitlos.

Matter & LIGHT

LE SUPERFICI DELLA SERIE “PIETRA DI LUNA” EMETTONO SUGGESTIVI EFFETTI DI LUCCICHIO GENERATI DA SPECIALI MICROMINERALI RIFLETTENTI/OPALESCENTI PRESENTI NELLO SMALTO.

Thanks to special reflecting and opalescent micro-minerals present in their glaze, “PIETRA DI LUNA” surfaces produce alluring sparkling effects.

Les surfaces de la série «PIETRA DI LUNA» émettent des effets chatoyants suggestifs générés par des micro-minéraux réfléchissants/opalescents spéciaux présents dans l'émail.

Die Oberflächen der Serie „PIETRA DI LUNA“ zeigen auffallend schimmernde Effekte, die durch spezielle reflektierende/opalisierende Mikromineralien in der Emaille erzeugt werden.

La finitura “Velvet” è caratterizzata da un morbido effetto tattile.

“Velvet” finish is characterised by a pleasantly smooth touch.

La finitura “Velvet” se caractérise par un effet tactile doux.

Die Oberfläche „Velvet“ zeichnet sich durch ihre sanfte Haptik aus.

Colors & ARMONY

BLANC

ARGENT

GRIS

NOIR

BEIGE

BLEU

NOIR



RIVESTIMENTO . WALL: Collection DECORS, FOREST 120x280 Nat. Ret.
PARETE CAMINO . FIREPLACE WALL: MANDALA BLANC 45x90 Lucidato Ret.
PAVIMENTO . FLOOR: NOIR 90x90 Velvet Ret.



RIVESTIMENTO . WALL: Collection DECORS, FOREST 120x280 Nat. Ret.
PARETE CAMINO . FIREPLACE WALL: MANDALA BLANC 45x90 Lucidato Ret.
PAVIMENTO . FLOOR: NOIR 90x90 Velvet Ret.

BLANC



RIVESTIMENTO - WALL: LEAVES 90x90 Lucidato Ret. - BLANC 90x90 / 45x90 Velvet Ret.
PAVIMENTO - FLOOR: BLANC 90x90 Velvet Ret.



RIVESTIMENTO . WALL: LEAVES 90x90 Lucidato Ret. - BLANC 90x90 / 45x90 Velvet Ret.
PAVIMENTO . FLOOR: BLANC 90x90 Velvet Ret.

BEIGE



ARGENT



GRIS





**UNA STRUTTURA SUPERFICIALE
SAPIENTEMENTE LAVORATA PER UN
EFFETTO PIETRA, VELLUTATA AL TATTO
NELLA FINITURA “VELVET”, LA RENDONO
UNA COLLEZIONE UNICA, FUORI DALLE
CONVENZIONI, FUORI DAL TEMPO.**

A surface structure skilfully worked to obtain a stone effect, velvety to the touch in the ‘velvet’ finish, make it a unique, unconventional, timeless collection.

Sa structure superficielle savamment travaillée pour un effet pierre, veloutée au toucher dans la finition “velvet”, fait d’elle une collection unique, non conventionnelle, hors du temps.

Eine gekonnt bearbeitete Oberflächenstruktur mit Steineffekt, die sich in der Ausführung „Velvet“ samtig anfühlt, macht sie zu einer einzigartigen Kollektion, unkonventionell und zeitlos.

BLEU

TOUR
CHOCOLATE



FORME RAFFINATE E DECORI PREZIOSI PER PROGETTARE AMBIENTI DA SOGNO.

ELEGANT FORMS AND FINE DECORATIONS
TO DESIGN DREAM ENVIRONMENTS.

DES FORMES RAFFINÉES ET DES DÉCORATIONS PRÉCIEUSES
POUR CONCEVOIR DES ENVIRONNEMENTS DE RÊVE.

RAFFINIERTE FORMEN UND KOSTBARE DEKORATIONEN
ZUR GESTALTUNG TRAUMHAFTER UMGEBUNGEN.

Design & ELEGANCE

Una ricca gamma di decori completa la collezione Pietra di Luna. Ottenuti dai colori di fondo, sono disponibili Mosaici con tessere di 5 cm, il modulo multicolore Cubics composto da tessere esagonali e il modulo Muretto, ideali per personalizzare con stile pavimenti e rivestimenti.

A rich assortment of decorations completes the "Pietra di Luna" collection. Obtained from the background colours, mosaics are available with 5 cm tiles, as are the multi-coloured cubics module made up of hexagonal tiles and the "muretto" module, ideal for customising floors and walls in style.

Une riche gamme de décors complète la collection « Pietra di Luna ». Obtenus à partir des couleurs de fond, les mosaïques se déclinent en carreaux de 5 cm, le module multicolore cubics composé de carreaux hexagonaux et le module muretto, idéal pour personnaliser sols et murs avec style.

Eine breite Palette von Dekoren vervollständigt die Kollektion „Pietra di Luna“. Von den Hintergrundfarben ausgehend gibt es Mosaiksteine mit 5 cm großen Mosaiksteinen, das mehrfarbige Modul Cubics, das aus sechseckigen Mosaiksteinen besteht, und das Modul Muretto, das ideal für die individuelle Gestaltung von Böden und Wänden ist.



RIVESTIMENTO . WALL: Mosaico (5x5) NOIR 30x30 Nat. Ret. - NOIR 45x90 Nat. Ret.
PAVIMENTO . FLOOR: NOIR 90x90 Nat. Ret.



RIVESTIMENTO . WALL: Muretto BLANC 15x60 Nat. Ret. - BLANC 45x90 Nat. Ret.
PAVIMENTO . FLOOR: BLANC 90x90 Nat. Ret.



Mosaico CUBICS A 30x39 Nat. Ret.
ARGENT 45x90 Nat. Ret.

MANDALA

Ai fondi ed ai mosaici, si affiancano 4 differenti soggetti decorativi pensati per definire il carattere dei tuoi ambienti.

Effetti raffinati per interpretare gli spazi con emozionanti soluzioni decorative.

The backgrounds and mosaics are supported by 4 different decorative solutions, created to define the character of your environments. Refined effects to interpret spaces with evocative, decorative solutions.

4 sujets décoratifs différents conçus pour définir le caractère de vos pièces s'ajoutent aux fonds et aux mosaïques. Des effets raffinés pour interpréter les espaces par des solutions décoratives émouvantes.

Zusätzlich zu den Hintergründen und Mosaiken gibt es 4 verschiedene dekorative Motive, die den Charakter Ihrer Umgebung bestimmen. Raffinierte Effekte, um Räume mit aufregenden dekorativen Lösungen zu interpretieren.



MANDALA, un decoro che libera nello spazio forme circolari e sinuose, un decoro levigato in cresta con applicazioni superficiali semitrasparenti dagli eleganti riflessi cangianti per ambienti estremamente raffinati.

MANDALA: a free-flowing pattern of sinuous, circular forms, a polished ridges décor with elegant iridescent reflections of semitransparent applications for especially refined spaces.

MANDALA, une décoration qui libère des formes circulaires et sinueuses dans l'espace, polie avec des applications semi-transparentes avec des reflets irisés élégants pour des environnements extrêmement raffinés.

MANDALA, eine Dekoration, die kreisförmige und gerundete Formen im Raum freisetzt, eine halbrtransparente Dekoration, die zu einem Wappern mit eleganten schillernden Reflexen für äußerst raffinierte Umgebungen geeignet ist.



RIVESTIMENTO . WALL: MANDALA BLANC 45x90 Lucidato Ret.
PAVIMENTO . FLOOR: NOIR 90x90 Velvet. Ret.

IRIS

Le forme aggraziate delle orchidee danno vita a IRIS, un decoro dalla superficie naturale in grado di racchiudere in sé il caleidoscopio dei colori della natura nella loro forma più viva e brillante.

The graceful shapes of orchids give rise to IRIS, a decoration with a natural surface that encapsulates a kaleidoscope of natural colours in their most vivid and brilliant form.

Les formes gracieuses des orchidées donnent vie à IRIS, une décoration avec une surface naturelle capable d'enfermer le kaléidoscope des couleurs de la nature dans leur forme la plus vive et la plus brillante.

Die anmutigen Formen der Orchideen erwecken die IRIS zum Leben, eine Dekoration mit einer natürlichen Oberfläche, die das Kaleidoskop der Farben der Natur in ihrer lebhaftesten und brillantesten Form wiedergibt.

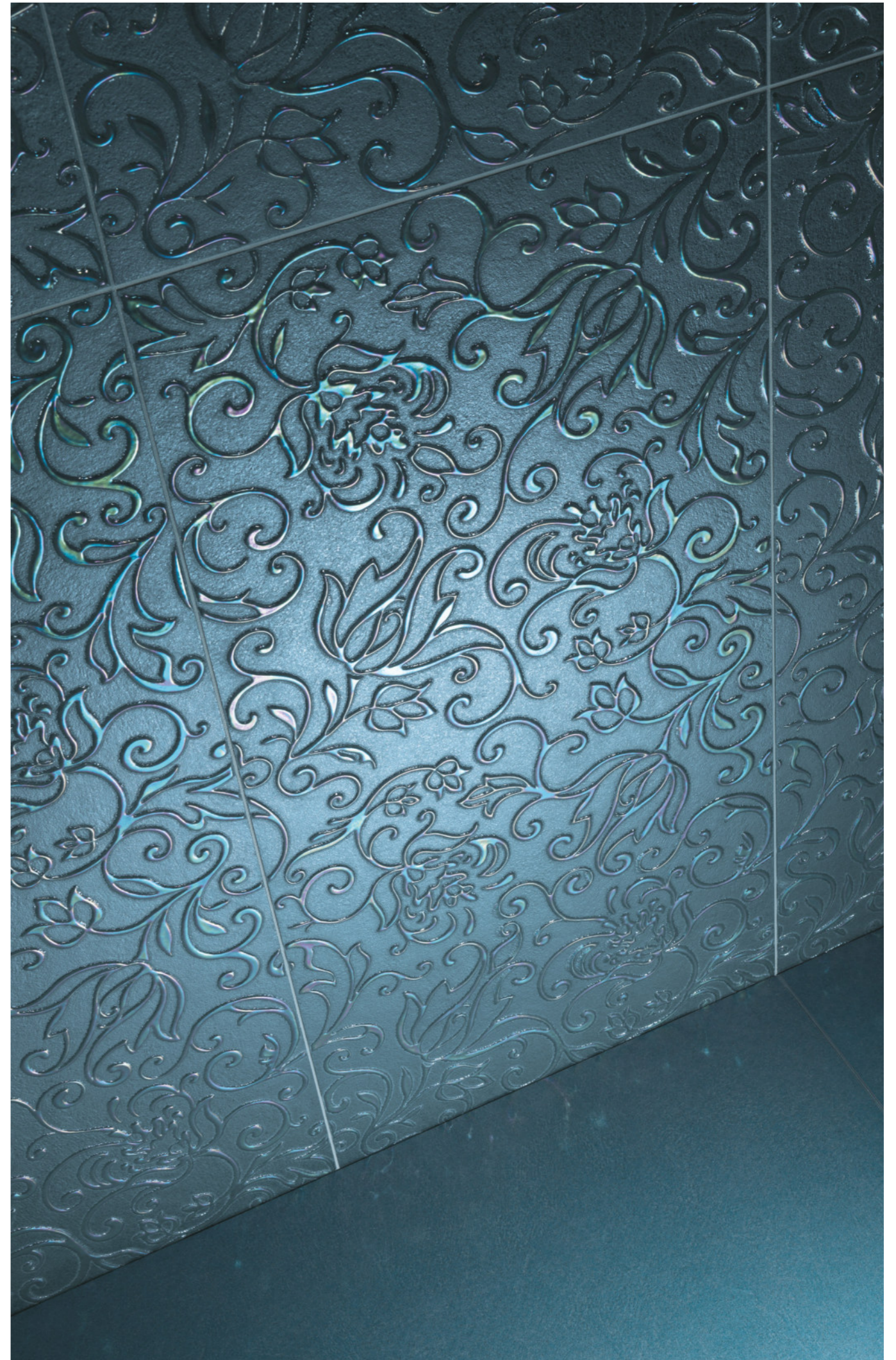
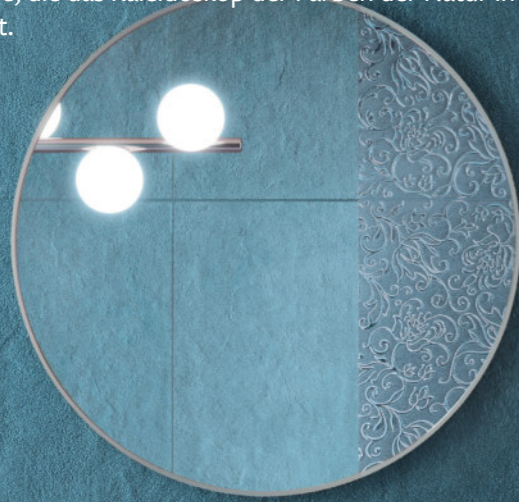

RIVESTIMENTO . WALL: IRIS BLEU 45x90 Lucidato Ret. - BLEU 45x90 Nat. Ret.
PAVIMENTO . FLOOR: BLEU 90x90 Nat. Ret.

VICHY

VICHY, una texture astratta reinterpretata secondo i nostri canoni di stile, dove la storia incontra la natura, dove la materia fusa in superficie viene levigata in cresta per creare luce attraverso l'ombra e la profondità.

VICHY, an abstract texture re-interpreted through our style criteria, where history meets nature, where the molten surface matter has its ridges polished to create light through shadow and depth.

VICHY, une texture abstraite sans continuité réinterprétée selon nos canons de style, où l'histoire rencontre la nature, où la matière fondue à la surface est lissée pour créer de la lumière à travers l'ombre et la profondeur.

VICHY, eine abstrakte Textur, die nach unseren Stilregeln neu interpretiert wird, wo Geschichte auf Natur trifft, wo die auf der Oberfläche geschmolzene Materie anpoliert wird, um Licht durch Schatten und Tiefe zu schaffen.



LEAVES

La molteplicità dei colori delle foglie in autunno ispira il LEAVES: un decoro dove tutti i colori della collezione trovano rifugio, dove l'essenza della serie trova esaltazione e corposità, carattere e stile, brillantezza ed allegria.

The multitude of colours of leaves in autumn inspires LEAVES: a decoration where all the colours of the collection find refuge, where the essence of the series finds exaltation and body, character and style, brilliance and joy.

La multiplicité des couleurs des feuilles d'automne inspire LEAVES: une décoration qui réunit toutes les couleurs de la collection, où l'essence de la série trouve exaltation et corps, caractère et style, brillance et gaieté.

Die Farbvielfalt der Blätter im Herbst inspiriert das LEAVES: eine Dekoration, in der alle Farben der Kollektion Zuflucht finden, in der die Essenz der Serie in Erhabenheit und Form, Charakter und Stil, Schein und Harmonie schmilzt.



RIVESTIMENTO . WALL: LEAVES 90x90 Lucidato Ret. - BLANC 90x90 / 45x90 Velvet Ret.
PAVIMENTO . FLOOR: BLANC 90x90 Velvet Ret.



PIETRA DI LUNA

Gres porcellanato colorato in massa.
Full-body coloured porcelain stoneware.
Grès cérame coloré dans la masse.
In der Masse gefärbtes Feinsteinzeug.

SPESSORE . THICKNESS . EPAISSEUR . STÄRKE
10 mm

 **Tagina**
ITALY'S BEST SURFACES

FORMATI
Sizes / Formats / Formate

10 mm . 90x90 - 35½"x35 ½" / 45x90 - 18"x35 ½"

Gres porcellanato colorato in massa. Full-body coloured porcelain stoneware. Grès cérame coloré dans la masse. In der Masse gefärbtes Feinsteinzeug.

COLORI
Colours / Couleurs / Farben



NOIR

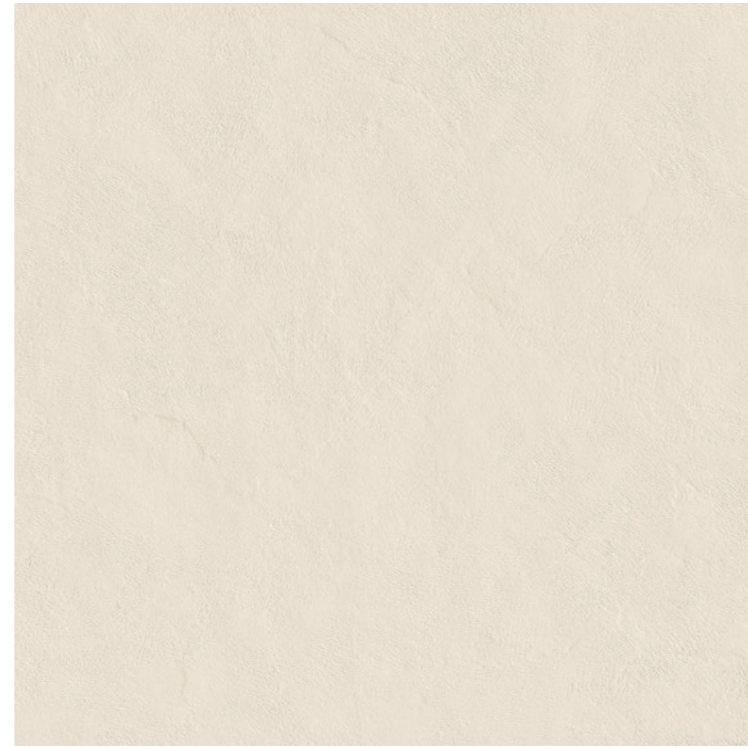

BEIGE



GRIS



BLANC



ARGENT

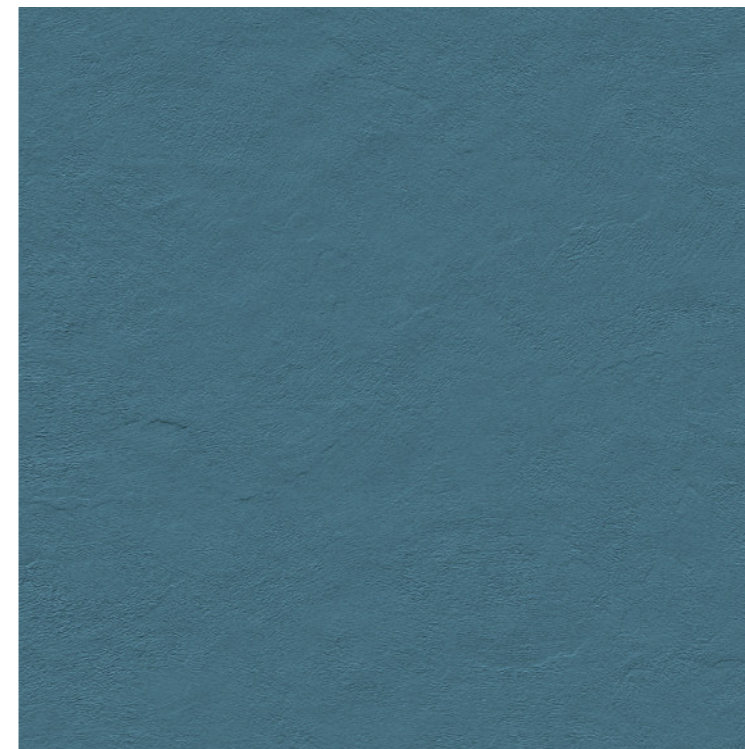

BLEU

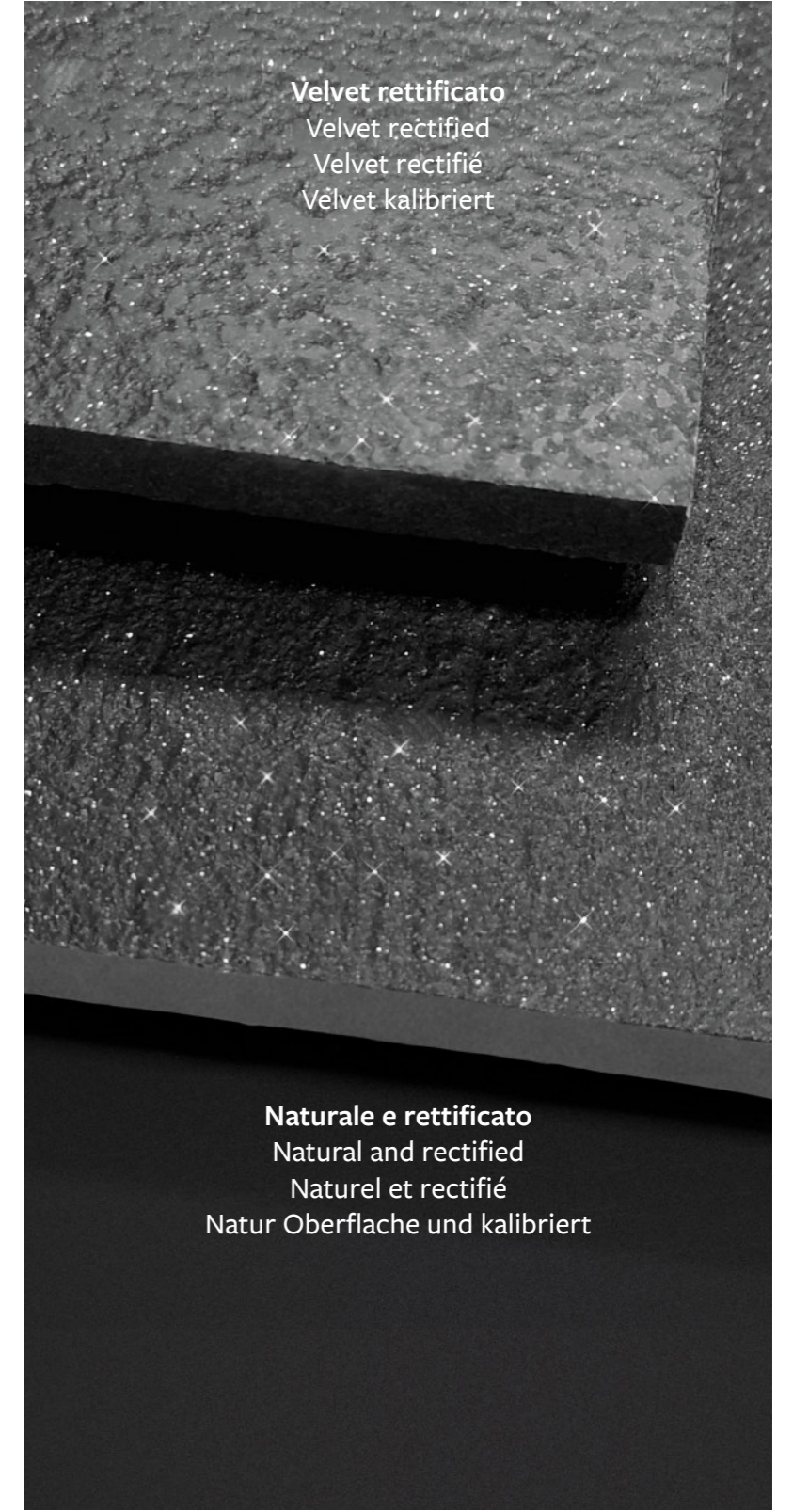

Velvet rettificato
Velvet rectified
Velvet rectifié
Velvet kalibriert

Naturale e rettificato
Natural and rectified
Naturel et rectifié
Natur Oberfläche und kalibriert

Spessore . Thickness . Epaisseur . Stärke - 10 mm

Gres porcellanato colorato in massa. Full-body coloured porcelain stoneware. Grès cérame coloré dans la masse. In der Masse gefärbtes Feinsteinzeug.

TABELLA RIEPILOGATIVA

Summary table
Tableau récapitulatif
Zusammenfassende Tabelle



90x90
35 1/2"x35 1/2"



45x90
18"x35 1/2"



Mosaico (5x5)
30x30
12"x12"



Muretto
15x60
6"x24"



Mosaico Cubics
30x39
12"x15 1/2"



**** * Copriscipigolo triangolare**
1,4x90
1/2"x35 1/2"



Angolo Copriscipigolo triangolare
1,4x1,4
1/2"x1/2"



Battiscopa
7,2x90
3"x35 1/2"



*** Gradino a C**
33x90x3,2h
13"x35 1/2"x1 1/4"h



*** Ang. Gradino a C - DX**
33x90x3,2h
13"x35 1/2"x1 1/4"h



*** Ang. Gradino a C - SX**
33x90x3,2h
13"x35 1/2"x1 1/4"h

Spessore - Thickness - Epaisseur - Stärke		10 mm	10 mm	10 mm	10 mm	10 mm	10 mm	10 mm	10 mm	10 mm	10 mm	10 mm	10 mm	
NOIR	◇ Velvet Ret.	122009	122073	122210	122230				122510	122531	122160	122310	122330	122351
	□ Nat. Ret.	122019	122083	122211	122231		122242		122511	122532	122161	122311	122331	122352
BLANC	◇ Velvet Ret.	122001	122069	122200	122220				122500	122521	122150	122300	122320	122341
	□ Nat. Ret.	122015	122079	122201	122221	122241			122501	122522	122151	122301	122321	122342
BEIGE	◇ Velvet Ret.	122003	122070	122206	122226				122506	122527	122156	122306	122326	122347
	□ Nat. Ret.	122016	122080	122207	122227	122241			122507	122528	122157	122307	122327	122348
ARGENT	◇ Velvet Ret.	122007	122072	122202	122222				122502	122523	122152	122302	122322	122343
	□ Nat. Ret.	122018	122082	122203	122223	122241			122503	122524	122153	122303	122323	122344
GRIS	◇ Velvet Ret.	122005	122071	122204	122224				122504	122525	122154	122304	122324	122345
	□ Nat. Ret.	122017	122081	122205	122225		122242		122505	122526	122155	122305	122325	122346
BLEU	◇ Velvet Ret.	122021	122085	122208	122228				122508	122529	122158	122308	122328	122349
	□ Nat. Ret.	122020	122084	122209	122229		122242		122509	122530	122159	122309	122329	122350
CODICE PREZZO - PRICE CODE CODE PRIX - PREISGRUPPE	◇ Velvet Ret.	170F	170F	280F	300F				116P	62P	26P	310P	418P	418P
	□ Nat. Ret.	130F	130F	280F	300F	402F	402F		116P	62P	26P	310P	418P	418P
Pallet														
		94x120	94x120	80x120	80x120	80x120	80x120				80x120	80x120	80x120	80x120
N°														
m ²														
** Kg														
x	2	3	11	3	6	6		6		8	2	1	1	
m ² x	1,62	1,22	0,99	0,27	0,66	0,66								
Kg x	35	27	20	6	14,6	14,6		2		14,5	16,5	8,2	8,2	
x	20	32												
m ² x	32,4	39,04												
** Kg x	720	884												
h x	70	60												
Imballo (tara) - Packaging (tare)	20	20	20	20	20	20				(20)	(20)	(20)	(20)	

I pesi riportati in tabella sono indicativi e potrebbero essere soggetti a leggere variazioni.
The weights stated in the chart may undergo slight changes for production reasons.
Les poids indiqués dans le tableau peuvent subir de légères variations pour des raisons de production.
Die in der Tabelle angegebenen Gewichte können aus Produktionsgründen geringfügigen Abweichungen unterliegen.

Non si garantisce l'abbinabilità tra fondi di spessori diversi e tra fondo e pezzo speciale.
It is not guaranteed that background tiles with different thicknesses can be used together, nor is it guaranteed for background tiles and trims.
Nous ne garantissons pas la possibilité de combiner des carrelages de sol de différentes épaisseurs et un carrelage de sol avec une pièce spéciale.
Die Kombinierbarkeit von Fliesen unterschiedlicher Stärke sowie zwischen Fliese und Formteil kann nicht garantiert werden.

* A disposizione solo su richiesta. Tempi di consegna 30 gg.
Available upon request only. Delivery terms: 30 days.
Disponible seulement sur requête. Délais de livraison: 30 jours.
Verfügbar auf Anfrage. Lieferzeit: 30 Tage.

** Il peso è comprensivo dell'imballo.
The total weight includes the packaging.
Le poids comprend aussi l'emballage.
Das Gesamtgewicht enthält auch die Verpackung.

*** Vendita a scatola completa.
Full box sale.
Vente à la boîte complète.
Volle Kartons.

□ Naturale e rettificato.
Natural and rectified.
Naturel et rectifié.
Natur Oberfläche und kalibriert.

◇ Velvet rettificato
Velvet rectified
Velvet rectifié
Velvet kalibriert

Spessore . Thickness . Epaisseur . Stärke - 10 mm

Gres porcellanato colorato in massa. Full-body coloured porcelain stoneware. Grès cérame coloré dans la masse. In der Masse gefärbtes Feinsteinzeug.

MANDALA

45x90 - 18"x35 1/2"

NOIR

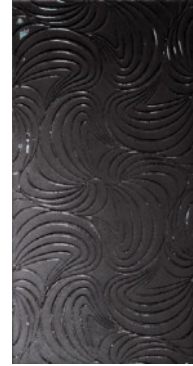

BLANC

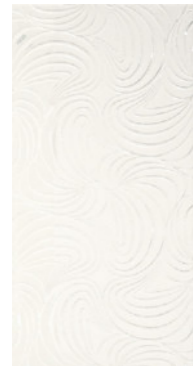

VICHY

45x90 - 18"x35 1/2"

NOIR



BLANC

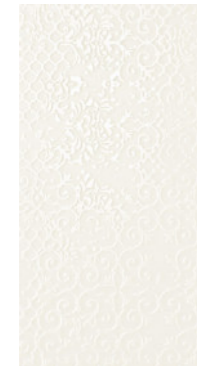

GRIS



BEIGE



ARGENT



BLEU



IRIS

45x90 - 18"x35 1/2"

NOIR



BLANC

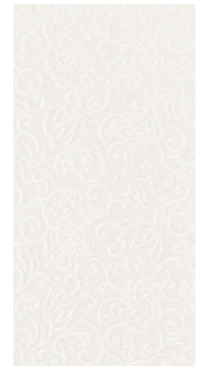

GRIS



BEIGE

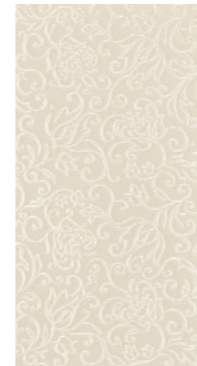

ARGENT

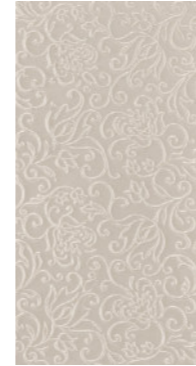

BLEU



LEAVES

90x90 - 35 1/2"x35 1/2"



MOSAICO (5x5)

30x30 - 12"x12"

NOIR

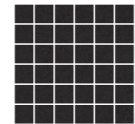

BLANC

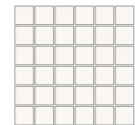

GRIS

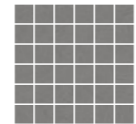

BEIGE

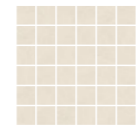

ARGENT

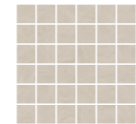

BLEU



MOSAICO CUBICS

30x39 - 12"x15 1/2"

A

BLANC
BEIGE
ARGENT

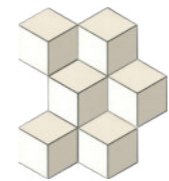

B

NOIR
GRIS
BLEU



LEAVES
90x90
35 1/2"x35 1/2"



MANDALA
45x90
18"x35 1/2"



VICHY
45x90
18"x35 1/2"



IRIS
45x90
18"x35 1/2"

Spessore - Thickness - Epaisseur - Stärke		10 mm	10 mm	10 mm	10 mm
NOIR	○ Lucidato Ret.	-	122407	122426	122416
	□ Nat. Ret.	122401	-	-	-
BLANC	○ Lucidato Ret.	-	122402	122421	122411
	□ Nat. Ret.	122401	-	-	-
BEIGE	○ Lucidato Ret.	-	-	122424	122414
	□ Nat. Ret.	122401	-	-	-
ARGENT	○ Lucidato Ret.	-	-	122422	122412
	□ Nat. Ret.	122401	-	-	-
GRIS	○ Lucidato Ret.	-	-	122423	122413
	□ Nat. Ret.	122401	-	-	-
BLEU	○ Lucidato Ret.	-	-	122425	122415
	□ Nat. Ret.	122401	-	-	-
CODICE PREZZO - PRICE CODE		○ Lucidato Ret.	420P	335P	410P
CODE PRIX - PREISGRUPPE		□ Nat. Ret.	700P		
		Pallet	Pallet	Pallet	Pallet
N°					
m²					
** Kg					
		1	2	2	2
m² x		0,81	0,81	0,81	0,81
Kg x		18	18	18	18
m² x					
** Kg x					
h x					
Imballo (tara) - Packaging (tare)					

MURETTO

15x24 - 6"x24"

NOIR



BLANC



GRIS



BEIGE



ARGENT



BLEU



□ Naturale e rettificato.
Natural and rectified.
Naturel et rectifié.
Natur Oberfläche und kalibriert.

○ Lucidato e rettificato.
Glossy/Polished and rectified.
Brillant et rectifié.
Glossy/Shiny und kalibriert

PEZZI SPECIALI: MASSIMA CURA IN OGNI DETTAGLIO

Special pieces: the utmost care in every detail.

Pièces spéciales : le soin maximal dans le moindre détail.

Spezialteile: maximale Sorgfalt in jedem Detail.

IL FASCINO TRADIZIONALE DEL GRADINO A "C"

The traditional appeal of the "C" step.

Le charme traditionnel de l'étape « C »

Der traditionelle Charme der „C“-Stufe.

Tagina pone attenzione a tutte le componenti architettoniche degli spazi da abitare. Ai gradini sono dedicati pezzi speciali appositamente progettati per ottenere il massimo risultato estetico. La gamma comprende un elemento "gradino a C" al quale si possono affiancare gli elementi che completano gli angoli sinistro e destro.

Tagina takes great care over all the architectural elements of the living spaces. Special pieces are used for the stairs, specially designed to obtain the maximum aesthetic result. The range includes a "C-step" element which can be combined with the elements that complete the left and right corners.

Tagina prête attention à toutes les composantes architecturales des espaces de vie. Les étapes sont dédiées à des pièces spéciales spécialement conçues pour obtenir un résultat esthétique maximal. La gamme comprend un élément « marche en C » auquel vous pouvez assortir les autres éléments qui complètent les angles gauche et droit.

Tagina achtet auf alle architektonischen Komponenten der Wohnräume. Den Stufen sind Spezialteile gewidmet, um ein optimales ästhetisches Ergebnis zu erzielen. Das Sortiment umfasst ein „C-Stufen-Element“, das durch Elemente zur Vervollständigung der linken und rechten Ecke ergänzt werden kann.

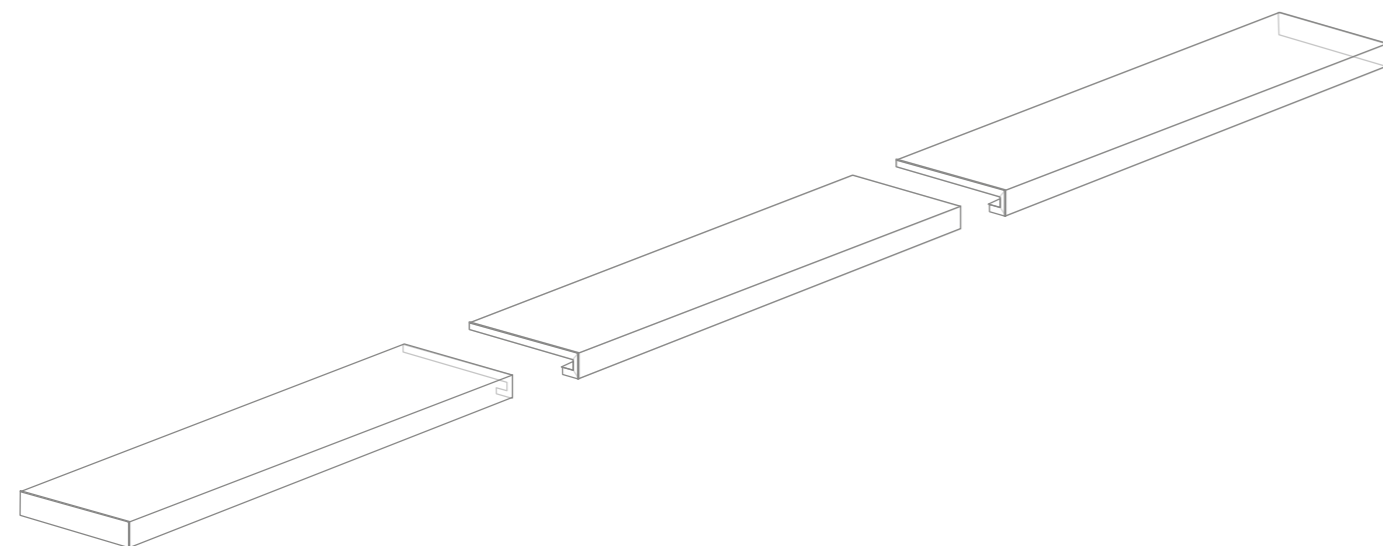

IL "COPRISPIGOLO TRIANGOLARE"

The "triangular edge cover".

Le « cache-arête triangulaire »

„Dreieckiger Kantenschutz“

La gamma della collezione include l'elemento "Coprispigolo triangolare" e "Angolo Coprispigolo triangolare". Consentono di risolvere con eleganza e semplicità problematiche legate alla congiunzione delle lastre in presenza di spigoli e angoli. È possibile adottare questa soluzione sia a rivestimento che a pavimento ad esempio per realizzare gradini o per comporre volumi geometrici.

The range of the collection includes the "Triangular edge cover and triangular corner edge cover" element. They allow problems encountered to be solved elegantly and simply when joining slabs where there are edges and corners. It is possible to adopt this solution both for cladding and flooring, e.g. to create steps or compose geometric volumes.

La gamme de la collection comprend l'élément « Cache-arête triangulaire et Angle Cache-arête Triangulaire ». Ils permettent de résoudre avec élégance et simplicité les problèmes liés à l'assemblage des dalles en présence de bords et de coins. Il est possible d'adopter cette solution aussi bien pour le revêtement que pour le dallage, par exemple pour créer des marches ou composer des volumes géométriques.

Das Sortiment der Kollektion umfasst das Element „Dreieckiger Kantenschutz und Dreieckige Eckabdeckung“. Beide Elemente ermöglichen, mit Eleganz und Einfachheit alle Probleme zu lösen, die mit dem Zusammenfügen der Platten bei Vorhandensein von Kanten und Ecken zusammenhängen. Diese Lösung kann sowohl für Verkleidungen als auch für Böden verwendet werden, beispielsweise um Stufen oder geometrische Volumen zu schaffen.

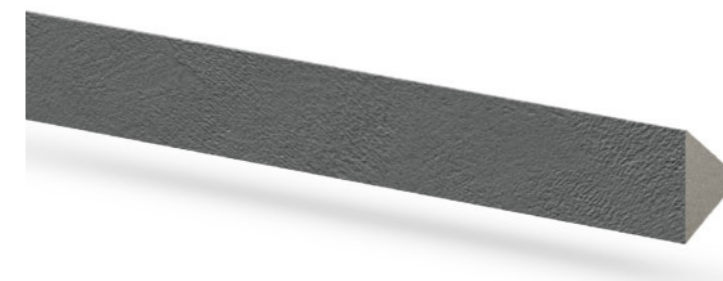

SUGGERIMENTI PER ABBINARE COLORI E STILI TAGINA



TIPS FOR MATCHING
COLOURS AND TAGINA
STYLES.

CONSEILS POUR FAIRE
CORRESPONDRE LES
COULEURS ET LES
STYLES TAGINA.

TIPPS FÜR DIE
KOMBINATION VON
TAGINA-FARBEN UND
-STILEN.

	BLANC	ARGENT	GRIS	BEIGE	BLEU	NOIR
CONCRETE & DESIGN PIETRA DI LUNA CONCRETA	 TERRA GRIGIO CHIARO GRIGIO SCURO	 TERRA GRIGIO SCURO	 GRIGIO CHIARO GRIGIO SCURO	 TERRA	 TERRA	 TERRA GRIGIO SCURO
CONCRETE & DESIGN PIETRA DI LUNA APOGEO	 WHITE	 GREY ANTHRACITE	 GREY BLACK	 WHITE BLACK		 GREY BLACK
MARBLE & ONIX PIETRA DI LUNA PATAGONIA	 CASHMERE	 CASHMERE TURCHESE		 CAFFÈ ZAFFIRO	 BIANCO	 CAFFÈ
MARBLE & ONIX PIETRA DI LUNA STATUARIO		 STATUARIO		 STATUARIO		 STATUARIO
STONE & CLASSIC PIETRA DI LUNA PIETRA REGALE	 CHIANALE OSTANA	 ELVA	 RIVOLI MURAZZANO	 RIVOLI	 OSTANA	 RIVOLI MURAZZANO
WOOD PIETRA DI LUNA EVOQUE	 KORINA	 DOUGLAS BAHIA	 KORINA	 ROVERE	 BAHIA	 KORINA BAHIA
Colore consigliato per la Fuga Recommended joint colour. Couleur d'échappement recommandée. Empfohlene Farbe für die Fuge.	 RAL 9003 NCS 0510-R	 RAL 7044 NCS 4500-N	 RAL 7046 NCS S 4502-B	 RAL 9003 NCS 1502-Y	 RAL 7031 NCS 6502-G	 RAL 7021 NCS 8502-Y

CARATTERISTICHE TECNICHE

Technical features / Caractéristiques techniques / Technische Eigenschaften

GRES PORCELLANATO COLORATO IN MASSA

Full-body coloured porcelain stoneware / Grès cérame coloré dans la masse / In der Masse gefärbtes Feinsteinzeug.

100% Made in Italy



CARATTERISTICA Specification Caractéristique Eigenschaft	NORMA Standards Norme Norm	RISULTATO PROVA Test results Resultats des essais Ergebnisse
Classificazione prodotto Product classification Classification produit Produktklassifizierung	UNI EN 14411- Allegato G ISO 13006 UNI EN 14411- Appendix G ISO 13006 UNI EN 14411- Appendice G ISO 13006 UNI EN 14411- Anhang G ISO 13006	Gruppo B1a GL Group B1a GL Groupe B1a GL Gruppe B1a GL
Caratteristiche dimensionali e d'aspetto Dimensional characteristics Caractéristiques dimensionnelles Abmessungen	UNI EN ISO 10545-2	Conforme alla norma. Complies with the standards. Conforme aux normes. Anforderungenerfüllt.
Assorbimento di acqua Water absorption Absorption d'eau Wasseraufnahme	UNI EN ISO 10545-3	Conforme alla norma. Complies with the standards. Conforme aux normes. Anforderungenerfüllt.
Resistenza alla flessione Breaking stress Résistance à la flexion Biegefestigkeit	UNI EN ISO 10545-4	Conforme alla norma. Complies with the standards. Conforme aux normes. Anforderungenerfüllt.
Sforzo di rottura Breaking stress Effort de rupture Bruchkraft		Conforme alla norma. Complies with the standards. Conforme aux normes. Anforderungenerfüllt.
Resistenza all'abrasione delle piastrelle non smaltate Deep abrasion resistance of unglazed tiles Résistance à l'abrasion profonde des carreaux non émaillés Beständig gegenüber Tiefenabrieb der unglasierten Fliesen	UNI EN ISO 10545-6	-
Resistenza all'abrasione delle piastrelle smaltate Abrasion resistance of glazed tiles Résistance à l'abrasion des carreaux émaillés Abriebfestigkeit der glasierten Fliesen	UNI EN ISO 10545-7	Secondo quanto dichiarato. As stated by the Company. D'après déclaration de l'établissement. Entsprechend der Angaben des Unternehmens.
Dilatazione termica lineare Linear thermal expansion Dilatation thermique linéaire Lineare Wärmedehnung	UNI EN ISO 10545-8	6x10 ⁻⁶ C ⁻¹
Resistenza agli sbalzi termici Thermal shock resistance Résistance aux écarts thermiques Beständigkeit gegenüber Temperaturschwankungen	UNI EN ISO 10545-9	Resistente. Resistant. Résiste. Erfüllt.
Resistenza al cavillo Crazing resistance Résistance aux craquelures Beständigkeit gegenüber Glasrissen	UNI EN ISO 10545-11	Resistente. Resistant. Résiste. Erfüllt.
Resistenza al gelo Frost resistance Résistance au gel Frostbeständigkeit	UNI EN ISO 10545-12	Resistente. Resistant. Résiste. Erfüllt.
Resistenza ai prodotti chimici Chemical resistance Résistance aux produits chimiques Beständig gegenüber Chemikalien	UNI EN ISO 10545-13	Resistente. Resistant. Résiste. Erfüllt.
Resistenza alle macchie Stain resistance Résistance aux taches Beständigkeit gegenüber Flecken	UNI EN ISO 10545-14	Resistente. Resistant. Résiste. Erfüllt.
Stabilità dei colori alla luce Colour stability upon exposure to light Stabilité des couleurs à la lumière Stabilität der Farben gegenüber dem Licht	DIN 51094	Conforme alla norma. Complies with the standards. Conforme aux normes. Anforderungenerfüllt.
Resistenza alla scivolosità Friction coefficient (slip level) Coefficient de friction (glissance) Reibungskoeffizient (Glätte)	DIN 51130	A richiesta. / Available on request. / Sur demande. / Anforderungenerfüllt.
	DIN 51097	A richiesta. / Available on request. / Sur demande. / Anforderungenerfüllt.
	ASTM C1028 C.O.F.	A richiesta. / Available on request. / Sur demande. / Anforderungenerfüllt.
	B.C.R.	A richiesta. / Available on request. / Sur demande. / Anforderungenerfüllt.
	DCOF (BOOT 3000 -section 9.6 ANSI 137.2012)	A richiesta. / Available on request. / Sur demande. / Anforderungenerfüllt.
Resistenza al sale Salt resistance Résistance au sel Beständigkeit gegenüber Salz	NaCl	Resistente. Resistant. Résiste. Erfüllt.
Resistenza al fuoco Reaction to fire Réaction au feu Brandschutz kaasse	UNI EN 13501-1-2009	A richiesta. Available on request. Sur demande. Anforderungenerfüllt.

Tagina S.p.a. si riserva di modificare, senza alcun preavviso, il packaging dei prodotti, le grafiche, i colori e i decori riportati nelle immagini che sono pertanto da ritenersi indicative.

Tagina S.p.a. reserves the right to change the product packaging, the patterns, colours and decorations shown in the pictures without any prior notice. These aspects, therefore should be considered for illustrative purposes only.

Tagina S.p.a. se réserve le droit de modifier, sans préavis, l'emballage des produits, les graphismes, les couleurs et les décors représentés dans les images, fournies à titre indicatif.

Die Tagina S.p.A. behält sich vor, die Verpackung der Produkte, die in den Abbildungen gezeigten Grafiken, Farben und Dekors sowie ohne vorherige Ankündigung zu ändern.

Per le condizioni generali di vendita consultare www.tagina.it
General terms and Sales conditions are available on our website www.tagina.it
Les Conditions général de vente sont disponibles sur le site web www.tagina.it
Allgemeine Verkaufsbedingungen sind auf unsere Website verfügbar: www.tagina.it



Tagina S.p.A.
Via Emilia Ponente, 925
48014 Castel Bolognese (RA) - Italy
Tel. +39 0545 197 7303

tagina.it -  DAFIN GROUP



Follow us