



## index

### 2 A / Z

indice alfabetico / alphabetical index /  
alphabetisches Verzeichnis /  
index alphabétique / índice alfabético /  
алфавитный указатель

### 3 LOOKS

indice per effetto / index by look /  
verzeichnis nach optik /  
índice por efectos / index par effet /  
указатель по эффектам

### 4 SIZES

indice per formati / index of sizes /  
inhaltsübersicht formate /  
index des formats / índice de formatos /  
перечень форматов

### 6 SURFACES

indice per superficie / index of surfaces /  
verzeichnis oberfläche /  
index finitions / índice de superficies /  
указатель поверхностей

## premium

### 8 INTRODUCTION

introduzione / introduction / einleitung /  
introduction / introducción / введение

### 18 CLEANOUT

protezione antibatterica / antibacterial  
protection / antibakterieller Schutz / protection  
antibactérienne / protección antibacteriana /  
антибактериальная защита

### 44 STORIE

cultura e ispirazione / culture and inspiration /  
Kultur und Inspiration / culture et inspiration /  
cultura e inspiración / культура и вдохновение

### 88 MARBLE EFFECT

gres effetto marmo / marble effect porcelain  
stoneware / Feinsteinzeug in Marmor-Optik /  
grès cérame effet marbre / gres porcelánico  
efecto mármol / керамогранит с эффектом  
мрамор

### 132 STONE EFFECT

gres effetto pietra / stone effect stoneware /  
Feinsteinzeug in Natursteinoptik /  
grès effet pierre / gres efecto piedra /  
керамогранит под камень

### 200 CONCRETE EFFECT

gres effetto cemento / concrete effect  
stoneware / Beton-Cotto-Optik Feinsteinzeug /  
grès effet ciment cotto / gres efecto cotto  
cemento / керамогранит с эффектом  
неглазурованной керамики-цемента

### 280 WOOD EFFECT

gres effetto legno / wood effect stoneware /  
Holzoptik Feinsteinzeug / grès effet bois /  
gres de efecto madera / керамогранит  
с эффектом дерева

### 388 XT20

extra spessore 20 mm / extra thickness 20 mm /  
Überstärke 20 mm / épaisseur extra 20 mm /  
grosor extra de 20 mm / увеличенная толщина

### 472 WALL TILES

rivestimenti / wandfliesen / revêtements  
de mur / revestimientos / настенная плитка

## smart

### 588 SMART FLOOR

gres porcellanato / porcelain stoneware /  
feinsteinzeug / grès cérame / gres porcelánico /  
керамогранит

### 630 SMART WALL

rivestimenti / wall tiles / wandfliesen / revêtements  
de mur / revestimientos / настенная плитка

## tech info

### 680 APPENDIX

appendice / appendix / anhang / appendice /  
apêndice / приложение

# A / Z

- 74 A\_Mano
- 68 Abitare
- 116 Bistrot
- 504 Bistrot Wall Slim 6/8 mm
- 240 Boom
- 578 Brick Glossy
- 270 Calce
- 632 Candy
- 598 Casablanca
- 660 Casablanca Wall
- 482 Cocciopesto Slim 6/8 mm
- 252 Concept
- 468 Concept XT20
- 62 Contrasti
- 664 Craft
- 590 Creek
- 636 Creek Wall
- 274 Eden
- 618 Emilia
- 668 Energy
- 264 Epoca
- 610 Escape
- 20 Eterna
- 26 Eterna Wall
- 574 Fantasy Slim 6/8 mm
- 672 Feel
- 544 Flex
- 550 Frame
- 556 Freestyle
- 614 Freetime
- 622 Galassia
- 46 Gleeze
- 644 Grace
- 338 Harmony
- 126 Imperiale
- 524 Imperiale Wall
- 90 Incanto 6 mm
- 218 Ironstone 6 mm
- 648 Land
- 58 Look
- 202 Maiora Concrete 6 mm
- 106 Maiora Marble 6 mm
- 52 Mélange
- 540 Off
- 80 Ottocento
- 232 Patina
- 460 Patina XT20
- 226 Re\_Solution
- 134 Realstone\_Argent 6 mm
- 166 Realstone\_Cardoso
- 414 Realstone\_Cardoso XT20
- 170 Realstone\_Jerusalem
- 418 Realstone\_Jerusalem XT20
- 138 Realstone\_Lunar
- 390 Realstone\_Lunar XT20
- 144 Realstone\_Navigli
- 396 Realstone\_Navigli XT20
- 148 Realstone\_PietrAntica
- 400 Realstone\_PietrAntica XT20
- 176 Realstone\_Quarzite
- 422 Realstone\_Quarzite XT20
- 160 Realstone\_Rain
- 410 Realstone\_Rain XT20
- 154 Realstone\_Slate
- 406 Realstone\_Slate XT20
- 594 Replace
- 652 Replace Wall
- 474 Resina Slim 6/8 mm
- 246 Rewind
- 560 Rewind Wall
- 464 Rewind XT20
- 510 Ritual Slim 6/8 mm
- 32 Roots
- 38 Roots Wall
- 602 Season
- 606 Sound
- 182 Stoneway\_Ardesia
- 426 Stoneway\_Ardesia XT20

- 188 Stoneway\_Barge Antica
- 430 Stoneway\_Barge Antica XT20
- 194 Stoneway\_Porfido
- 434 Stoneway\_Porfido XT20
- 210 Stratford 6 mm
- 454 Stratford XT20
- 258 Studio
- 490 Tactile Slim 6/8 mm
- 532 Tempera
- 498 Terracruda Slim 6/8 mm
- 516 TexCem Slim 6/8 mm
- 584 Touch
- 566 Trama
- 626 Unitech
- 676 Unitech Wall
- 382 Woodchoice
- 354 Woodclass
- 316 Woodclassic
- 344 Woodcomfort
- 366 Woodcraft
- 372 Woodessence
- 378 Woodglam
- 350 Woodlike
- 286 Woodliving
- 442 Woodliving XT20
- 298 Woodmania
- 450 Woodmania XT20
- 360 Woodpassion
- 310 Woodplace
- 322 Woodreal
- 282 Woodsense
- 438 Woodsense XT20
- 328 Woodshape
- 304 Woodsoft
- 332 Woodstory
- 292 Woodtale
- 446 Woodtale XT20

# LOOKS

- CLEANOUT**
- 20 Eterna
- 26 Eterna Wall
- 32 Roots
- 38 Roots Wall
- STORIE**
- 46 Gleeze
- 52 Mélange
- 58 Look
- 62 Contrasti
- 68 Abitare
- 74 A\_Mano
- 80 Ottocento
- MARBLE EFFECT**
- 90 Incanto 6 mm
- 106 Maiora Marble 6 mm
- 116 Bistrot
- 126 Imperiale
- Wall tiles
- 504 Bistrot Wall Slim 6/8 mm
- 524 Imperiale Wall
- STONE EFFECT**
- 134 Realstone\_Argent 6 mm
- 138 Realstone\_Lunar
- 144 Realstone\_Navigli
- 148 Realstone\_PietrAntica
- 154 Realstone\_Slate
- 160 Realstone\_Rain
- 166 Realstone\_Cardoso
- 170 Realstone\_Jerusalem
- 176 Realstone\_Quarzite
- 182 Stoneway\_Ardesia
- 188 Stoneway\_Barge Antica
- 194 Stoneway\_Porfido
- CONCRETE EFFECT**
- 202 Maiora Concrete 6 mm
- 210 Stratford 6 mm
- 218 Ironstone 6 mm
- 226 Re\_Solution
- 232 Patina
- 240 Boom
- 246 Rewind
- 252 Concept
- 258 Studio
- 264 Epoca
- 270 Calce
- 274 Eden
- Wall tiles
- 474 Resina Slim 6/8 mm
- 482 Cocciopesto Slim 6/8 mm
- 490 Tactile Slim 6/8 mm
- 498 Terracruda Slim 6/8 mm
- 510 Ritual Slim 6/8 mm

- 516 TexCem Slim 6/8 mm
- 544 Flex
- 560 Rewind Wall
- WOOD EFFECT**
- 282 Woodsense
- 286 Woodliving
- 292 Woodtale
- 298 Woodmania
- 304 Woodsoft
- 310 Woodplace
- 316 Woodclassic
- 322 Woodreal
- 328 Woodshape
- 332 Woodstory
- 338 Harmony
- 344 Woodcomfort
- 350 Woodlike
- 354 Woodclass
- 360 Woodpassion
- 366 Woodcraft
- 372 Woodessence
- 378 Woodglam
- 382 Woodchoice
- XT20**
- 390 Realstone\_Lunar XT20
- 396 Realstone\_Navigli XT20
- 400 Realstone\_PietrAntica XT20
- 406 Realstone\_Slate XT20
- 410 Realstone\_Rain XT20
- 414 Realstone\_Cardoso XT20
- 418 Realstone\_Jerusalem XT20
- 422 Realstone\_Quarzite XT20
- 426 Stoneway\_Ardesia XT20
- 430 Stoneway\_Barge Antica XT20
- 434 Stoneway\_Porfido XT20
- 438 Woodsense XT20
- 442 Woodliving XT20
- 446 Woodtale XT20
- 450 Woodmania XT20
- 454 Stratford XT20
- 460 Patina XT20
- 464 Rewind XT20
- 468 Concept XT20
- WALL TILES**
- 40x120
- 474 Resina Slim 6/8 mm
- 482 Cocciopesto Slim 6/8 mm
- 490 Tactile Slim 6/8 mm
- 498 Terracruda Slim 6/8 mm
- 504 Bistrot Wall Slim 6/8 mm
- 32,5x97,7
- 510 Ritual Slim 6/8 mm
- 516 TexCem Slim 6/8 mm

- 30x90
- 524 Imperiale Wall
- 532 Tempera
- 540 Off
- 25x76
- 544 Flex
- 550 Frame
- 556 Freestyle
- 560 Rewind Wall
- 566 Trama
- 30x60
- 574 Fantasy Slim 6/8 mm
- 10x30
- 578 Brick Glossy
- 584 Touch
- SMART FLOOR**
- 590 Creek
- 594 Replace
- 598 Casablanca
- 602 Season
- 606 Sound
- 610 Escape
- 614 Freetime
- 618 Emilia
- 622 Galassia
- 626 Unitech
- SMART WALL**
- 25x76
- 636 Creek Wall
- 652 Replace Wall
- 20x50
- 632 Candy
- 636 Creek Wall
- 644 Grace
- 648 Land
- 652 Replace Wall
- 25x38
- 660 Casablanca Wall
- 664 Craft
- 668 Energy
- 672 Feel
- 20x20 / 10x30 / 10x10
- 676 Unitech Wall

# SIZES

**120x278**  
**90** Incanto 6 mm  
**202** Maiora Concrete 6 mm  
**106** Maiora Marble 6 mm

**120x240**  
**202** Maiora Concrete 6 mm  
**106** Maiora Marble 6 mm

**120x120**  
**90** Incanto 6 mm  
**218** Ironstone 6 mm  
**202** Maiora Concrete 6 mm  
**106** Maiora Marble 6 mm  
**232** Patina  
**134** Realstone\_Argent 6 mm  
**138** Realstone\_Lunar  
**160** Realstone\_Rain  
**210** Stratford 6 mm

**75x150**  
**116** Bistrot  
**240** Boom  
**90** Incanto  
**218** Ironstone  
**232** Patina  
**226** Re\_Solution  
**138** Realstone\_Lunar  
**144** Realstone\_Navigli  
**160** Realstone\_Rain  
**154** Realstone\_Slate  
**210** Stratford

**25x150**  
**282** Woodsense

**19x150**  
**282** Woodsense

**60x120**  
**252** Concept  
**590** Creek  
**20** Eterna  
**126** Imperiale  
**90** Incanto 6 mm  
**218** Ironstone 6 mm  
**226** Re\_Solution  
**134** Realstone\_Argent 6 mm  
**166** Realstone\_Cardoso  
**170** Realstone\_Jerusalem  
**138** Realstone\_Lunar  
**396** Realstone\_Navigli XT20  
**148** Realstone\_PietrAntica  
**400** Realstone\_PietrAntica XT20  
**176** Realstone\_Quarzite  
**594** Replace  
**246** Rewind  
**32** Roots

**210** Stratford 6 mm  
**454** Stratford XT20  
**258** Studio

**40x120**  
**504** Bistrot Wall Slim 6/8 mm  
**482** Cocciopesto Slim 6/8 mm  
**474** Resina Slim 6/8 mm  
**490** Tactile Slim 6/8 mm  
**498** Terracruda Slim 6/8 mm  
**442** Woodliving XT20  
**450** Woodmania XT20  
**438** Woodsense XT20  
**446** Woodtale XT20

**30x120**  
**252** Concept  
**286** Woodliving  
**292** Woodtale

**20x120**  
**286** Woodliving  
**298** Woodmania  
**310** Woodplace  
**282** Woodsense  
**304** Woodsoft  
**292** Woodtale

**15x120**  
**286** Woodliving  
**292** Woodtale

**58x116**  
**126** Imperiale

**50x100**  
**414** Realstone\_Cardoso XT20  
**418** Realstone\_Jerusalem XT20  
**390** Realstone\_Lunar XT20  
**422** Realstone\_Quarzite XT20  
**410** Realstone\_Rain XT20  
**406** Realstone\_Slate XT20

**13x100**  
**316** Woodclassic  
**322** Woodreal

**10x100**  
**316** Woodclassic  
**322** Woodreal

**90x90**  
**246** Rewind

**30x90**  
**26** Eterna Wall  
**524** Imperiale Wall  
**540** Off  
**38** Roots Wall  
**532** Tempera

**15x90**  
**338** Harmony  
**344** Woodcomfort  
**350** Woodlike  
**360** Woodpassion  
**328** Woodshape  
**332** Woodstory

**14,5x90**  
**354** Woodclass  
**360** Woodpassion

**80x80**  
**460** Patina XT20  
**396** Realstone\_Navigli XT20  
**406** Realstone\_Slate XT20

**75x75**  
**116** Bistrot  
**240** Boom  
**252** Concept  
**90** Incanto  
**218** Ironstone  
**232** Patina  
**226** Re\_Solution  
**166** Realstone\_Cardoso  
**170** Realstone\_Jerusalem  
**138** Realstone\_Lunar  
**144** Realstone\_Navigli  
**160** Realstone\_Rain  
**154** Realstone\_Slate  
**246** Rewind  
**210** Stratford  
**258** Studio

**37,5x75**  
**252** Concept

**60x60**  
**116** Bistrot  
**240** Boom  
**598** Casablanca  
**252** Concept  
**468** Concept XT20  
**590** Creek  
**20** Eterna  
**126** Imperiale  
**90** Incanto  
**218** Ironstone  
**232** Patina  
**226** Re\_Solution  
**166** Realstone\_Cardoso  
**170** Realstone\_Jerusalem  
**138** Realstone\_Lunar  
**144** Realstone\_Navigli  
**148** Realstone\_PietrAntica  
**176** Realstone\_Quarzite  
**160** Realstone\_Rain

**154** Realstone\_Slate  
**594** Replace  
**246** Rewind  
**464** Rewind XT20  
**32** Roots  
**602** Season  
**606** Sound  
**182** Stoneway\_Ardesia  
**426** Stoneway\_Ardesia XT20  
**188** Stoneway\_Barge Antica  
**430** Stoneway\_Barge Antica XT20  
**434** Stoneway\_Porfido XT20  
**210** Stratford  
**258** Studio  
**438** Woodsense XT20  
**446** Woodtale XT20

**58x58**  
**126** Imperiale

**32,5x97,7**  
**510** Ritual Slim 6/8 mm  
**516** TexCem Slim 6/8 mm

**25x76**  
**636** Creek Wall  
**544** Flex  
**550** Frame  
**556** Freestyle  
**652** Replace Wall  
**560** Rewind Wall  
**566** Trama

**25x38**  
**660** Casablanca Wall  
**664** Craft  
**668** Energy  
**672** Feel

**45x45**  
**598** Casablanca  
**252** Concept  
**590** Creek  
**594** Replace  
**246** Rewind  
**602** Season  
**606** Sound

**30x60**  
**116** Bistrot  
**240** Boom  
**598** Casablanca  
**252** Concept  
**590** Creek  
**20** Eterna  
**574** Fantasy Slim 6/8 mm  
**90** Incanto  
**218** Ironstone  
**232** Patina

**226** Re\_Solution  
**166** Realstone\_Cardoso  
**170** Realstone\_Jerusalem  
**138** Realstone\_Lunar  
**144** Realstone\_Navigli  
**148** Realstone\_PietrAntica  
**176** Realstone\_Quarzite  
**160** Realstone\_Rain  
**154** Realstone\_Slate  
**594** Replace  
**246** Rewind  
**32** Roots  
**602** Season  
**606** Sound  
**182** Stoneway\_Ardesia  
**188** Stoneway\_Barge Antica  
**194** Stoneway\_Porfido  
**210** Stratford  
**258** Studio

**33,3x33,3**  
**598** Casablanca  
**602** Season  
**606** Sound

**30x30**  
**618** Emilia  
**264** Epoca  
**622** Galassia  
**182** Stoneway\_Ardesia  
**194** Stoneway\_Porfido

**21x18,2**  
**116** Bistrot  
**274** Eden  
**246** Rewind  
**210** Stratford

**20x50**  
**632** Candy  
**636** Creek Wall  
**644** Grace  
**648** Land  
**652** Replace Wall

**20x40**  
**182** Stoneway\_Ardesia  
**188** Stoneway\_Barge Antica

**20x20**  
**68** Abitare  
**74** A\_Mano  
**62** Contrasti  
**622** Galassia  
**80** Ottocento  
**182** Stoneway\_Ardesia  
**188** Stoneway\_Barge Antica  
**626** Unitech  
**676** Unitech Wall

**15x60**  
**252** Concept  
**188** Stoneway\_Barge Antica

**15x30**  
**264** Epoca  
**194** Stoneway\_Porfido

**15x15**  
**618** Emilia  
**264** Epoca  
**194** Stoneway\_Porfido

**12,5x50**  
**610** Escape  
**614** Freetime

**11x54**  
**382** Woodchoice

**10x70**  
**366** Woodcraft  
**372** Woodessence  
**378** Woodglam

**10x30**  
**578** Brick Glossy  
**584** Touch  
**626** Unitech  
**676** Unitech Wall

**10x10**  
**252** Concept  
**46** Gleeze  
**52** Mélange  
**626** Unitech  
**676** Unitech Wall

**7x28**  
**270** Calce  
**274** Eden  
**246** Rewind

**7,5x20**  
**46** Gleeze

**6x24**  
**58** Look

**5x15**  
**46** Gleeze

# SURFACES

## IN&OUT

**116** Bistrot  
**240** Boom  
**62** Contrasti  
**590** Creek  
**264** Epoca  
**610** Escape  
**20** Eterna  
**622** Galassia  
**338** Harmony  
**226** Re\_Solution  
**134** Realstone\_Argent 6 mm  
**166** Realstone\_Cardoso  
**170** Realstone\_Jerusalem  
**138** Realstone\_Lunar  
**144** Realstone\_Navigli  
**148** Realstone\_PietrAntica  
**176** Realstone\_Quarzite  
**160** Realstone\_Rain  
**154** Realstone\_Slate  
**594** Replace  
**32** Roots  
**602** Season  
**182** Stoneway\_Ardesia  
**188** Stoneway\_Barge Antica  
**210** Stratford 6 mm  
**258** Studio  
**626** Unitech  
**366** Woodcraft  
**298** Woodmania  
**282** Woodsense  
**328** Woodshape  
**332** Woodstory

## OUTDOOR

**116** Bistrot  
**240** Boom  
**62** Contrasti  
**468** Concept XT20  
**590** Creek  
**264** Epoca  
**610** Escape  
**20** Eterna  
**622** Galassia  
**338** Harmony  
**460** Patina XT20  
**226** Re\_Solution  
**166** Realstone\_Cardoso  
**414** Realstone\_Cardoso XT20  
**170** Realstone\_Jerusalem  
**418** Realstone\_Jerusalem XT20  
**138** Realstone\_Lunar  
**390** Realstone\_Lunar XT20  
**144** Realstone\_Navigli  
**396** Realstone\_Navigli XT20  
**148** Realstone\_PietrAntica  
**400** Realstone\_PietrAntica XT20  
**176** Realstone\_Quarzite  
**422** Realstone\_Quarzite XT20  
**160** Realstone\_Rain  
**410** Realstone\_Rain XT20  
**154** Realstone\_Slate  
**406** Realstone\_Slate XT20  
**594** Replace  
**464** Rewind XT20  
**32** Roots  
**602** Season  
**182** Stoneway\_Ardesia  
**426** Stoneway\_Ardesia XT20  
**188** Stoneway\_Barge Antica  
**430** Stoneway\_Barge Antica XT20  
**194** Stoneway\_Porfido  
**434** Stoneway\_Porfido XT20  
**210** Stratford 6 mm  
**454** Stratford XT20  
**258** Studio  
**626** Unitech  
**366** Woodcraft  
**442** Woodliving XT20  
**298** Woodmania  
**450** Woodmania XT20  
**282** Woodsense  
**438** Woodsense XT20  
**328** Woodshape  
**332** Woodstory  
**446** Woodtale XT20

## GLOSSY

**116** Bistrot  
**578** Brick Glossy  
**632** Candy  
**668** Energy  
**574** Fantasy Slim 6/8 mm  
**550** Frame  
**556** Freestyle  
**46** Gleeze  
**644** Grace  
**58** Look  
**106** Maiora Marble 6 mm  
**52** Mélange  
**126** Imperiale  
**524** Imperiale Wall  
**90** Incanto 6 mm  
**540** Off  
**226** Re\_Solution  
**676** Unitech Wall

# uno stile italiano

design & tradition

**Creatività e design innovativo caratterizzano una ricerca costante mirata ad ottenere la massima qualità del prodotto, attraverso soluzioni ceramiche versatili che fanno di Ragno un testimone autorevole di uno stile italiano inconfondibile, apprezzato in tutto il mondo dal 1949.**

Una gamma completa sempre più specializzata di pavimenti e rivestimenti, formati modulari, decorazioni e pezzi speciali, da utilizzare singolarmente o unire in un armonico mix, per rispondere alle nuove esigenze dell'abitare e del vivere gli spazi commerciali.

## An Italian style

Creativity and innovative design are key to a process of constant renewal that drives to achieve the utmost product quality through versatile ceramic solutions, that make Ragno a fine example of an unmistakable Italian style, popular and respected all over the world since 1949.

A complete, increasingly specialised range of floor and wall coverings, modular sizes, decorations and trims, for use individually or combined in an attractive mix, to respond to the latest demands in home and retail design.

## Italienisches Design

Kreativität und innovatives Design kennzeichnen das beständige Streben nach erstklassiger Produktqualität durch vielseitige keramische Lösungen, die Ragno seit 1949 weltweit zu einem Begriff für unverwechselbares italienisches Design machen.

Eine vollständige und zunehmend spezialisierte Palette an Boden- und Wandbelägen, modularen Formaten, Dekorationen und Formteilen, die einzeln verwendet oder zu einem harmonischen Mix kombiniert werden können, um allen modernen Wohn- und Objektanforderungen gerecht zu werden.

## Un style italien

Créativité et design innovant : les points forts d'une recherche permanente axée sur la qualité maximale du produit, à travers des solutions céramiques polyvalentes qui font de Ragno le témoin incontesté d'un style italien inimitable, apprécié dans le monde entier depuis 1949.

Une gamme complète et toujours plus spécialisée de revêtements de sol et de mur, de formats modulaires, de décorations et de pièces spéciales : à utiliser séparément ou à combiner dans un mélange harmonieux pour répondre aux nouvelles exigences des espaces commerciaux, lieux de vie et d'habitat.

## Un estilo italiano

Creatividad y diseño innovador caracterizan una investigación constante orientada a lograr la máxima calidad del producto a través de soluciones cerámicas versátiles que hacen de Ragno un representante autorizado de un estilo italiano inconfundible, apreciado en el mundo entero desde 1949.

Una gama completa y cada vez más especializada de pavimentos y revestimientos, formatos modulares, decoraciones y piezas especiales, que se utilizan de manera independiente o que combinar en una mezcla armoniosa, para responder a las nuevas exigencias de la vivienda y de los espacios comerciales.

## Итальянский стиль

Творчество и инновационный дизайн - таковы характеристики непрерывных поисков, направленных на получение наивысшего качества продукции. Начиная с 1949 года предлагаемые компанией Ragno универсальные керамические решения наделяют ее статусом авторитетного представителя неподражаемого итальянского стиля, пользующегося успехом во всем мире.

Полная и все более специализированная линейка напольных и облицовочных материалов, модульные форматы, декоры и специальные изделия могут применяться отдельно или сочетаться в гармоничном союзе для удовлетворения новых требований оформления жилья и коммерческих пространств.

# leggerezza e dimensioni extra ordinarie

incanto & maiora

**Incanto e Maiora sono progetti in divenire, collezioni in gres porcellanato a spessore sottile firmate Ragno, pensate per estendere la bellezza e la forza di superfici dall'estetica sorprendente, attraverso soluzioni progettuali e applicazioni innovative per il mondo dell'interior e non solo.**

**Light weight and extraordinary sizes**  
Incanto and Maiora are futuristic projects, Ragno collections of slim-thickness porcelain stoneware slabs, conceived to extend the beauty and impact of surfaces of amazing loveliness, through innovative architectural solutions and applications for the world of interior design and beyond.

**Leichtigkeit und außergewöhnliche Formate**

Incanto und Maiora sind kontinuierliche Projekte, Kollektionen von Ragno aus extraflachen Feinsteinzeug mit Oberflächen von außergewöhnlicher Ästhetik, die innovative Gestaltungsoptionen und Anwendungsmöglichkeiten nicht nur für die Innenarchitektur eröffnen.

**Légèreté et dimensions qui sortent de l'ordinaire**

Deux projets en devenir : Incanto et Maiora, des collections en grès cérame de fine épaisseur signées Ragno, conçues pour exalter la beauté et la force de surfaces à l'esthétique surprenante, à travers des projets et des applications innovantes pour la décoration d'intérieur et au-delà.

**Ligereza y dimensiones extraordinarias**  
Incanto y Maiora son proyectos que evolucionan, colecciones de gres porcelánico de grosor reducido de la marca Ragno, concebidas para ampliar la belleza y la fuerza de unas superficies con una estética sorprendente, a través de soluciones proyectivas y aplicaciones innovadoras que van más allá del mundo del interiorismo.

**Удивительные легкость и размеры**

Incanto и Maiora являются непрерывно развивающимися проектами. Эти коллекции из тонкого керамогранита были созданы компанией Ragno для повышения красоты и выразительности поверхностей с удивительной эстетикой, предлагая инновационные проектные решения и новые сферы применения в дизайне интерьеров и в других областях.



# rivestire con carattere

wall coverings

**Colori, formati, decori, mosaici e strutture 3D si combinano in armonia all'interno di collezioni specifiche per i rivestimenti che trasformano la materia ceramica in complemento d'arredo, capace di dialogare con le tendenze della moda e dell'interior design.**

**Coverings with character**

Colours, sizes, decors, mosaics and 3D structures all combine attractively within covering collections specifically developed to transform ceramics into a furnishing material, able to dialogue with fashion and interior design trends on equal terms.

**Verkleiden mit Charakter**

Farben, Formate, Dekore, Mosaik und 3D-Reliefs stehen in harmonischem Einklang innerhalb von speziell für Wandverkleidungen konzipierten Kollektionen, die die Keramik zu einem Einrichtungselement werden lassen, welches den aktuellen Trends der Mode und des Interior Designs Rechnung trägt.

**Revêtir avec caractère**

Couleurs, formats, décors, mosaïques et structures 3D s'associent en toute harmonie au sein de collections spécifiques pour revêtements muraux, transformant ainsi la matière céramique en accessoire de décoration, en mesure de dialoguer avec les tendances de la mode et de l'architecture d'intérieur.

**Revestir con carácter**

Colores, formatos, decoraciones, mosaicos y estructuras tridimensionales se combinan de modo armonioso en el marco de colecciones específicas de revestimiento que transforman la materia cerámica en un complemento de la decoración capaz de dialogar con las tendencias de la moda y del interiorismo.

**Облицовка стен приобретает характер**

Цвета, форматы, декоры, мозаика и объемные структуры гармонично сочетаются друг с другом в специализированных коллекциях облицовочных материалов, которые превращают керамику в элементы обстановки, вступающие в диалог с тенденциями моды и дизайна интерьеров.





# effetti materici dallo stile unico

mix & match

**Una molteplicità di materie ceramiche costantemente reinterpretate a disposizione di progettisti e privati per favorire l'intercambiabilità di effetti, e suggerire accostamenti esclusivi tra le diverse superfici a catalogo.**

**Material effects with a unique style**

A multiplicity of constantly reinterpreted ceramic materials, at the service of architects and home owners to enable interchangeable effects and suggest exclusive combinations of the various catalogue surfaces.

**Stilvolle Materialoptiken**

Eine vielfältige Produktpalette in ständig neuen keramischen Interpretationen, die Planer und Privatleute zu exklusiven Kombinationen von Materialoptiken in einem Mix und Match aus den im Katalog zur Wahl stehenden Oberflächen anregen.

**Des effets matière au style unique**

Une multitude de matériaux céramiques constamment réinterprétés destinés aux concepteurs et aux particuliers pour favoriser l'interchangeabilité des effets et suggérer des associations exclusives entre les différentes surfaces du catalogue.

**Efectos matéricos de estilo único**

Múltiples materias cerámicas constantemente reinterpretadas a disposición de proyectistas y particulares para favorecer efectos intercambiables y sugerir combinaciones exclusivas entre las diversas superficies propuestas en el catálogo.

**Фактурные эффекты с уникальным стилем**

Многочисленные, постоянно обновляющиеся керамические материалы предоставляются в распоряжение дизайнеров и частных лиц для облегчения взаимосвязи разных эффектов, предлагая уникальные сочетания поверхностей, присутствующих в каталоге.



# in&out senza confini

outdoor

**Soluzioni coordinate tra interno ed esterno donano uniformità visiva e continuità agli spazi. Resistenti e versatili, le superfici StepWise™, strutturate e XT20, sono la proposta Ragno per arredare con stile l'outdoor e viverlo in completa libertà.**

#### Seamless in&out

Matching indoor and outdoor solutions for design schemes with visual uniformity and continuity between spaces. Hard-wearing and versatile, the StepWise™, structured and XT20 surfaces are Ragno's secret for decorating outdoor areas with style and using them in complete freedom.

#### Fließende Übergänge zwischen Innen- und Außenbereich

Abgestimmte Lösungen sorgen für eine einheitliche und durchgängige Optik zwischen Innen- und Außenbereich. Resistent und vielseitig, bietet Ragno mit den Oberflächen StepWise™ – strukturiert und in Version XT20 – die perfekte Lösung für eine stilvolle und ungezwungene Gestaltung des Außenbereichs.

#### Pas de frontières entre intérieur et extérieur

Des solutions coordonnées entre intérieur et extérieur permettent une cohérence visuelle et la continuité des espaces. Dans l'offre de Ragno : résistantes et polyvalentes, les surfaces StepWise™, structurées et XT20, pour un extérieur stylé, à vivre en totale liberté.

#### Interiores y exteriores sin límites

Soluciones coordinadas entre interior y exterior que confieren uniformidad visual y dan continuidad a los espacios. Resistentes y versátiles, las superficies StepWise™, estructuradas y XT20, constituyen la propuesta de Ragno para decorar con estilo el exterior y vivirlo con la máxima libertad.

#### внутренние и наружные пространства без границ

Сочетающиеся решения оформления внутренних и наружных пространств создают зрительную однородность и непрерывность пространств. Прочные и универсальные поверхности StepWise™, фактурные и XT20, являются предложением Ragno для стильного оформления наружных пространств и их свободного использования.



# CLEANOUT



20	Eterna
26	Eterna Wall
32	Roots
38	Roots Wall

CLEANOUT

# Eterna



R8JQ Mix Gris Rettificato 60x120 - 23<sup>5/8</sup>"x47<sup>1/4</sup>" - R8KH Mix Gris Strutturato Rettificato 60x120 - 23<sup>5/8</sup>"x47<sup>1/4</sup>"



## Eterna

gres porcellanato - rettificato monocalibro / porcelain stoneware - rectified monocaliber / feinsteinzeug - rektifiziert / grès cérame émaillé - rectifié monocalibre / gres porcelánico - rectificado monocalibre / керамогранит - ректифицированный монокалиберный

gruppo Bla UNI EN 14411\_G



naturale/ outdoor  
matt



60x120 cm  
23<sup>5/8</sup>"x47<sup>1/4</sup>"  
± 8,5 mm

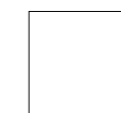

60x60 cm  
23<sup>5/8</sup>"x23<sup>5/8</sup>"  
± 8,5 mm



30x60 cm  
11<sup>13/16</sup>"x23<sup>5/8</sup>"  
± 8,5 mm

# Eterna

60x120 - 23<sup>5/8</sup>"x47<sup>1/4</sup>" 60x60 - 23<sup>5/8</sup>"x23<sup>5/8</sup>" 30x60 - 11<sup>13/16</sup>"x23<sup>5/8</sup>"

## Blanco



**R8JK** 60x120 Rett  
**R8K8** 60x120 Strutt Rett  
**R8JS** 60x60 Rett  
**R8KA** 60x60 Strutt Rett  
**R8JZ** 30x60 Rett  
**R8KR** 30x60 Strutt Rett



## Mix Multicolor



**R8JN** 60x120 Rett  
**R8KF** 60x120 Strutt Rett  
**R8JV** 60x60 Rett  
**R8KM** 60x60 Strutt Rett  
**R8K2** 30x60 Rett  
**R8KU** 30x60 Strutt Rett

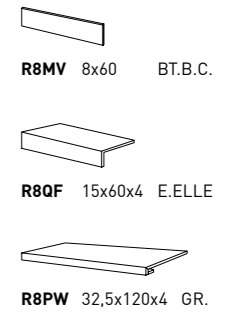

## Arena



**R8JL** 60x120 Rett  
**R8KD** 60x120 Strutt Rett  
**R8JT** 60x60 Rett  
**R8KK** 60x60 Strutt Rett  
**R8KO** 30x60 Rett  
**R8KS** 30x60 Strutt Rett

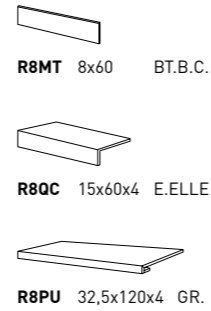

## Mix Beige

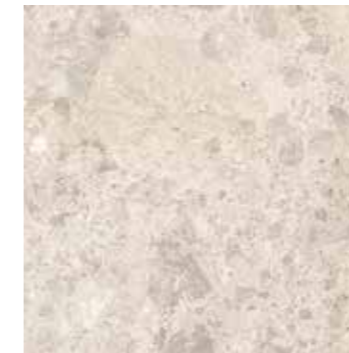

**R8JP** 60x120 Rett  
**R8KG** 60x120 Strutt Rett  
**R8JW** 60x60 Rett  
**R8KN** 60x60 Strutt Rett  
**R8K3** 30x60 Rett  
**R8KV** 30x60 Strutt Rett

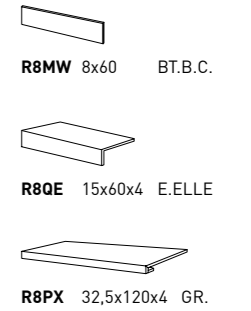

## Greige



**R8JM** 60x120 Rett  
**R8KE** 60x120 Strutt Rett  
**R8JU** 60x60 Rett  
**R8KL** 60x60 Strutt Rett  
**R8K1** 30x60 Rett  
**R8KT** 30x60 Strutt Rett

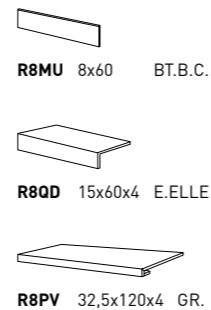

## Mix Gris



**R8JQ** 60x120 Rett  
**R8KH** 60x120 Strutt Rett  
**R8JX** 60x60 Rett  
**R8KP** 60x60 Strutt Rett  
**R8K4** 30x60 Rett  
**R8KW** 30x60 Strutt Rett

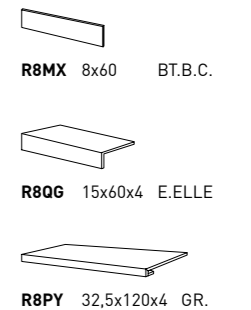

La fuga consigliata per la posa modulare della superficie outdoor nei formati 60x120, 60x60 e 30x60 cm è di 4 mm / The recommended joint for the modular installation of the outdoor surface in the 60x120, 60x60 and 30x60 cm sizes is 4 mm / Nous recommandons un joint de 4 mm pour la pose modulaire de la surface outdoor dans les formats 60x120, 60x60 et 30x60 cm / Für die modulare Verlegung des Außenbelags in den Formaten 60x120, 60x60 und 30x60 cm wird eine Fuge von 4 mm empfohlen / La junta de separación recomendada para la colocación modular en superficies exteriores en los formatos de 60 x 120, 60 x 60 y 30 x 60 cm es de 4 mm / Рекомендованная ширина шва для модульной укладки материалов для наружных пространств в форматах 60x120, 60x60 и 30x60 см равна 4 мм



**R8KG** Mix Beige Strutturato Rettificato 60x120 - 23<sup>5/8</sup>"x47<sup>1/4</sup>" - **R8JP** Mix Beige Rettificato 60x120 - 23<sup>5/8</sup>"x47<sup>1/4</sup>" - **R8JM** Greige Rettificato 60x120 - 23<sup>5/8</sup>"x47<sup>1/4</sup>"

**TECH INFO**

VARIAZIONI CROMATICHE / COLOUR VARIATIONS / FARBVARIATIONEN / VARIATIONS CHROMATIQUES / VARIACIONES CROMÁTICAS / ВАРИАНТЫ ОТТЕНКА



Apprezzabili differenze nell'aspetto di superficie e grafica all'interno della stessa produzione / Clearly distinguishable differences in texture and pattern within the same production run / Auffällige Unterschiede in Aussehen und Struktur innerhalb der gleichen Produktionscharge / Différences visibles au niveau de l'aspect et de la fantaisie entre les carreaux du même lot de production / Diferencias visibles en el aspecto de la superficie y los motivos dentro de un mismo lote de producción / заметные отличия вида поверхности и графики в одной и той же партии

DESTINAZIONE D'USO / INTENDED USE / ANWENDUNGSBEREICH / CHAMP D'APPLICATION / USO PREVISTO / НАЗНАЧЕНИЕ

**G (Arena, Mix Beige: Naturale/Matt Greige, Mix Multicolor, Mix Gris: Naturale/Matt, Strutturato)**

Materiali consigliati per locali sottoposti a sollecitazioni all'abrasione medio pesanti come: case individuali, commerciale leggero / Materials recommended for premises with medium-heavy abrasion levels, such as: detached homes, light-traffic commercial premises / Empfohlen für Räume mit mittelschwerer Abriebbeanspruchung wie: Einfamilienhäuser, leicht beanspruchte Gewerbebereiche / Matériaux recommandés pour des locaux soumis à des contraintes d'abrasion moyennes et fortes comme : maisons particulières, espaces commerciaux soumis à un trafic léger, etc / Materiales recomendados para locales sometidos a esfuerzos de abrasión medio-pesados, como casas unifamiliares y locales comerciales de tráfico ligero / Материалы рекомендованы для использования в частных домах и коммерческих помещениях, подверженных средне-сильному абразивному воздействию

**H (Blanco: Naturale/Matt, Strutturato Arena, Mix Beige: Strutturato)**

Materiali consigliati per sollecitazioni all'abrasione relativamente forti in ambienti anche non protetti da agenti graffianti / Materials recommended for relatively heavy abrasion levels, also in premises not protected against abrasive substances / Materials recommended for relatively heavy abrasion levels, also in premises not protected against abrasive substances / Empfohlen für starke Abriebbeanspruchungen in Bereichen auch ohne Kratzschutzbehandlung / Matériaux recommandés pour des locaux soumis à des fortes contraintes d'abrasion, même non protégés contre les agents abrasifs / Materiales recomendados para soportar esfuerzos de abrasión relativamente intensos incluso en espacios no protegidos frente a agentes abrasivos / Материалы рекомендованы для относительно сильного абразивного воздействия, в том числе в помещениях, не защищенных от царапающих элементов

PEZZI SPECIALI / TRIMS / SPEZIALTEILE / PIÈCES SPÉCIALES / PIEZAS ESPECIALES / СПЕЦИАЛЬНЫЕ ИЗДЕЛИЯ

**BT.B.C.**

Battiscopa Becco Civetta ottenuto per pressatura / Press-formed Coved Edge Skirting Tile / Sockelleiste, Halbrundstab, gepresst / Plinthe bord rond obtenue par pressage / Rodapié canto romo conseguido mediante prensado / Плинтус с закругленным краем, полученный прессованием

**E.Elle (Strutturato)**

Elemento ad Elle tagliato ed assemblato / Two-piece L-Tile / Schenkelplatte, geschnitten und zusammengesetzt / Élément en L coupé et assemblé / Elemento en forma de "L" cortado y montado / Г-образный элемент, состоящий из двух частей

**GR.**

Gradone lineare tagliato ed assemblato / Two-piece straight step / stufenplatte gerade geschnitten und zusammengesetzt / Large marche droite coupée et assemblée / Escalón lineal cortado y montado / Собранный загибающаяся линейная ступень со срезом

TECNOLOGIE / TECHNOLOGIES / TECHNOLOGIEN / TECHNOLOGIES / TECNOLOGÍAS / ТЕХНОЛОГИИ

**StepWise**

Le piastrelle realizzate con questa nuova tecnologia sono caratterizzate da un'elevata resistenza allo scivolamento e da una superficie morbida al tatto e facile da pulire, data l'assenza di ruvidità superficiale / The tiles produced using this new technology have a high degree of slip resistance and a surface which is soft to the touch and easy to clean, since it has no superficial roughness / Les carreaux utilisant cette nouvelle technologie de production se distinguent par une très grande résistance à la glissance et par une surface douce au toucher et facile à nettoyer puisqu'elle ne présente aucune rugosité / Mit dieser neuen Technologie hergestellte Fliesen zeichnen sich durch eine hohe Rutschhemmung, eine weiche Haptik und eine einfache Reinigung aufgrund der fehlenden Oberflächenrauheit aus / Los azulejos fabricados aplicando esta nueva tecnología se caracterizan por su elevada resistencia al deslizamiento y por presentar una superficie suave al tacto y fácil de limpiar, dada la nula aspereza de su superficie / Произведенная по этой новой технологии плитка обладает высокой стойкостью к скольжению и мягкой на ощупь, легко очищаемой поверхностью, что обеспечивается отсутствием шероховатости на поверхности

CARATTERISTICHE / CHARACTERISTICS / EIGENSCHAFTEN / CARACTERISTIQUES / DATOS / ХАРАКТЕРИСТИКИ

	<b>R10</b> Naturale/Matt <b>R11</b> Strutturato	<b>PENDULUM</b> classe 2 Naturale/Matt classe 3 Strutturato plv > 36 Nat, Strutt	<b>D-COF</b> > 0,42	<b>BCR</b> μ > 0,40
	<b>B</b> Naturale/Matt <b>C</b> Strutturato			
	≤ 175 mm <sup>3</sup>			

CERTIFICAZIONI / CERTIFICATIONS / ZERTIFIZIERUNGEN / CERTIFICACIONES / СЕРТИФИКАЦИИ



IMBALLI / PACKAGING / VERPACKUNGEN / EMBALLAGES / EMBALAJES / УПАКОВКИ

		scatole / box / karton / boîte / caja / короб			pallet / pallet / palette / palette / pallet / поддон			
		□	M <sup>2</sup>	KG	□	M <sup>2</sup>	KG	± mm
60x120	Rettificato	2	1,44	31,45	36	51,84	1132,12	8,5
60x60	Rettificato	3	1,08	20,28	40	43,20	811,27	8,5
30x60	Rettificato	6	1,08	20,00	48	51,84	960,00	8,5
8x60	BT.B.C.	21		12,60 ml				8,5
15x60x4	E.ELLE	4		0,36 ml				
32,5x120x4	GR.	2		0,78 ml				

CLEANOUT

# Eterna Wall



R8JN Mix Multicolor Rettificato 60x120 - 23<sup>9/16</sup> x 47<sup>1/4</sup> - R8HY Blanco Rettificato 30x90 - 11<sup>13/16</sup> x 35<sup>7/16</sup>



## Eterna Wall

rivestimenti in pasta bianca - rettificato / white bodywall tiles - rectified / wandfliesen aus weissen ton scherben - rektifiziert / revetements en pate blanche - rectifié / revestimientos en pasta blanca - rectificado / облицовка из белой глины - ректифицировабный

gruppo BIII UNI EN 14411\_L



naturale/  
matt

**CLEAN  
OUT** ANTIBACTERIAL  
PROTECTION

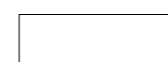

30x90 cm

11<sup>13/16</sup> x 35<sup>7/16</sup>

± 10 mm

# Eterna Wall

30x90 - 11<sup>13/16</sup>"x35<sup>7/16</sup>" 30x30 - 11<sup>13/16</sup>"x11<sup>13/16</sup>"

## Blanco

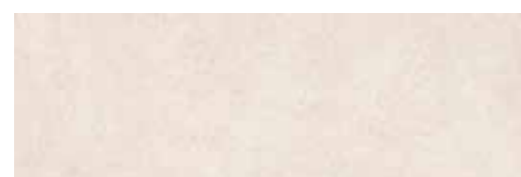

R8HY 30x90 Rett



R8KY 30x30 Mosaico



R8HU 30x90 Struttura Quadro 3D Rett

## Greige

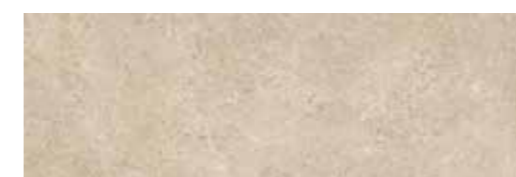

R8JO 30x90 Rett



R8LA 30x30 Mosaico



R8HW 30x90 Struttura Quadro 3D Rett

## Arena

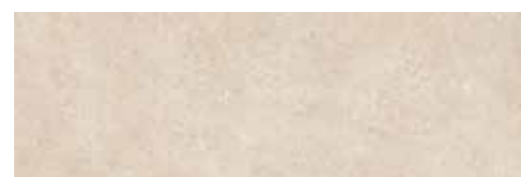

R8HZ 30x90 Rett



R8KZ 30x30 Mosaico



R8HV 30x90 Struttura Quadro 3D Rett

## Decors



R8J2 30x90 Decoro History 3D

Abbinabile ai colori / Matching with colours / Mit den Grundfliesen kombinierbar / Peut s'associer aux carreaux de base de couleurs / Puede combinarse con los fondos / Сочетается с фоновой плиткой



Blanco Arena Greige



# Eterna Wall



R8JW Mix Beige Rettificato 60x60 - 23<sup>9/16</sup>"x23<sup>9/16</sup>" - R8HV Arena Struttura Quadro 3D Rettificato 30x90 - 11<sup>13/16</sup>"x35<sup>7/16</sup>"

## TECH INFO

DECORI / DECORATIVE PIECES / DEKORE / DÉCORS /  
DECORACIONES / ДЕКОРЫ

### Mosaico

Mosaico assemblato su rete in fibra di vetro / Mosaic mesh - mounted  
on fibreglass / Auf Glasfasernetz geklebtes Mosaik / Mosaïque montée  
sur filet en fibre de verre / Mosaico enmallado sobre fibra de vidrio /  
Мозаика, собранная на сетке из стекловолокна

## IMBALLI / PACKAGING / VERPACKUNGEN / EMBALLAGES / EMBALAJES / УПАКОВКИ

		scatole / box / karton / boîte / caja / коробк			pallet / pallet / palette / palette / pallet / поддон			
		□	M²	KG	□	M²	KG	± mm
30x90	Rettificato	5	1,35	21,21	40	54,00	848,52	10
30x90	Struttura Quadro 3D	5	1,35	21,21	40	54,00	848,52	10
30x90	Decoro History 3D	5	1,35	20,83	40	54,00	833,33	10
30x30	Mosaico	4	0,36	6,40	60	21,60	384,00	10

CLEANOUT

# Roots



**R8MC** Grey Strutturato Rettificato 60x120 - 23<sup>5/8</sup>"x47<sup>1/4</sup>" - **R8QL** Grey GR. 32,5x120x4 - 12<sup>13/16</sup>"x47<sup>1/4</sup>"x19<sup>1/16</sup>"  
**R8LE** White Rettificato 60x120 - 23<sup>5/8</sup>"x47<sup>1/4</sup>" - **R8JA** White Rettificato 30x90 - 11<sup>13/16</sup>"x35<sup>7/16</sup>"



## Roots

gres porcellanato - rettificato monocalibro / porcelain stoneware - rectified monocaliber / feinsteinzeug - rektifiziert / grès cérame émaillé - rectifié monocalibre / gres porcelánico - rectificado monocalibre / керамогранит - ректифицированный монокалиберный

gruppo Bla UNI EN 14411\_G



naturale/ outdoor  
matt



**60x120 cm**  
23<sup>5/8</sup>"x47<sup>1/4</sup>"  
± 8,5mm

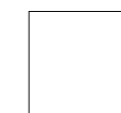

**60x60 cm**  
23<sup>5/8</sup>"x23<sup>5/8</sup>"  
± 8,5mm



**30x60 cm**  
11<sup>13/16</sup>"x23<sup>5/8</sup>"  
± 8,5mm

# Roots

60x120 - 23<sup>5/8</sup>"x47<sup>1/4</sup>" 60x60 - 23<sup>5/8</sup>"x23<sup>5/8</sup>" 30x60 - 11<sup>13/16</sup>"x23<sup>5/8</sup>"

## White



- R8LE** 60x120 Rett
- R8MA** 60x120 Strutt Rett
- R8LK** 60x60 Rett
- R8MG** 60x60 Strutt Rett
- R8LQ** 30x60 Rett
- R8MM** 30x60 Strutt Rett



**R8QU** 8x60 BT.B.C.



**R8QP** 15x60x4 E.ELLE



**R8QJ** 32,5x120x4 GR.

## Multicolor



- R8LH** 60x120 Rett
- R8ME** 60x120 Strutt Rett
- R8LN** 60x60 Rett
- R8MK** 60x60 Strutt Rett
- R8LT** 30x60 Rett
- R8MQ** 30x60 Strutt Rett



**R8QX** 8x60 BT.B.C.



**R8QS** 15x60x4 E.ELLE



**R8QM** 32,5x120x4 GR.

## Beige



- R8LG** 60x120 Rett
- R8MD** 60x120 Strutt Rett
- R8LM** 60x60 Rett
- R8MJ** 60x60 Strutt Rett
- R8LS** 30x60 Rett
- R8MP** 30x60 Strutt Rett



**R8QV** 8x60 BT.B.C.



**R8QQ** 15x60x4 E.ELLE



**R8QK** 32,5x120x4 GR.

## Grey



- R8LF** 60x120 Rett
- R8MC** 60x120 Strutt Rett
- R8LL** 60x60 Rett
- R8MH** 60x60 Strutt Rett
- R8LR** 30x60 Rett
- R8MN** 30x60 Strutt Rett



**R8QW** 8x60 BT.B.C.

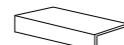

**R8QR** 15x60x4 E.ELLE



**R8QL** 32,5x120x4 GR.

La fuga consigliata per la posa modulare della superficie outdoor nei formati 60x120, 60x60 e 30x60 cm è di 4 mm / The recommended joint for the modular installation of the outdoor surface in the 60x120, 60x60 and 30x60 cm sizes is 4 mm / Nous recommandons un joint de 4 mm pour la pose modulaire de la surface outdoor dans les formats 60x120, 60x60 et 30x60 cm / Für die modulare Verlegung des Außenbelags in den Formaten 60x120, 60x60 und 30x60 cm wird eine Fuge von 4 mm empfohlen / La junta de separación recomendada para la colocación modular en superficies exteriores en los formatos de 60 x 120, 60 x 60 y 30 x 60 cm es de 4 mm / Рекомендованная ширина шва для модульной укладки материалов для наружных пространств в форматах 60x120, 60x60 и 30x60 см равна 4 мм

# Roots



R8MD Beige Strutturato Rettificato 60x120 - 23<sup>5/8</sup>"x47<sup>1/4</sup>"

## TECH INFO

VARIAZIONI CROMATICHE / COLOUR VARIATIONS / FARBVARIATIONEN / VARIATIONS CHROMATIQUES / VARIACIONES CROMÁTICAS / ВАРИАНТЫ ОТТЕНКА

### V2 (White, Beige, Grey)

Apprezzabili differenze nell'aspetto di superficie e grafica all'interno della stessa produzione / Clearly distinguishable differences in texture and pattern within the same production run / Auffällige Unterschiede in Aussehen und Struktur innerhalb der gleichen Produktionscharge / Différences visibles au niveau de l'aspect et de la fantaisie entre les carreaux du même lot de production / Diferencias visibles en el aspecto de la superficie y los motivos dentro de un mismo lote de producción / заметные отличия вида поверхности и графики в одной и той же партии

### V3 (Multicolor)

Significativa variazione di aspetto superficiale, grafica e colore da piastrella a piastrella e all'interno della stessa piastrella. Si consiglia di visionare la gamma cromatica prima della selezione del materiale / Significant variation in texture, pattern and colour from tile to tile within the same production run. The colour range should be viewed before selecting the material / Bedeutende Variation in Aussehen, Struktur und Farbe von Fliese zu Fliese und in ein und derselben Fliese. Es wird empfohlen, das Farbsortiment vor der Auswahl des Materials zu prüfen / Variation significative au niveau de l'aspect, de la fantaisie et de la couleur entre les carreaux et au sein d'un même carreau. Il est recommandé de consulter la gamme des couleurs avant de sélectionner le matériel / Variación considerable en el aspecto superficial, los motivos y el color entre un azulejo y otro y dentro del propio azulejo. Es aconsejable visualizar la gama cromática antes de seleccionar el material / Значительные отличия вида поверхности, графики и цвета у разных плиток и на одной и той же плитке. Перед отбором материала рекомендуется посмотреть цветовую гамму

DESTINAZIONE D'USO / INTENDED USE / ANWENDUNGSBEREICH / CHAMP D'APPLICATION / USO PREVISTO / НАЗНАЧЕНИЕ

### G (Naturale/Matt, Strutturato)

Materiali consigliati per locali sottoposti a sollecitazioni all'abrasione medio pesanti come: case individuali, commerciale leggero / Materials recommended for premises with medium-heavy abrasion levels, such as: detached homes, light-traffic commercial premises / Empfohlen für Räume mit mittelschwerer Abriebbeanspruchung wie: Einfamilienhäuser, leicht beanspruchte Gewerbebereiche / Matériaux recommandés pour des locaux soumis à des contraintes d'abrasion moyennes et fortes comme : maisons particulières, espaces commerciaux soumis à un trafic léger, etc / Materiales recomendados para locales sometidos a esfuerzos de abrasión medio-pesados, como casas unifamiliares y locales comerciales de tráfico ligero / Материалы рекомендованы для использования в частных домах и коммерческих помещениях, подверженных средне-сильному абразивному воздействию

CARATTERISTICHE / CHARACTERISTICS / EIGENSCHAFTEN / CARACTERISTIQUES / DATOS / ХАРАКТЕРИСТИКИ

	<b>R10</b> Naturale/Matt <b>R11</b> Strutturato	<b>PENDULUM</b> classe 2 Naturale/Matt classe 3 Strutturato ptv > 36 Nat, Strutt	<b>D-COF</b> > 0,42	<b>BCR</b> μ > 0,40
--	--	---	------------------------	------------------------

**B** Naturale/Matt  
**C** Strutturato

≤ 175 mm<sup>2</sup>

PEZZI SPECIALI / TRIMS / SPEZIALTEILE / PIÈCES SPÉCIALES / PIEZAS ESPECIALES / СПЕЦИАЛЬНЫЕ ИЗДЕЛИЯ

### BT.B.C.

Battiscopa Becco Civetta ottenuto per pressatura / Press-formed Coved Edge Skirting Tile / Sockelleiste, Halbrundstab, gepresst / Plinthe bord rond obtenue par pressage / Rodapié canto romo conseguido mediante prensado / Плинтус с закругленным краем, полученный прессованием

### E.Elle (Strutturato)

Elemento ad Elle tagliato ed assemblato / Two-piece L-Tile / Schenkelplatte, geschnitten und zusammengesetzt / Élément en L coupé et assemblé / Elemento en forma de "L" cortado y montado / Г-образный элемент, состоящий из двух частей

### GR.

Gradone lineare tagliato ed assemblato / Two-piece straight step / stufenplatte gerade geschnitten und zusammengesetzt / Large marche droite coupée et assemblée / Escalón lineal cortado y montado / Собранный загибающаяся линейная ступень со срезом

TECNOLOGIE / TECHNOLOGIES / TECHNOLOGIEN / TECHNOLOGIES / TECNOLOGÍAS / ТЕХНОЛОГИИ

### StepWise

Le piastrelle realizzate con questa nuova tecnologia sono caratterizzate da un'elevata resistenza allo scivolamento e da una superficie morbida al tatto e facile da pulire, data l'assenza di ruvidità superficiale / The tiles produced using this new technology have a high degree of slip resistance and a surface which is soft to the touch and easy to clean, since it has no superficial roughness / Les carreaux utilisant cette nouvelle technologie de production se distinguent par une très grande résistance à la glissance et par une surface douce au toucher et facile à nettoyer puisqu'elle ne présente aucune rugosité / Mit dieser neuen Technologie hergestellte Fliesen zeichnen sich durch eine hohe Rutschhemmung, eine weiche Haptik und eine einfache Reinigung aufgrund der fehlenden Oberflächenrauheit aus / Los azulejos fabricados aplicando esta nueva tecnología se caracterizan por su elevada resistencia al deslizamiento y por presentar una superficie suave al tacto y fácil de limpiar, dada la nula aspereza de su superficie / Произведенная по этой новой технологии плитка обладает высокой стойкостью к скольжению и мягкой на ощупь, легко очищаемой поверхностью, что обеспечивается отсутствием шероховатости на поверхности

CERTIFICAZIONI / CERTIFICATIONS / ZERTIFIZIERUNGEN / CERTIFICACIONES / СЕРТИФИКАЦИИ



IMBALLI / PACKAGING / VERPACKUNGEN / EMBALLAGES / EMBALAJES / УПАКОВКИ

		scatole / box / karton / boîte / caja / коробк			pallet / pallet / palette / palette / pallet / поддон			
		□	M <sup>2</sup>	KG	□	M <sup>2</sup>	KG	± mm
60x120	Rettificato	2	1,44	27,99	36	51,84	1007,98	8,5
60x60	Rettificato	3	1,08	20,71	40	43,20	828,54	8,5
30x60	Rettificato	6	1,08	20,52	48	51,84	985,36	8,5
8x60	BT.B.C.	21	12,60 ml	20,00				8,5
15x60x4	E.ELLE strutt.	4	0,36 ml	4,94				
32,5x120x4	GR.	2	0,78 ml	17,69				

CLEANOUT

# Roots Wall



R8JH White Struttura District 3D Rettificato 30x90 - 11<sup>13/16</sup>"x35<sup>7/16</sup>" - R8LF Grey Rettificato 60x120 - 23<sup>5/8</sup>"x47<sup>1/4</sup>"



## Roots Wall

rivestimenti in pasta bianca - rettificato / white bodywall tiles - rectified / wandfliesen aus weissen ton scherben - rektifiziert / revetements en pate blanche - rectifié /  
 revestimientos en pasta blanca - rectificado / облицовка из белой глины - ректифицируемый  
 gruppo BIII UNI EN 14411\_L

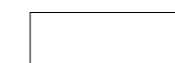

30x90 cm  
 11<sup>13/16</sup>"x35<sup>7/16</sup>"  
 ± 10 mm

# Roots Wall

30x90 - 11<sup>13/16</sup> x 35<sup>7/16</sup> 30x30 - 11<sup>13/16</sup> x 11<sup>13/16</sup>

## White



**R8JA** 30x90 Rett



**R8PP** 30x30 Mosaico



**R8JH** 30x90 Struttura District 3D Rett

## Beige



**R8J9** 30x90 Rett



**R8PQ** 30x30 Mosaico



**R8JF** 30x90 Struttura District 3D Rett

## Grey



**R8JB** 30x90 Rett



**R8PR** 30x30 Mosaico



**R8JG** 30x90 Struttura District 3D Rett

## Decors



**R8JD** 30x90 Decoro Bluwall Grey

Abbinabile ai colori / Matching with colours / Mit den Grundfliesen kombinierbar / Peut s'associer aux carreaux de base de couleurs / Puede combinarse con los fondos / Сочетается с фоновой плиткой:



**White Grey**



**R8PM** 30x90 Decoro Bluwall Beige

Abbinabile ai colori / Matching with colours / Mit den Grundfliesen kombinierbar / Peut s'associer aux carreaux de base de couleurs / Puede combinarse con los fondos / Сочетается с фоновой плиткой:



**White Beige**

# Roots Wall



R8JD Roots Wall Decoro Bluwall Grey Rettificato 30x90 - 11<sup>13/16</sup>"x35<sup>7/16</sup>" - R7FR Woodsense Marrone Rettificato 19x150 - 7<sup>1/2</sup>"x59<sup>1/16</sup>"

## TECH INFO

DECORI / DECORATIVE PIECES / DEKORE / DÉCORS /  
DECORACIONES / ДЕКОРЫ

### Mosaico

Mosaico assemblato su rete in fibra di vetro / Mosaic mesh - mounted  
on fibreglass / Auf Glasfasernetz geklebtes Mosaik / Mosaïque montée  
sur filet en fibre de verre / Mosaico enmallado sobre fibra de vidrio /  
Мозаика, собранная на сетке из стекловолокна

## IMBALLI / PACKAGING / VERPACKUNGEN / EMBALAJES / УПАКОВКИ

		scatole / box / karton / boîte / caja / коробк			pallet / pallet / palette / palette / pallet / поддон			
		□	M²	KG	□	M²	KG	± mm
30x90	Rettificato	5	1,35	21,21	40	54,00	848,52	10
30x90	Struttura District 3D	5	1,35	21,21	40	54,00	848,52	10
30x90	Decoro Bluwall	5	1,35	22,33	40	54,00	893,18	10
30x30	Rettificato	4	0,36	6,40	60	21,60	384,00	10

# STORIE



- 46 Gleeze
- 52 Mélange
- 58 Look
- 62 Contrasti
- 68 Abitare
- 74 A\_Mano
- 80 Ottocento



STORIE

# Gleeze



## Gleeze

gres porcellanato / porcelain stoneware / feinsteinzeug / grès cérame émaillé / gres porcelánico / керамогранит

gruppo Bla UNI EN 14411\_6



glossy



**10x10 cm**

3<sup>15</sup>/<sub>16</sub>" x 3<sup>15</sup>/<sub>16</sub>"

± 10 mm - 12,5 mm



**7,5x20 cm**

2<sup>15</sup>/<sub>16</sub>" x 7<sup>7</sup>/<sub>8</sub>"

± 10 mm - 12,5 mm



**5x15 cm**

1<sup>15</sup>/<sub>16</sub>" x 5<sup>7</sup>/<sub>8</sub>"

± 10 mm

**R8GL** Gleeze Beige 10x10 - 3<sup>15</sup>/<sub>16</sub>" x 3<sup>15</sup>/<sub>16</sub>" - **R8GT** Gleeze Struttura Egg 3D Beige 10x10 - 3<sup>15</sup>/<sub>16</sub>" x 3<sup>15</sup>/<sub>16</sub>" - **R8XA** Stratford White Rettificato 120x120 - 4<sup>7</sup>/<sub>16</sub>" x 4<sup>7</sup>/<sub>16</sub>"

# Gleeze

10x10 - 3<sup>15/16</sup>"x3<sup>15/16</sup>" 7,5x20 - 2<sup>15/16</sup>"x7<sup>7/8</sup>" 5x15 - 1<sup>15/16</sup>"x5<sup>7/8</sup>"

## Bianco



R8GK 10x10



R8GY 7,5x20

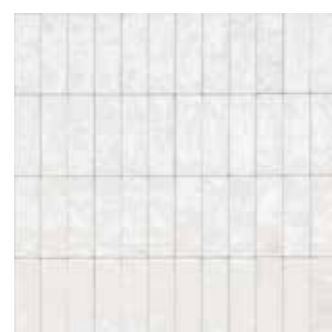

R8HM 5x15



R8GS 10x10 Struttura Egg 3D

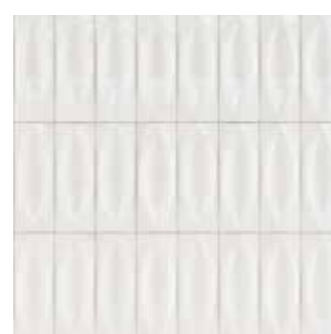

R8HF 7,5x20 Struttura Eye 3D



## Turchese



R8GM 10x10



R8HA 7,5x20



R8HP 5x15



R8GU 10x10 Struttura Egg 3D



R8HH 7,5x20 Struttura Eye 3D



## Beige



R8GL 10x10



R8GZ 7,5x20



R8HN 5x15



R8GT 10x10 Struttura Egg 3D



R8HG 7,5x20 Struttura Eye 3D



## Giada



R8GN 10x10



R8HC 7,5x20



R8HQ 5x15



R8GV 10x10 Struttura Egg 3D



R8HJ 7,5x20 Struttura Eye 3D



Grigio



R8GP 10x10



R8HD 7,5x20



R8HS 5x15

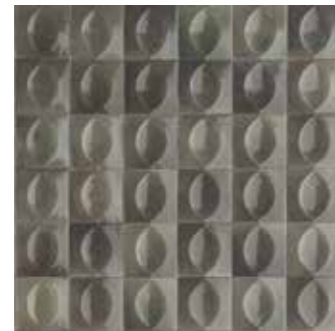

R8GW 10x10 Struttura Egg 3D

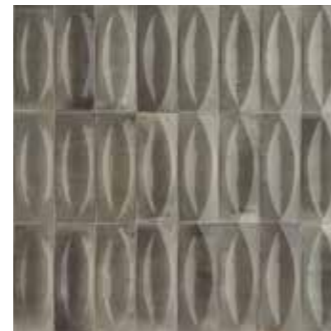

R8HK 7,5x20 Struttura Eye 3D



TECH INFO

VARIAZIONI CROMATICHE / COLOUR VARIATIONS / FARBVARIATIONEN / VARIATIONS CHROMATIQUES / VARIACIONES CROMÁTICAS / ВАРИАНТЫ ОТТЕНКА

V2 (Bianco, Beige)

Apprezzabili differenze nell'aspetto di superficie e grafica all'interno della stessa produzione / Clearly distinguishable differences in texture and pattern within the same production run / Auffällige Unterschiede in Aussehen und Struktur innerhalb der gleichen Produktionscharge / Différences visibles au niveau de l'aspect et de la fantaisie entre les carreaux du même lot de production / Diferencias visibles en el aspecto de la superficie y los motivos dentro de un mismo lote de producción / заметные отличия вида поверхности и графики в одной и той же партии

V3 (Giada, Grigio, Turchese)

Significativa variazione di aspetto superficiale, grafica e colore da piastrella a piastrella e all'interno della stessa piastrella. Si consiglia di visionare la gamma cromatica prima della selezione del materiale / Significant variation in texture, pattern and colour from tile to tile within the same production run. The colour range should be viewed before selecting the material / Bedeutende Variation in Aussehen, Struktur und Farbe von Fliese zu Fliese und in ein und derselben Fliese. Es wird empfohlen, das Farbsortiment vor der Auswahl des Materials zu prüfen / Variation significative au niveau de l'aspect, de la fantaisie et de la couleur entre les carreaux et au sein d'un même carreau. Il est recommandé de consulter la gamme des couleurs avant de sélectionner le matériel / Variación considerable en el aspecto superficial, los motivos y el color entre un azulejo y otro y dentro del propio azulejo. Es aconsejable visualizar la gama cromática antes de seleccionar el material / Значительные отличия вида поверхности, графики и цвета у разных плиток и на одной и той же плитке. Перед отбором материала рекомендуется посмотреть цветовую гамму

DESTINAZIONE D'USO / INTENDED USE / ANWENDUNGSBEREICH / CHAMP D'APPLICATION / USO PREVISTO / НАЗНАЧЕНИЕ

F (Bianco, Beige, Turchese: Glossy)

Materiali consigliati per qualsiasi locale di un'abitazione che non abbia collegamenti diretti con l'esterno o accessi non protetti da zerbini. Medie sollecitazioni all'abrasione / Tiles suitable for any room of a house without direct access from the outside or access not protected by doormats. Mean stress abrasive wear / Für alle Räume des Wohnbereichs empfohlen, zu denen man keinen direkten Zutritt von außen hat oder welche nicht durch Fußteppiche abgegrenzt sind. Mittlere Abriebbeanspruchung / Matériaux conseillés pour toutes les pièces d'une maison qui n'a pas d'accès directs par l'extérieur ou non protégés par des paillasons. Abrasion sous contraintes moyennes / Materiales aconsejados para cualquier habitación de una vivienda sin accesos directos desde el exterior o accesos no protegidos por felpudos. Esfuerzos medianos por abrasión / Материалы рекомендованы для любых жилых помещений, не имеющих прямого выхода на улицу или же доступа без входных ковриков. Среднее абразивное воздействие

E (Giada, Grigio: Glossy)

Materiali consigliati per tutti i locali di un'abitazione, con esclusione dell'ingresso e della cucina; deboli sollecitazioni all'abrasione / Tiles suitable for all rooms of a house except the entrance hall and the kitchen; low stress abrasive wear / Für alle Räume des Wohnbereichs empfohlen, mit Ausschluss von Dielen und Küchen; leichte Abriebbeanspruchung / Carreaux conseillés pour toutes les pièces d'une maison, excepté le vestibule et la cuisine; abrasion sous contraintes faibles / Materiales aconsejados para todas las habitaciones de una vivienda excluyendo el vestíbulo y la cocina; atenuada exposición a la abrasión / Материалы рекомендованы для любых жилых помещений, кроме прихожей и кухни. Небольшое абразивное воздействие

CARATTERISTICHE / CHARACTERISTICS / EIGENSCHAFTEN / CARACTERISTIQUES / DATOS / ХАРАКТЕРИСТИКИ

≤ 175 mm<sup>2</sup>

CERTIFICAZIONI / CERTIFICATIONS / ZERTIFIZIERUNGEN / CERTIFICACIONES / СЕРТИФИКАЦИИ



IMBALLI / PACKAGING / VERPACKUNGEN / EMBALLAGES / EMBALAJES / УПАКОВКИ

		scatole / box / karton / boîte / caja / коробк			pallet / pallet / palette / palette / pallet / поддон			
		□	M <sup>2</sup>	KG	□	M <sup>2</sup>	KG	± mm
10x10		68	0,68	14,35	72	48,96	1032,91	10
10x10	Struttura Egg 3D	56	0,56	13,39	72	40,32	964,36	12,5
7,5x20		50	0,75	16,10	76	57,00	1223,70	10,0
7,5x20	Struttura Eye 3D	48	0,72	17,05	60	43,20	1023,21	12,5
5x15		108	0,81	17,15	64	51,84	1097,38	10,0

STORIE

# Mélange



R8GE Mélange Oltremare 10x10 - 3<sup>15/16</sup>"x3<sup>15/16</sup>" - R7HP Contrasti Tappeto 10 20x20 - 7<sup>7/8</sup>"x7<sup>7/8</sup>"



## Mélange

Monocottura in pasta bianca / Single Firing white body / Einmalbrand aus weissen ton scherben / Monocuisson en pate blanche / Monococción en pasta blanca / Плитка Однократного Обжига из белой глины

gruppo UNI EN 14411 - J BIIa



glossy



10x10 cm

3<sup>15/16</sup>" x 3<sup>15/16</sup>"

± 10 mm

# Mélange

10x10 - 3<sup>1516</sup>x3<sup>1516</sup>

Beige



R8G0 10x10

Acquamarina



R8GD 10x10

Glicine



R8GC 10x10

Bianco



R8FZ 10x10

Kaki

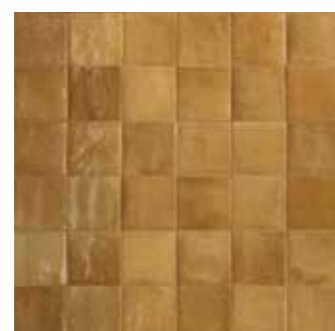

R8G1 10x10

Teal



R8GA 10x10

Nero

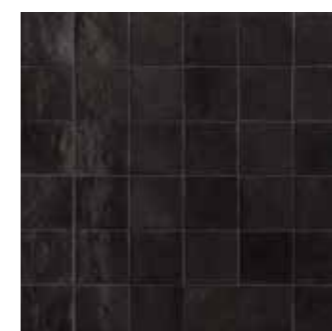

R8GF 10x10

Bordeaux



R8G2 10x10

Oltremare



R8GE 10x10

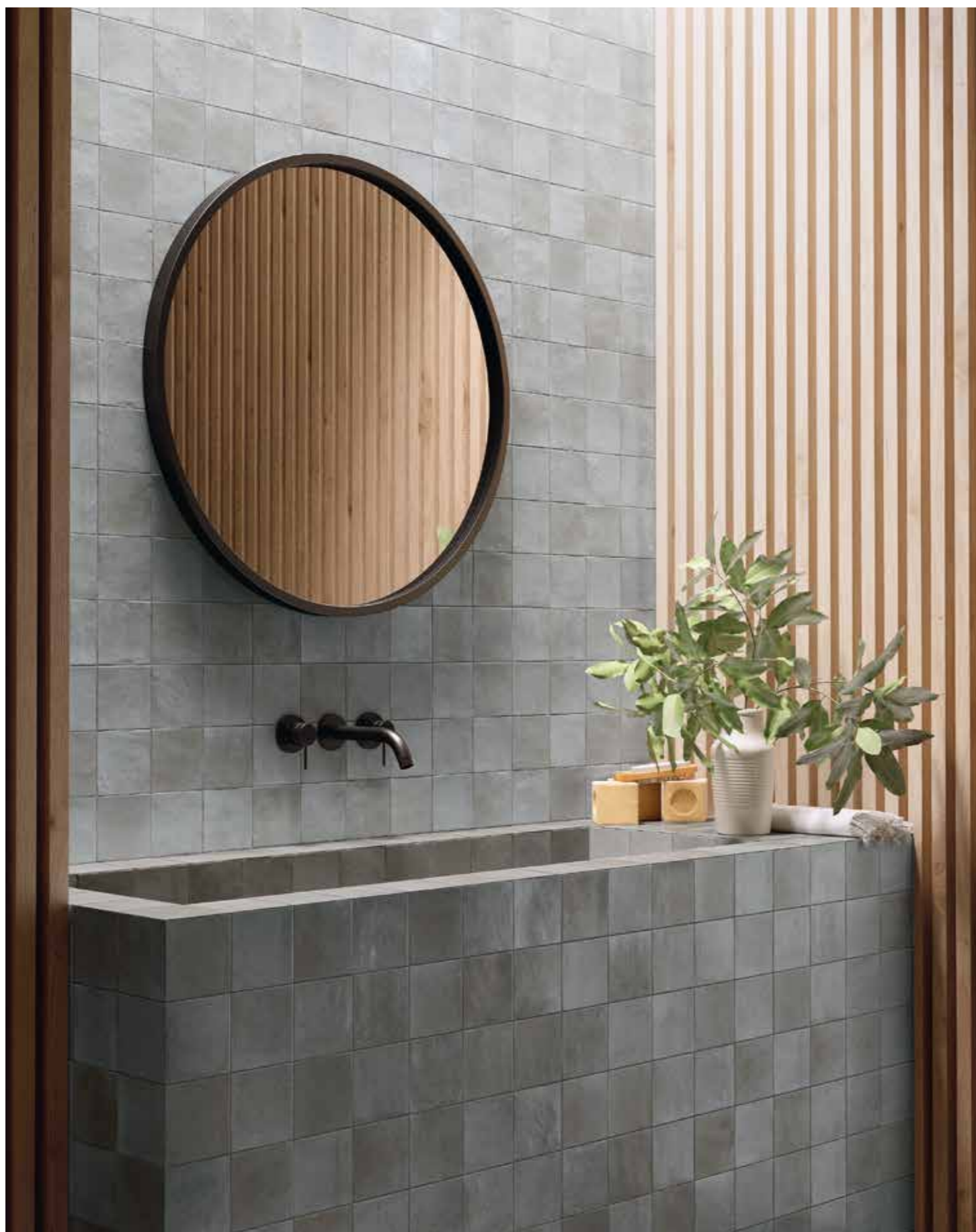

R89C Glicine 10x10 - 3<sup>15/16</sup> x 3<sup>15/16</sup>

TECH INFO

VARIAZIONI CROMATICHE / COLOUR VARIATIONS / FARBVARIATIONEN / VARIATIONS CHROMATIQUES / VARIACIONES CROMÁTICAS / ВАРИАНТЫ ОТТЕККА



Significativa variazione di aspetto superficiale, grafica e colore da piastrella a piastrella e all'interno della stessa piastrella. Si consiglia di visionare la gamma cromatica prima della selezione del materiale / Significant variation in texture, pattern and colour from tile to tile within the same production run. The colour range should be viewed before selecting the material / Bedeutende Variation in Aussehen, Struktur und Farbe von Fliese zu Fliese und in ein und derselben Fliese. Es wird empfohlen, das Farbsortiment vor der Auswahl des Materials zu prüfen / Variation significative au niveau de l'aspect, de la fantaisie et de la couleur entre les carreaux et au sein d'un même carreau. Il est recommandé de consulter la gamme des couleurs avant de sélectionner le matériel / Variación considerable en el aspecto superficial, los motivos y el color entre un azulejo y otro y dentro del propio azulejo. Es aconsejable visualizar la gama cromática antes de seleccionar el material / Значительные отличия вида поверхности, графики и цвета у разных плиток и на одной и той же плитке. Перед отбором материала рекомендуется посмотреть цветовую гамму

IMBALLI / PACKAGING / VERPACKUNGEN / EMBALLAGES / EMBALAJES / УПАКОВКИ

	scatole / box / karton / boîte / caja / короб			pallet / pallet / palette / palette / pallet / поддон			
	□	M²	KG	□	M²	KG	± mm
10x10	54	0,54	10,67	80	43,20	853,76	10

STORIE

# Look



R8FM Look Bianco 6x24 - 23<sup>8</sup>/<sub>16</sub>" x 9<sup>7</sup>/<sub>16</sub>" - R7AQ Realstone\_Lunar Beige Rettificato 75x75 - 29<sup>1</sup>/<sub>2</sub>" x 29<sup>1</sup>/<sub>2</sub>"



## Look

gres porcellanato / porcelain stoneware / feinsteinzeug / grès cérame émaillé / gres porcelánico / керамогранит

gruppo Bla UNI EN 14411\_6



glossy



6x24 cm

23<sup>8</sup>/<sub>16</sub>" x 9<sup>7</sup>/<sub>16</sub>"

± 10 mm

# Look

6x24 - 2<sup>38</sup> x 9<sup>115</sup>

## Bianco



R8FM 6x24

## Nero



R8FN 6x24

## Beige



R8FP 6x24

## Ocra



R8FT 6x24

## Avio

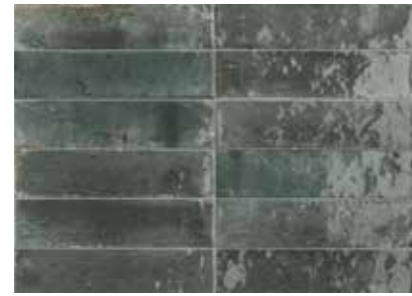

R8FQ 6x24

## Blu



R8FR 6x24

## Oliva



R8FS 6x24

## TECH INFO

VARIAZIONI CROMATICHE / COLOUR VARIATIONS / FARBVARIATIONEN / VARIATIONS CHROMATIQUES / VARIACIONES CROMÁTICAS / ВАРИАНТЫ ОТТЕНКА



V2

Apprezzabili differenze nell'aspetto di superficie e grafica all'interno della stessa produzione / Clearly distinguishable differences in texture and pattern within the same production run / Auffällige Unterschiede in Aussehen und Struktur innerhalb der gleichen Produktionscharge / Différences visibles au niveau de l'aspect et de la fantaisie entre les carreaux du même lot de production / Diferencias visibles en el aspecto de la superficie y los motivos dentro de un mismo lote de producción / заметные отличия вида поверхности и графики в одной и той же партии



V3 (Beige, Oliva, Blu)

Significativa variazione di aspetto superficiale, grafica e colore da piastrella a piastrella e all'interno della stessa piastrella. Si consiglia di visionare la gamma cromatica prima della selezione del materiale / Significant variation in texture, pattern and colour from tile to tile within the same production run. The colour range should be viewed before selecting the material / Bedeutende Variation in Aussehen, Struktur und Farbe von Fliese zu Fliese und in ein und derselben Fliese. Es wird empfohlen, das Farbsortiment vor der Auswahl des Materials zu prüfen / Variation significative au niveau de l'aspect, de la fantaisie et de la couleur entre les carreaux et au sein d'un même carreau. Il est recommandé de consulter la gamme des couleurs avant de sélectionner le matériel / Variación considerable en el aspecto superficial, los motivos y el color entre un azulejo y otro y dentro del propio azulejo. Es aconsejable visualizar la gama cromática antes de seleccionar el material / Значительные отличия вида поверхности, графики и цвета у разных плиток и на одной и той же плитке. Перед отбором материала рекомендуется посмотреть цветовую гамму

DESTINAZIONE D'USO / INTENDED USE / ANWENDUNGSBEREICH / CHAMP D'APPLICATION / USO PREVISTO / НАЗНАЧЕНИЕ

### F: Glossy

Materiali consigliati per qualsiasi locale di un'abitazione che non abbia collegamenti diretti con l'esterno o accessi non protetti da zerbini. Medie sollecitazioni all'abrasione / Tiles suitable for any room of a house without direct access from the outside or access not protected by doormats. Mean stress abrasive wear / Für alle Räume des Wohnbereichs empfohlen, zu denen man keinen direkten Zutritt von außen hat oder welche nicht durch Fußteppiche abgegrenzt sind. Mittlere Abriebbeanspruchung / Matériaux conseillés pour toutes les pièces d'une maison qui n'a pas d'accès directs par l'extérieur ou non protégés par des paillasons. Abrasion sous contraintes moyennes / Materiales aconsejados para cualquier habitación de una vivienda sin accesos directos desde el exterior o accesos no protegidos por felpudos. Esfuerzos medianos por abrasión / Материалы рекомендованы для любых жилых помещений, не имеющих прямого выхода на улицу или же доступа без входных ковриков. Среднее абразивное воздействие

CARATTERISTICHE / CHARACTERISTICS / EIGENSCHAFTEN / CARACTERISTIQUES / DATOS / ХАРАКТЕРИСТИКИ

≤ 175 mm<sup>2</sup>

CERTIFICAZIONI / CERTIFICATIONS / ZERTIFIZIERUNGEN / CERTIFICACIONES / СЕРТИФИКАЦИИ



IMBALLI / PACKAGING / VERPACKUNGEN / EMBALAJES / УПАКОВКИ

	scatole / box / karton / boîte / caja / короб			pallet / pallet / palette / palette / pallet / поддон			
	□	M <sup>2</sup>	KG	□	M <sup>2</sup>	KG	± mm
6x24	36	0,52	10,47	95	49,25	994,71	10



# Contrasti



R7GW Ottanio 20x20 - 776°x776° - R7HQ Tappeto 11 20x20 - 776°x776°



## Contrasti

gres porcellanato / porcelain stoneware / feinsteinzeug / grès cérame émaillé / gres porcelánico / керамогранит  
 gruppo Bla UNI EN 14411\_6



naturale/  
 matt



20x20 cm  
 776°x776°  
 ± 10 mm

# Contrasti

20x20 - 7/16" x 7/16"

## Bianco



R7GQ 20x20

## Grigio

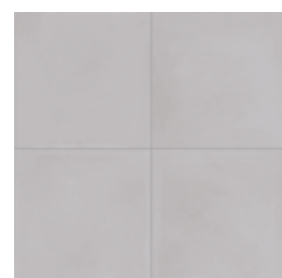

R7GS 20x20



R7HC 20x20 Tappeto 1



R7HD 20x20 Tappeto 2



R7HE 20x20 Tappeto 3

## Antracite

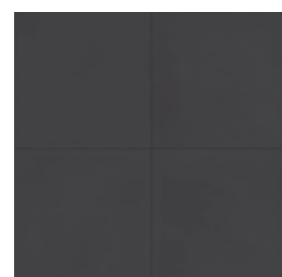

R7HU 20x20



R7HH 20x20 Tappeto 6



R7HJ 20x20 Tappeto 7

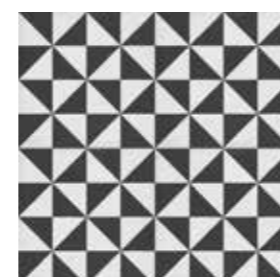

R7HL 20x20 Tappeto 8

## Beige

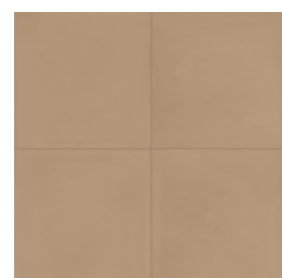

R7GT 20x20



R7HF 20x20 Tappeto 4



R7HG 20x20 Tappeto 5

## Celadon

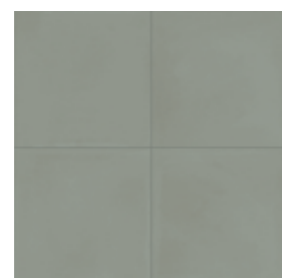

R7GV 20x20



R7HN 20x20 Tappeto 9



R7HP 20x20 Tappeto 10

## Ottanio



R7GW 20x20



R7HQ 20x20 Tappeto 11



R7HR 20x20 Tappeto 12

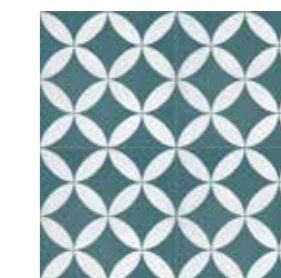

R7HS 20x20 Tappeto 13

## Decors



R7GY 20x20 Decoro Mix Grigio



R7GZ 20x20 Decoro Mix Antracite



R7H4 20x20 Decoro Mix Ottanio

# Contrasti



R7HP Contrasti Tappeto 10 20x20 - 776°x776°

## TECH INFO

VARIAZIONI CROMATICHE / COLOUR VARIATIONS / FARBVARIATIONEN / VARIATIONS CHROMATIQUES / VARIACIONES CROMÁTICAS / ВАРИАНТЫ ОТТЕНКА



Apprezzabili differenze nell'aspetto di superficie e grafica all'interno della stessa produzione / Clearly distinguishable differences in texture and pattern within the same production run / Auffällige Unterschiede in Aussehen und Struktur innerhalb der gleichen Produktionscharge / Différences visibles au niveau de l'aspect et de la fantaisie entre les carreaux du même lot de production / Diferencias visibles en el aspecto de la superficie y los motivos dentro de un mismo lote de producción / заметные отличия вида поверхности и графики в одной и той же партии

DESTINAZIONE D'USO / INTENDED USE / ANWENDUNGSBEREICH / CHAMP D'APPLICATION / USO PREVISTO / НАЗНАЧЕНИЕ

**G (Beige, Grigio, Antracite, Celadon, Ottanio, Tappeto 3, 4, 6, 8, 9, 10, 11, 13: Naturale/Matt)**

Materiali consigliati per locali sottoposti a sollecitazioni all'abrasione medio pesante come: case individuali, commerciale leggero / Materials recommended for premises with medium-heavy abrasion levels, such as: detached homes, light-traffic commercial premises / Empfohlen für Räume mit mittelschwerer Abriebbeanspruchung wie: Einfamilienhäuser, leicht beanspruchte Gewerbebereiche / Matériaux recommandés pour des locaux soumis à des contraintes d'abrasion moyennes et fortes comme : maisons particulières, espaces commerciaux soumis à un trafic léger, etc / Materiales recomendados para locales sometidos a esfuerzos de abrasión medio-pesados, como casas unifamiliares y locales comerciales de tráfico ligero / Материалы рекомендованы для использования в частных домах и коммерческих помещениях, подверженных средне-сильному абразивному воздействию

**H (Bianco, Tappeto 1, 2, 5, 7, 12, Decoro Mix: Naturale/Matt)**

Materiali consigliati per sollecitazioni all'abrasione relativamente forti in ambienti anche non protetti da agenti graffianti / Materials recommended for relatively heavy abrasion levels, also in premises not protected against abrasive substances / Materials recommended for relatively heavy abrasion levels, also in premises not protected against abrasive substances / Empfohlen für starke Abriebbeanspruchungen in Bereichen auch ohne Kratzschutzbehandlung / Matériaux recommandés pour des locaux soumis à des fortes contraintes d'abrasion, même non protégés contre les agents abrasifs / Materiales recomendados para soportar esfuerzos de abrasión relativamente intensos incluso en espacios no protegidos frente a agentes abrasivos / Материалы рекомендованы для относительно сильного абразивного воздействия, в том числе в помещениях, не защищенных от царапающих элементов

DECORI / DECORATIVE PIECES / DEKORE / DÉCORS / DECORACIONES / ДЕКОРЫ

**Decoro Mix**

16 diversi soggetti / 16 different motifs / 16 verschiedene Motive / 16 sujets différents / 16 temas diferentes / 16 различных рисунка

CONSIGLI DI POSA / INSTALLATION ADVICE / HINWEISE ZUR VERLEGUNG / CONSEILS DE POSE / SUGERENCIAS PARA LA COLOCACIÓN / РЕКОМЕНДАЦИИ ПО УКЛАДКЕ

**Tappeto 1,6,7,10,12**

Posa 90° senso orario / 90° clockwise installation / Verband im 90-Grad-Winkel, im Uhrzeigersinn / Pose à 90° dans le sens des aiguilles d'une montre / Colocación 90° sentido de las agujas del reloj / Укладка под 90° по часовой стрелке

TECNOLOGIE / TECHNOLOGIES / TECHNOLOGIEN / TECHNOLOGIES / TECNOLOGÍAS / ТЕХНОЛОГИИ

**StepWise**

Le piastrelle realizzate con questa nuova tecnologia sono caratterizzate da un'elevata resistenza allo scivolamento e da una superficie morbida al tatto e facile da pulire, data l'assenza di ruvidità superficiale / The tiles produced using this new technology have a high degree of slip resistance and a surface which is soft to the touch and easy to clean, since it has no superficial roughness / Les carreaux utilisant cette nouvelle technologie de production se distinguent par une très grande résistance à la glissance et par une surface douce au toucher et facile à nettoyer puisqu'elle ne présente aucune rugosité / Mit dieser neuen Technologie hergestellte Fliesen zeichnen sich durch eine hohe Rutschhemmung, eine weiche Haptik und eine einfache Reinigung aufgrund der fehlenden Oberflächenrauheit aus / Los azulejos fabricados aplicando esta nueva tecnología se caracterizan por su elevada resistencia al deslizamiento y por presentar una superficie suave al tacto y fácil de limpiar, dada la nula aspereza de su superficie / Произведенная по этой новой технологии плитка обладает высокой стойкостью к скольжению и мягкой на ощупь, легко очищающейся поверхностью, что обеспечивается отсутствием шероховатости на поверхности

CARATTERISTICHE / CHARACTERISTICS / EIGENSCHAFTEN / CARACTERISTIQUES / DATOS / ХАРАКТЕРИСТИКИ

	<b>R10</b>	<b>PENDULUM classe 3 ptv &gt; 36</b>	<b>D-COF &gt; 0,42</b>	<b>BCR μ &gt; 0,40</b>
	<b>B</b>			
	<b>≤ 175 mm²</b>			

CERTIFICAZIONI / CERTIFICATIONS / ZERTIFIZIERUNGEN / CERTIFICACIONES / СЕРТИФИКАЦИИ



IMBALLI / PACKAGING / VERPACKUNGEN / EMBALLAGES / EMBALAJES / УПАКОВКИ

		scatole / box / karton / boîte / caja / короб			pallet / pallet / palette / palette / pallet / поддон			
		□	M²	KG	□	M²	KG	± mm
20x20		24	0,96	21,99	54	51,84	1187,90	10
20x20	Tappeto	24	0,96	22,22	54	51,84	1200,00	10
20x20	Decoro Mix	24	0,96	22,22	54	51,84	1200,00	10

# Abitare



R630 Abitare Decoro Tappeto 2 20x20 - 7<sup>16</sup> x 7<sup>16</sup> - R62P Abitare Bianco 20x20 - 7<sup>16</sup> x 7<sup>16</sup>  
 R62T Abitare Fango 20x20 - 7<sup>16</sup> x 7<sup>16</sup> - R5QR Woodstory Bianco 15x90 - 5<sup>76</sup> x 35<sup>716</sup>



## Abitare

gres porcellanato / porcelain stoneware / feinsteinzeug / grès cérame émaillé / gres porcelánico / керамогранит

gruppo Bla UNI EN 14411\_6



naturale/  
matt



20x20 cm  
 7<sup>16</sup> x 7<sup>16</sup>  
 ± 10 mm

# Abitare

20x20 - 7<sup>16</sup>/<sub>16</sub> x 7<sup>16</sup>/<sub>16</sub>

Bianco



R62P 20x20

Azzurro



R62V 20x20

Fango



R62T 20x20

Grigio



R62S 20x20

Arancio



R62U 20x20

Antracite



R62W 20x20

Decors

Azzurro



R62Z 20x20 Tappeto 1

Bianco, Fango, Azzurro



R630 20x20 Tappeto 2

Bianco, Grigio, Antracite



R631 20x20 Tappeto 3

Arancio, Bianco

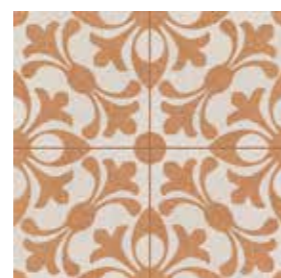

R632 20x20 Tappeto 4

Bianco, Grigio

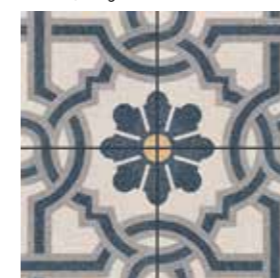

R633 20x20 Tappeto 5

Bianco, Antracite

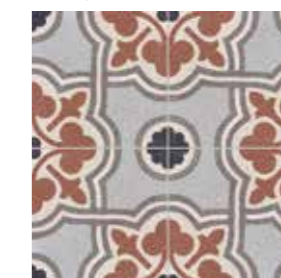

R634 20x20 Tappeto 6

Bianco, Antracite



R635 20x20 Tappeto 7

Bianco, Fango

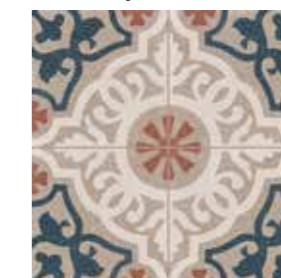

R637 20x20 Tappeto 8



R639 20x20 Abitare Mix



R632 Tappeto 4 20x20 - 7<sup>35</sup> x 7<sup>35</sup>

TECH INFO

VARIAZIONI CROMATICHE / COLOUR VARIATIONS / FARBVARIATIONEN / VARIATIONS CHROMATIQUES / VARIACIONES CROMÁTICAS / ВАРИАНТЫ ОТТЕНКА



Apprezzabili differenze nell'aspetto di superficie e grafica all'interno della stessa produzione / Clearly distinguishable differences in texture and pattern within the same production run / Auffällige Unterschiede in Aussehen und Struktur innerhalb der gleichen Produktionscharge / Différences visibles au niveau de l'aspect et de la fantaisie entre les carreaux du même lot de production / Diferencias visibles en el aspecto de la superficie y los motivos dentro de un mismo lote de producción / заметные отличия вида поверхности и графики в одной и той же партии

DESTINAZIONE D'USO / INTENDED USE / ANWENDUNGSBEREICH / CHAMP D'APPLICATION / USO PREVISTO / НАЗНАЧЕНИЕ

G (Bianco, Azzurro, Grigio, Antracite, Tappeto 1, 2, 5, 7: Naturale/Matt)

Materiali consigliati per locali sottoposti a sollecitazioni all'abrasione medio pesanti come: case individuali, commerciale leggero / Materials recommended for premises with medium-heavy abrasion levels, such as: detached homes, light-traffic commercial premises / Empfohlen für Räume mit mittelschwerer Abriebbeanspruchung wie: Einfamilienhäuser, leicht beanspruchte Gewerbebereiche / Matériaux recommandés pour des locaux soumis à des contraintes d'abrasion moyennes et fortes comme : maisons particulières, espaces commerciaux soumis à un trafic léger, etc / Materiales recomendados para locales sometidos a esfuerzos de abrasión medio-pesados, como casas unifamiliares y locales comerciales de tráfico ligero / Материалы рекомендованы для использования в частных домах и коммерческих помещениях, подверженных средне-сильному абразивному воздействию

H (Fango, Arancio, Tappeto 3, 4, 6, 8, Abitare Mix: Naturale/Matt)

Materiali consigliati per sollecitazioni all'abrasione relativamente forti in ambienti anche non protetti da agenti graffianti / Materials recommended for relatively heavy abrasion levels, also in premises not protected against abrasive substances / Materials recommended for relatively heavy abrasion levels, also in premises not protected against abrasive substances / Empfohlen für starke Abriebbeanspruchungen in Bereichen auch ohne Kratzschutzbehandlung / Matériaux recommandés pour des locaux soumis à des fortes contraintes d'abrasion, même non protégés contre les agents abrasifs / Materiales recomendados para soportar esfuerzos de abrasión relativamente intensos incluso en espacios no protegidos frente a agentes abrasivos / Материалы рекомендованы для относительно сильного абразивного воздействия, в том числе в помещениях, не защищенных от царапающих элементов

DECORI / DECORATIVE PIECES / DEKORE / DÉCORS / DECORACIONES / ДЕКОРЫ

Abitare Mix

15 diversi soggetti / 15 different motifs / 15 verschiedene Motive / 15 sujets différents / 15 temas diferentes / 15 различных рисунка

CONSIGLI DI POSA / INSTALLATION ADVICE / HINWEISE ZUR VERLEGUNG / CONSEILS DE POSE / SUGERENCIAS PARA LA COLOCACIÓN / РЕКОМЕНДАЦИИ ПО УКЛАДКЕ

Tappeto 1, 2, 3, 4, 5, 6, 7, 8

Posa 90° senso orario / 90° clockwise installation / Verband im 90-Grad-Winkel, im Uhrzeigersinn / Pose à 90° dans le sens des aiguilles d'une montre / Colocación 90° sentido de las agujas del reloj / Укладка под 90° по часовой стрелке

CARATTERISTICHE / CHARACTERISTICS / EIGENSCHAFTEN / CARACTERISTIQUES / DATOS / ХАРАКТЕРИСТИКИ

R9	PENDULUM classe 1	D-COF > 0,42	BCR $\mu > 0,40$
$\leq 175 \text{ mm}^2$			

CERTIFICAZIONI / CERTIFICATIONS / ZERTIFIZIERUNGEN / CERTIFICACIONES / СЕРТИФИКАЦИИ



IMBALLI / PACKAGING / VERPACKUNGEN / EMBALLAGES / EMBALAJES / УПАКОВКИ

		scatole / box / karton / boîte / caja / короб			pallet / pallet / palette / palette / pallet / поддон			
		□	M²	KG	□	M²	KG	± mm
20x20		24	0,96	21,46	54	51,84	1158,94	10
20x20	Tappeto	24	0,96	21,46	54	51,84	1158,94	10
20x20	Abitare Mix	24	0,96	21,46	54	51,84	1158,94	10

STORIE

# A\_Mano



R6MP Vulcano 20x20 - 7<sup>16</sup> x 7<sup>16</sup> - R6MZ Decoro Tappeto 1 Crema 20x20 - 7<sup>16</sup> x 7<sup>16</sup>



## A\_Mano

gres porcellanato / porcelain stoneware / feinsteinzeug / grès cérame émaillé / gres porcelánico / керамогранит

gruppo Bla UNI EN 14411\_6



semi-matt



20x20 cm

7<sup>16</sup> x 7<sup>16</sup>

± 10 mm

# A\_Mano

20x20 - 7<sup>16</sup> x 7<sup>16</sup>

## Bianco Antico



R6MM 20x20

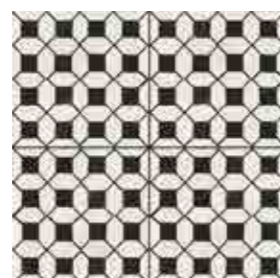

R6NT 20x20 Tappeto 1



R6NW 20x20 Tappeto 2

## Crema



R6ML 20x20

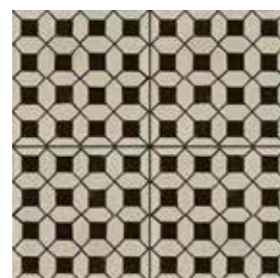

R6MZ 20x20 Tappeto 1



R6NV 20x20 Tappeto 2

## Ardesia



R6MN 20x20

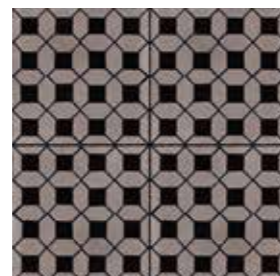

R6NU 20x20 Tappeto 1



R6NX 20x20 Tappeto 2

## Vulcano

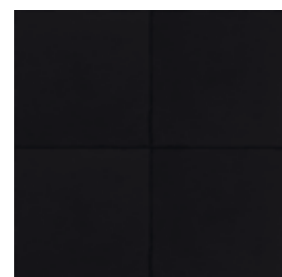

R6MP 20x20

## Decors



R6MS 20x20 Decoro Mix Bianco Antico

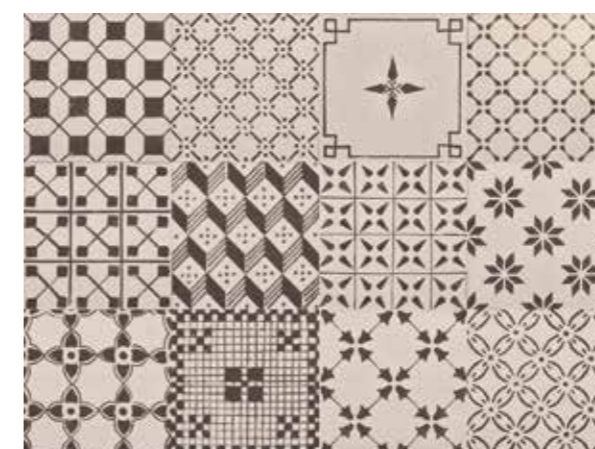

R6MQ 20x20 Decoro Mix Crema

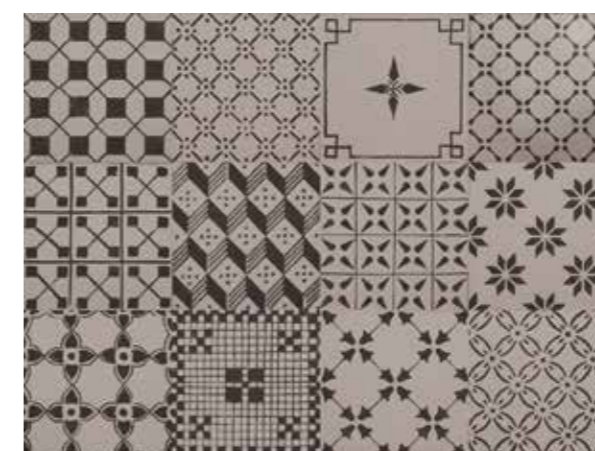

R6MT 20x20 Decoro Mix Ardesia





R6MQ Decoro Mix Crema 20x20 - 71/8" x 71/8" - R6ML Crema 20x20 - 71/8" x 71/8"

TECH INFO

DESTINAZIONE D'USO / INTENDED USE / ANWENDUNGSBEREICH / CHAMP D'APPLICATION / USO PREVISTO / НАЗНАЧЕНИЕ

G (Bianco Antico, Crema: Naturale/Matt)

Materiali consigliati per locali sottoposti a sollecitazioni all'abrasione medio pesanti come: case individuali, commerciale leggero / Materials recommended for premises with medium-heavy abrasion levels, such as: detached homes, light-traffic commercial premises / Empfohlen für Räume mit mittelschwerer Abriebbeanspruchung wie: Einfamilienhäuser, leicht beanspruchte Gewerbebereiche / Matériaux recommandés pour des locaux soumis à des contraintes d'abrasion moyennes et fortes comme : maisons particulières, espaces commerciaux soumis à un trafic léger, etc / Materiales recomendados para locales sometidos a esfuerzos de abrasión medio-pesados, como casas unifamiliares y locales comerciales de tráfico ligero / Материалы рекомендованы для использования в частных домах и коммерческих помещениях, подверженных средне-сильному абразивному воздействию

F (Ardesia, Vulcano, Tappeto 1, 2, Decoro Mix: Naturale/Matt)

Materiali consigliati per qualsiasi locale di un'abitazione che non abbia collegamenti diretti con l'esterno o accessi non protetti da zerbini. Medie sollecitazioni all'abrasione / Tiles suitable for any room of a house without direct access from the outside or access not protected by doormats. Mean stress abrasive wear / Für alle Räume des Wohnbereichs empfohlen, zu denen man keinen direkten Zutritt von außen hat oder welche nicht durch Fußteppiche abgegrenzt sind. Mittlere Abriebbeanspruchung / Matériaux conseillés pour toutes les pièces d'une maison qui n'a pas d'accès directs par l'extérieur ou non protégés par des paillasons. Abrasion sous contraintes moyennes / Materiales aconsejados para cualquier habitación de una vivienda sin accesos directos desde el exterior o accesos no protegidos por felpudos. Esfuerzos medianos por abrasión / Материалы рекомендованы для любых жилых помещений, не имеющих прямого выхода на улицу или же доступа без входных ковриков. Среднее абразивное воздействие

DECORI / DECORATIVE PIECES / DEKORE / DÉCORS / DECORACIONES / ДЕКОРЫ

Decoro Mix

12 diversi soggetti / 12 different motifs / 12 verschiedene Motive / 12 sujets différents / 12 temas diferentes / 12 различных рисунка

CERTIFICAZIONI / CERTIFICATIONS / ZERTIFIZIERUNGEN / CERTIFICACIONES / СЕРТИФИКАЦИИ



IMBALLI / PACKAGING / VERPACKUNGEN / EMBALLAGES / EMBALAJES / УПАКОВКИ

	scatole / box / karton / boîte / caja / короб			pallet / pallet / palette / palette / pallet / поддон			
	□	M²	KG	□	M²	KG	± mm
20x20	24	0,96	21	54	51,84	1048,00	10

# Ottocento



RKMP Ambra 20x20 - 7<sup>16</sup> x 7<sup>16</sup> - RKMN Terra 20x20 - 7<sup>16</sup> x 7<sup>16</sup> - RKMU Ocra 20x20 - 7<sup>16</sup> x 7<sup>16</sup> - RKMQ Talco 20x20 - 7<sup>16</sup> x 7<sup>16</sup>



## Ottocento

gres porcellanato / porcelain stoneware / feinsteinzeug / grès cérame émaillé / gres porcelánico / керамогранит

gruppo Bla UNI EN 14411\_6



20x20 cm  
7<sup>16</sup> x 7<sup>16</sup>  
± 10 mm

# Ottocento

20x20 - 7 1/8" x 7 1/8"

Talco



RKMQ 20x20

Basalto



RKMS 20x20

Talco



R86Z 20x20 Tappeto 1



R87D 20x20 Tappeto 5

Ambra



RKMP 20x20

Cobalto



RKMM 20x20



R873 20x20 Tappeto 2



R87E 20x20 Tappeto 6

Pomice



RKMR 20x20

Cadmio



RKMT 20x20



R87A 20x20 Tappeto 3



R87F 20x20 Tappeto 7

Terra



RKMN 20x20

Ocra



RKMU 20x20



R87C 20x20 Tappeto 4



R87G 20x20 Tappeto 8

# Ottocento

20x20 - 7 1/8" x 7 1/8"

## Ambra



R86R 20x20 Tappeto



R86V 20x20 Tappeto 5



R86S 20x20 Tappeto 2

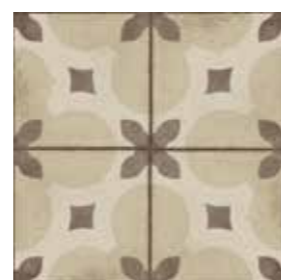

R86W 20x20 Tappeto 6



R86T 20x20 Tappeto 3



R86X 20x20 Tappeto 7



R86U 20x20 Tappeto 4



R86Y 20x20 Tappeto 8

## Decors



RFFX 20x20 Decoro Mix Talco



RFFW 20x20 Decoro Mix Ambra



R86W Decoro Tappeto 6 Ambra 20x20 - 778x778

TECH INFO

VARIAZIONI CROMATICHE / COLOUR VARIATIONS / FARBVARIATIONEN / VARIACIONES CROMATICAS / ВАРИАНТЫ ОТТЕНКА



Apprezzabili differenze nell'aspetto di superficie e grafica all'interno della stessa produzione / Clearly distinguishable differences in texture and pattern within the same production run / Auffällige Unterschiede in Aussehen und Struktur innerhalb der gleichen Produktionscharge / Différences visibles au niveau de l'aspect et de la fantaisie entre les carreaux du même lot de production / Diferencias visibles en el aspecto de la superficie y los motivos dentro de un mismo lote de producción / заметные отличия вида поверхности и графики в одной и той же партии

DESTINAZIONE D'USO / INTENDED USE / ANWENDUNGSBEREICH / CHAMP D'APPLICATION / USO PREVISTO / НАЗНАЧЕНИЕ

G (Cobalto: Naturale/Matt)

Materiali consigliati per locali sottoposti a sollecitazioni all'abrasione medio pesanti come: case individuali, commerciale leggero / Materials recommended for premises with medium-heavy abrasion levels, such as: detached homes, light-traffic commercial premises / Empfohlen für Räume mit mittelschwerer Abriebbeanspruchung wie: Einfamilienhäuser, leicht beanspruchte Gewerbebereiche / Matériaux recommandés pour des locaux soumis à des contraintes d'abrasion moyennes et fortes comme : maisons particulières, espaces commerciaux soumis à un trafic léger, etc / Materiales recomendados para locales sometidos a esfuerzos de abrasión medio-pesados, como casas unifamiliares y locales comerciales de tráfico ligero / Материалы рекомендованы для использования в частных домах и коммерческих помещениях, подверженных средне-сильному абразивному воздействию

H (Talco, Pomice, Basalto, Ambra, Terra, Ocra, Cadmio, Tappeto 1, 2, 3, 4, 5, 6, 7, 8, Decoro Mix: Naturale/Matt)

Materiali consigliati per sollecitazioni all'abrasione relativamente forti in ambienti anche non protetti da agenti graffianti / Materials recommended for relatively heavy abrasion levels, also in premises not protected against abrasive substances / Materials recommended for relatively heavy abrasion levels, also in premises not protected against abrasive substances / Empfohlen für starke Abriebbeanspruchungen in Bereichen auch ohne Kratzschutzbehandlung / Matériaux recommandés pour des locaux soumis à des fortes contraintes d'abrasion, même non protégés contre les agents abrasifs / Materiales recomendados para soportar esfuerzos de abrasión relativamente intensos incluso en espacios no protegidos frente a agentes abrasivos / Материалы рекомендованы для относительно сильного абразивного воздействия, в том числе в помещениях, не защищенных от царапающих элементов

DECORI / DECORATIVE PIECES / DEKORE / DÉCORS / DECORACIONES / ДЕКОРЫ

Decoro Mix

20 diversi soggetti / 20 different motifs / 20 verschiedene Motive / 20 sujets différents / 20 temas diferentes / 20 различных рисунка

CONSIGLI DI POSA / INSTALLATION ADVICE / HINWEISE ZUR VERLEGUNG / CONSEILS DE POSE / SUGERENCIAS PARA LA COLOCACIÓN / РЕКОМЕНДАЦИИ ПО УКЛАДКЕ

Tappeto 2, 4, 5, 6, 8

Posa 90° senso orario / 90° clockwise installation / Verband im 90-Grad-Winkel, im Uhrzeigersinn / Pose à 90° dans le sens des aiguilles d'une montre / Colocación 90° sentido de las agujas del reloj / Укладка под 90° по часовой стрелке

CARATTERISTICHE / CHARACTERISTICS / EIGENSCHAFTEN / CARACTERISTIQUES / DATOS / ХАРАКТЕРИСТИКИ

R9	PENDULUM classe 1	D-COF > 0,42	BCR μ > 0,40
----	-------------------	--------------	--------------

CERTIFICAZIONI / CERTIFICATIONS / ZERTIFIZIERUNGEN / CERTIFICACIONES / СЕРТИФИКАЦИИ



IMBALLI / PACKAGING / VERPACKUNGEN / EMBALLAGES / EMBALAJES / УПАКОВКИ

	scatole / box / karton / boîte / caja / короб			pallet / pallet / palette / palette / pallet / поддон			
	□	M²	KG	□	M²	KG	± mm
20x20	24	0,96	21,43	54	51,84	1157,00	10

# MARBLE EFFECT

- 90 Incanto
- 106 Maiora Marble
- 116 Bistrot
- 126 Imperiale





# Incanto

120x278 - 47<sup>1/4</sup>"x109<sup>3/16</sup>" 120x120 - 47<sup>1/4</sup>"x47<sup>1/4</sup>" 75x150 - 29<sup>1/2</sup>"x59<sup>1/16</sup>" 75x75 - 29<sup>1/2</sup>"x29<sup>1/2</sup>" 60x120 - 23<sup>5/8</sup>"x47<sup>1/4</sup>" 60x60 - 23<sup>5/8</sup>"x23<sup>5/8</sup>" 30x60 - 11<sup>13/16</sup>"x23<sup>5/8</sup>" 30x30 - 11<sup>13/16</sup>"x11<sup>13/16</sup>" 28,1x31 - 11<sup>1/16</sup>"x12<sup>3/16</sup>"

## Calacatta Nobile



Marble Effect variations 120x278

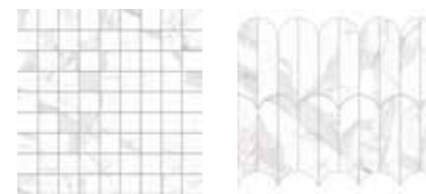

**R96L** 30x30 Mosaico **R9CE** 28,1x31 Mosaico  
**R95Z** 30x30 Mosaico Glossy Ventaglio Glossy

**R94W** 7x60 BT.B.C.  
**R95K** 7x60 BT.B.C. Glossy  
**R93S** 7x75 BT.B.C.  
**R94H** 7x75 BT.B.C. Glossy

**R8ND** 120x278 Glossy Rett  
**R8NP** 120x120 Glossy Rett  
**R8RV** 60x120 Glossy Rett  
**R8NY** 120x278 Rett  
**R8PG** 120x120 Rett  
**R8SF** 60x120 Rett  
**R8TR** 75x150 Rett  
**R8TZ** 75x150 Glossy Rett  
**R8UE** 75x75 Rett  
**R8UN** 75x75 Glossy Rett  
**R8ZT** 60x60 Rett  
**R90G** 60x60 Glossy Rett  
**R90V** 30x60 Rett  
**R91L** 30x60 Glossy Rett

## Statuario Venato

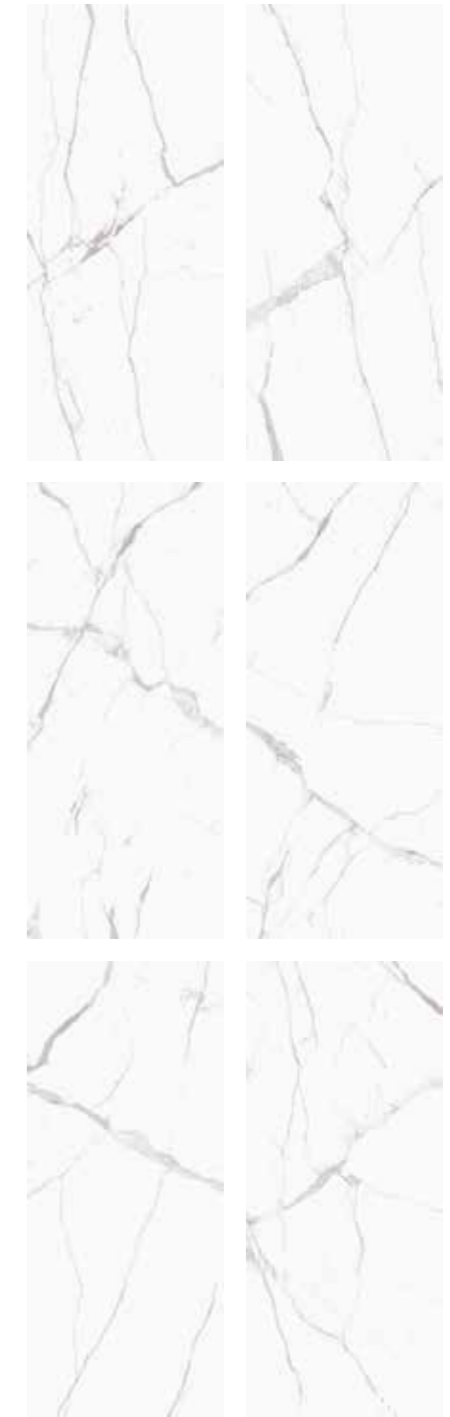

Marble Effect variations 120x278

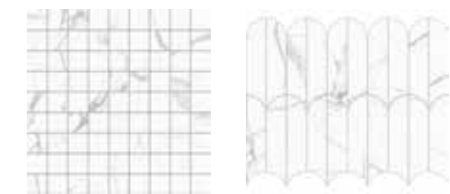

**R96M** 30x30 Mosaico **R9CF** 28,1x31 Mosaico  
**R91** 30x30 Mosaico Glossy Ventaglio Glossy

**R94X** 7x60 BT.B.C.  
**R95L** 7x60 BT.B.C. Glossy  
**R93T** 7x75 BT.B.C.  
**R94J** 7x75 BT.B.C. Glossy

**R8RG** 120x278 Glossy Rett  
**R8QZ** 120x120 Glossy Rett  
**R8RU** 60x120 Glossy Rett  
**R8RE** 120x278 Rett  
**R8RC** 120x120 Rett  
**R8SE** 60x120 Rett  
**R8TS** 75x150 Rett  
**R8U1** 75x150 Glossy Rett  
**R8UF** 75x75 Rett  
**R8UP** 75x75 Glossy Rett  
**R8ZU** 60x60 Rett  
**R90H** 60x60 Glossy Rett  
**R90W** 30x60 Rett  
**R91M** 30x60 Glossy Rett



# Incanto

120x278 - 47<sup>1/4</sup>"x109<sup>3/16</sup>" 120x120 - 47<sup>1/4</sup>"x47<sup>1/4</sup>" 75x150 - 29<sup>1/2</sup>"x59<sup>1/16</sup>" 75x75 - 29<sup>1/2</sup>"x29<sup>1/2</sup>" 60x120 - 23<sup>5/8</sup>"x47<sup>1/4</sup>" 60x60 - 23<sup>5/8</sup>"x23<sup>5/8</sup>" 30x60 - 11<sup>13/16</sup>"x23<sup>5/8</sup>" 30x30 - 11<sup>13/16</sup>"x11<sup>13/16</sup>" 28,1x31 - 11<sup>1/8</sup>"x12<sup>3/16</sup>"

## Paonazzetto



Marble Effect variations 120x278



**R96N** 30x30 Mosaico  
**R963** 30x30 Mosaico Glossy

**R94Y** 7x60 BT.B.C.  
**R95M** 7x60 BT.B.C. Glossy  
**R93U** 7x75 BT.B.C.  
**R94K** 7x75 BT.B.C. Glossy

**R8TA** 120x278 Glossy Rett  
**R8SX** 120x120 Glossy Rett  
**R8TF** 60x120 Glossy Rett  
**R8UU** 120x278 Rett  
**R8ZC** 75x150 Rett  
**R8XS** 75x150 Glossy Rett  
**R8ZJ** 75x75 Rett  
**R8XZ** 75x75 Glossy Rett  
**R8ZV** 60x60 Rett  
**R90J** 60x60 Glossy Rett  
**R90X** 30x60 Rett  
**R91N** 30x60 Glossy Rett

## Calacatta Michelangelo



Marble Effect variations 120x278



**R96E** 30x30 Mosaico  
**R95S** 30x30 Mosaico Glossy  
**R9CA** 28,1x31 Mosaico Ventaglio Glossy

**R94Q** 7x60 BT.B.C.  
**R95C** 7x60 BT.B.C. Glossy  
**R93K** 7x75 BT.B.C.  
**R93Z** 7x75 BT.B.C. Glossy

**R8NG** 120x278 Glossy Rett  
**R8NS** 120x120 Glossy Rett  
**R8RW** 60x120 Glossy Rett  
**R8PA** 120x278 Rett  
**R8PJ** 120x120 Rett  
**R8SG** 60x120 Rett  
**R8Z4** 75x150 Rett  
**R8XM** 75x150 Glossy Rett  
**R8ZE** 75x75 Rett  
**R8XU** 75x75 Glossy Rett  
**R8ZL** 60x60 Rett  
**R901** 60x60 Glossy Rett  
**R90P** 30x60 Rett  
**R91D** 30x60 Glossy Rett

# Incanto

Crema  
Delicato



<b>R8NF</b> 120x278 Glossy Rett	<b>R8XN</b> 75x150 Glossy Rett
<b>R8NR</b> 120x120 Glossy Rett	<b>R8ZF</b> 75x75 Rett
<b>R8RX</b> 60x120 Glossy Rett	<b>R8XV</b> 75x75 Glossy Rett
<b>R8NZ</b> 120x278 Rett	<b>R8ZM</b> 60x60 Rett
<b>R8PH</b> 120x120 Rett	<b>R902</b> 60x60 Glossy Rett
<b>R8SH</b> 60x120 Rett	<b>R90Q</b> 30x60 Rett
<b>R8Z5</b> 75x150 Rett	<b>R91E</b> 30x60 Glossy Rett



Marble Effect variations 120x278



**R96F** 30x30 Mosaico  
**R95T** 30x30 Mosaico Glossy



**R94R** 7x60 BT.B.C.  
**R95D** 7x60 BT.B.C. Glossy  
**R93L** 7x75 BT.B.C.  
**R94A** 7x75 BT.B.C. Glossy

120x278 - 47<sup>1/4</sup>"x109<sup>3/16</sup>" 120x120 - 47<sup>1/4</sup>"x47<sup>1/4</sup>" 75x150 - 29<sup>1/2</sup>"x59<sup>1/16</sup>" 75x75 - 29<sup>1/2</sup>"x29<sup>1/2</sup>" 60x120 - 23<sup>5/8</sup>"x47<sup>1/4</sup>" 60x60 - 23<sup>5/8</sup>"x23<sup>5/8</sup>" 30x60 - 11<sup>13/16</sup>"x23<sup>5/8</sup>" 30x30 - 11<sup>13/16</sup>"x11<sup>13/16</sup>" 28,1x31 - 11<sup>1/8</sup>"x12<sup>3/16</sup>"

Breccia Aurora



Marble Effect variations 120x278



**R96G** 30x30 Mosaico  
**R95U** 30x30 Mosaico Glossy  
**R9CC** 28,1x31 Mosaico Ventaglio Glossy



**R94S** 7x60 BT.B.C.  
**R95E** 7x60 BT.B.C. Glossy  
**R93N** 7x75 BT.B.C.  
**R94C** 7x75 BT.B.C. Glossy

<b>R8NC</b> 120x278 Glossy Rett	<b>R8TX</b> 75x150 Glossy Rett
<b>R8NN</b> 120x120 Glossy Rett	<b>R8UC</b> 75x75 Rett
<b>R8RY</b> 60x120 Glossy Rett	<b>R8UL</b> 75x75 Glossy Rett
<b>R8NX</b> 120x278 Rett	<b>R8ZN</b> 60x60 Rett
<b>R8PF</b> 120x120 Rett	<b>R90A</b> 60x60 Glossy Rett
<b>R8SJ</b> 60x120 Rett	<b>R90R</b> 30x60 Rett
<b>R8TP</b> 75x150 Rett	<b>R91F</b> 30x60 Glossy Rett

# Incanto

Breccia  
Pernice

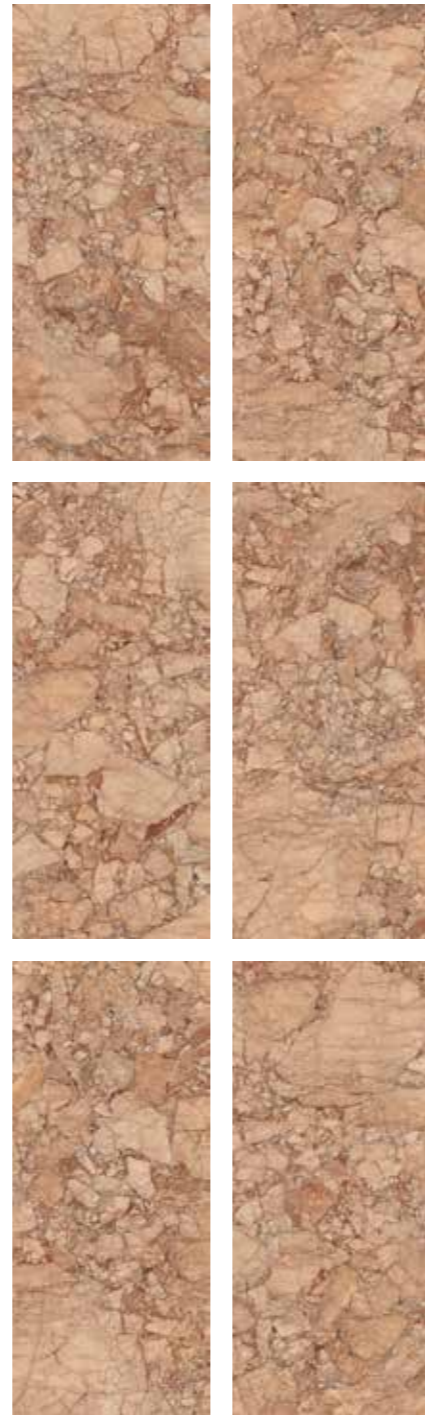

Marble Effect variations 120x278



**R96H** 30x30 Mosaico **R9CD** 28,1x31 Mosaico  
**R95V** 30x30 Mosaico Glossy Ventaglio Glossy

**R94T** 7x60 BT.B.C.  
**R95F** 7x60 BT.B.C. Glossy  
**R93P** 7x75 BT.B.C.  
**R94D** 7x75 BT.B.C. Glossy

**R8MZ** 120x278 Glossy Rett  
**R8NL** 120x120 Glossy Rett  
**R8RZ** 60x120 Glossy Rett  
**R8TQ** 75x150 Rett  
**R8TY** 75x150 Glossy Rett  
**R8UD** 75x75 Rett  
**R8UM** 75x75 Glossy Rett  
**R8ZP** 60x60 Rett  
**R90C** 60x60 Glossy Rett  
**R90S** 30x60 Rett  
**R91G** 30x60 Glossy Rett

120x278 - 47<sup>1/4</sup>"x109<sup>3/16</sup>" 120x120 - 47<sup>1/4</sup>"x47<sup>1/4</sup>" 75x150 - 29<sup>1/2</sup>"x59<sup>1/16</sup>" 75x75 - 29<sup>1/2</sup>"x29<sup>1/2</sup>" 60x120 - 23<sup>5/8</sup>"x47<sup>1/4</sup>" 60x60 - 23<sup>5/8</sup>"x23<sup>5/8</sup>" 30x60 - 11<sup>13/16</sup>"x23<sup>5/8</sup>" 30x30 - 11<sup>13/16</sup>"x11<sup>13/16</sup>" 28,1x31 - 11<sup>1/16</sup>"x12<sup>3/16</sup>"

Verde Antigua



Marble Effect variations 120x278



**R96P** 30x30 Mosaico **R9CG** 28,1x31 Mosaico  
**R97** 30x30 Mosaico Glossy Ventaglio Glossy

**R94Z** 7x60 BT.B.C.  
**R95N** 7x60 BT.B.C. Glossy  
**R93V** 7x75 BT.B.C.  
**R94L** 7x75 BT.B.C. Glossy

**R8NJ** 120x278 Glossy Rett  
**R8NU** 120x120 Glossy Rett  
**R8SA** 60x120 Glossy Rett  
**R8TT** 75x150 Rett  
**R8U3** 75x150 Glossy Rett  
**R8UG** 75x75 Rett  
**R8UQ** 75x75 Glossy Rett  
**R8ZW** 60x60 Rett  
**R90K** 60x60 Glossy Rett  
**R90Y** 30x60 Rett  
**R91P** 30x60 Glossy Rett

# Incanto

120x278 - 47<sup>1/4</sup>"x109<sup>3/16</sup>" 120x120 - 47<sup>1/4</sup>"x47<sup>1/4</sup>" 75x150 - 29<sup>1/2</sup>"x59<sup>1/16</sup>" 75x75 - 29<sup>1/2</sup>"x29<sup>1/2</sup>" 60x120 - 23<sup>5/8</sup>"x47<sup>1/4</sup>" 60x60 - 23<sup>5/8</sup>"x23<sup>5/8</sup>" 30x60 - 11<sup>13/16</sup>"x23<sup>5/8</sup>" 30x30 - 11<sup>13/16</sup>"x11<sup>13/16</sup>" 28,1x31 - 11<sup>1/16</sup>"x12<sup>3/16</sup>"

## Bardiglio



Marble Effect variations 120x278

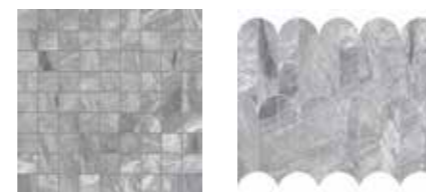

**R96Q** 30x30 Mosaico **R9CH** 28,1x31 Mosaico  
**R96A** 30x30 Mosaico Glossy Ventaglio Glossy

<b>R8NE</b> 120x278 Glossy Rett	<b>R8ZX</b> 60x60 Rett
<b>R8NQ</b> 120x120 Glossy Rett	<b>R90L</b> 60x60 Glossy Rett
<b>R8S7</b> 60x120 Glossy Rett	<b>R90Z</b> 30x60 Rett
<b>R8TU</b> 75x150 Rett	<b>R91Q</b> 30x60 Glossy Rett
<b>R8U2</b> 75x150 Glossy Rett	
<b>R8UH</b> 75x75 Rett	
<b>R8UR</b> 75x75 Glossy Rett	

<b>R954</b> 7x60 BT.B.C.	
<b>R95P</b> 7x60 BT.B.C. Glossy	
<b>R93W</b> 7x75 BT.B.C.	
<b>R94M</b> 7x75 BT.B.C. Glossy	

## Crux Grey



Marble Effect variations 120x278



**R96J** 30x30 Mosaico  
**R95W** 30x30 Mosaico Glossy

<b>R8NH</b> 120x278 Glossy Rett	<b>R8XP</b> 75x150 Glossy Rett
<b>R8NT</b> 120x120 Glossy Rett	<b>R8ZG</b> 75x75 Rett
<b>R8S9</b> 60x120 Glossy Rett	<b>R8XW</b> 75x75 Glossy Rett
<b>R8PC</b> 120x278 Rett	<b>R8ZQ</b> 60x60 Rett
<b>R8PK</b> 120x120 Rett	<b>R90D</b> 60x60 Glossy Rett
<b>R8SK</b> 60x120 Rett	<b>R90T</b> 30x60 Rett
<b>R8Z7</b> 75x150 Rett	<b>R91H</b> 30x60 Glossy Rett

<b>R94U</b> 7x60 BT.B.C.	
<b>R95G</b> 7x60 BT.B.C. Glossy	
<b>R93Q</b> 7x75 BT.B.C.	
<b>R94E</b> 7x75 BT.B.C. Glossy	

# Incanto

120x278 - 47<sup>1/4</sup>"x109<sup>3/8</sup>" 120x120 - 47<sup>1/4</sup>"x47<sup>1/4</sup>" 75x150 - 29<sup>1/2</sup>"x59<sup>1/8</sup>" 75x75 - 29<sup>1/2</sup>"x29<sup>1/2</sup>" 60x120 - 23<sup>5/8</sup>"x47<sup>1/4</sup>" 60x60 - 23<sup>5/8</sup>"x23<sup>5/8</sup>" 30x60 - 11<sup>13/16</sup>"x23<sup>5/8</sup>" 30x30 - 11<sup>13/16</sup>"x11<sup>13/16</sup>" 28,1x31 - 11<sup>1/8</sup>"x12<sup>3/16</sup>"

## Grafite



Marble Effect variations 120x278

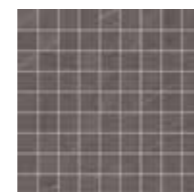

R96K 30x30 Mosaico  
R95X 30x30 Mosaico Glossy



R94V 7x60 BT.B.C.  
R95H 7x60 BT.B.C. Glossy  
R93R 7x75 BT.B.C.  
R94F 7x75 BT.B.C. Glossy

<b>R8SZ</b> 120x278 Glossy Rett	<b>R8XQ</b> 75x150 Glossy Rett
<b>R8SV</b> 120x120 Glossy Rett	<b>R8ZH</b> 75x75 Rett
<b>R8TD</b> 60x120 Glossy Rett	<b>R8XX</b> 75x75 Glossy Rett
<b>R8TH</b> 120x278 Rett	<b>R8ZR</b> 60x60 Rett
<b>R8TK</b> 120x120 Rett	<b>R90E</b> 60x60 Glossy Rett
<b>R8TM</b> 60x120 Rett	<b>R90U</b> 30x60 Rett
<b>R8ZA</b> 75x150 Rett	<b>R91J</b> 30x60 Glossy Rett

## Emperador

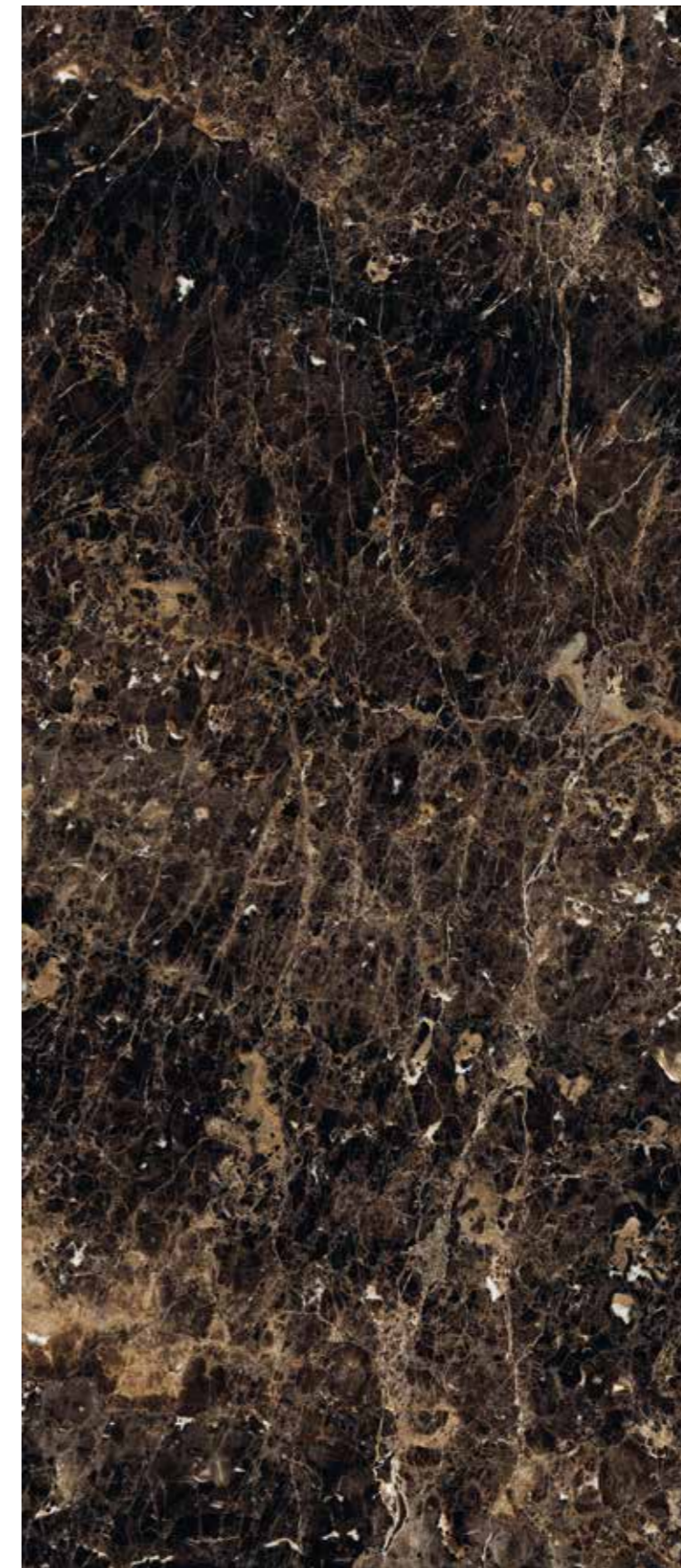

Marble Effect variations 120x278

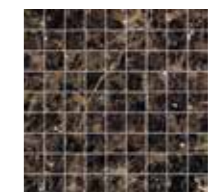

R95Y 30x30 Mosaico Glossy



R95J 7x60 BT.B.C. Glossy  
R94G 7x75 BT.B.C. Glossy

<b>R8T0</b> 120x278 Glossy Rett
<b>R8SW</b> 120x120 Glossy Rett
<b>R8TE</b> 60x120 Glossy Rett
<b>R8XR</b> 75x150 Glossy Rett
<b>R8XY</b> 75x75 Glossy Rett
<b>R90F</b> 60x60 Glossy Rett
<b>R91K</b> 30x60 Glossy Rett

Sky Black



Marble Effect variations 120x278

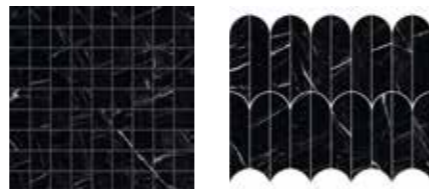

R96R 30x30 Mosaico R96C 30x30 Mosaico Glossy R9CJ 28,1x31 Mosaico Ventaglio Glossy

R8NA	120x278	Glossy Rett	R8U4	75x150	Glossy Rett
R8NM	120x120	Glossy Rett	R8UJ	75x75	Rett
R8SC	60x120	Glossy Rett	R8US	75x75	Glossy Rett
R8NW	120x278	Rett	R8ZY	60x60	Rett
R8PE	120x120	Rett	R90M	60x60	Glossy Rett
R8SL	60x120	Rett	R91A	30x60	Rett
R8TV	75x150	Rett	R91R	30x60	Glossy Rett

R959	7x60	BT.B.C.
R95Q	7x60	BT.B.C. Glossy
R93X	7x75	BT.B.C.
R94N	7x75	BT.B.C. Glossy

TECH INFO

VARIACIONI CROMATICHE / COLOUR VARIATIONS / FARBVARIATIONEN / VARIACIONES CROMÁTICAS / ВАРИАНТЫ ОТТЕНКА

V2 (Calacatta Nobile, Statuario Venato, Verde Antigua, Sky Black)

Apprezzabili differenze nell'aspetto di superficie e grafica all'interno della stessa produzione / Clearly distinguishable differences in texture and pattern within the same production run / Auffällige Unterschiede in Aussehen und Struktur innerhalb der gleichen Produktionscharge / Différences visibles au niveau de l'aspect et de la fantaisie entre les carreaux du même lot de production / Diferencias visibles en el aspecto de la superficie y los motivos dentro de un mismo lote de producción / заметные отличия вида поверхности и графики в одной и той же партии

V3 (Paonazzetto, Calacatta Michelangelo, Breccia Aurora, Emperador, Breccia Pernice, Bardiglio, Graphite, Crema Delicata)

Significativa variazione di aspetto superficiale, grafica e colore da piastrella a piastrella e all'interno della stessa piastrella. Si consiglia di visionare la gamma cromatica prima della selezione del materiale / Significant variation in texture, pattern and colour from tile to tile within the same production run. The colour range should be viewed before selecting the material / Bedeutende Variation in Aussehen, Struktur und Farbe von Fliese zu Fliese und in ein und derselben Fliese. Es wird empfohlen, das Farbsortiment vor der Auswahl des Materials zu prüfen / Variation significative au niveau de l'aspect, de la fantaisie et de la couleur entre les carreaux et au sein d'un même carreau. Il est recommandé de consulter la gamme des couleurs avant de sélectionner le matériel / Variación considerable en el aspecto superficial, los motivos y el color entre un azulejo y otro y dentro del propio azulejo. Es aconsejable visualizar la gama cromática antes de seleccionar el material / Значительные отличия вида поверхности, графики и цвета у разных плиток и на одной и той же плитке. Перед отбором материала рекомендуется посмотреть цветовую гамму

V4 (Cruix Grey)

Variazioni irregolari da piastrella a piastrella. Una piastrella può differire totalmente nell'aspetto superficiale e colore da un'altra. Si consiglia divisionare la gamma cromatica prima della selezione del materiale / Random differences from tile to tile. One tile may have totally different texture and colour from another. The colour range should be viewed before selecting the material / Wesentliche Variationen von Fliese zu Fliese. Eine Fliese kann sich in Aussehen und Farbe komplett von einer anderen unterscheiden. Es wird empfohlen, das Farbsortiment vor der Auswahl des Materials zu prüfen / Variations irrégulières entre les carreaux. L'aspect et la couleur peuvent être complètement différents d'un carreau à l'autre. Il est recommandé de consulter la gamme des couleurs avant de sélectionner le matériel / Variaciones irregulares entre un azulejo y otro. Un azulejo puede ser completamente diferente de otro en el aspecto superficial y el color. Es aconsejable visualizar la gama cromática antes de seleccionar el material / Неоднородные изменения на разных плитках. Каждая плитка может полностью отличаться по виду поверхности и цвету от другой. Перед отбором материала рекомендуется посмотреть цветовую гамму

DESTINAZIONE D'USO / INTENDED USE / ANWENDUNGSBEREICH / CHAMP D'APPLICATION / USO PREVISTO / НАЗНАЧЕНИЕ

vedi pag 689 / see page 689 / siehe Anhang 689 / voir page 689 / véase la pág. 689 / смотри на стр. 689

G (Naturale/Matt) F (Glossy)

DECORI / DECORATIVE PIECES / DEKORE / DÉCORS / DECORACIONES / ДЕКОРЫ

Mosaico 30x30

Mosaico assemblato con tratto plastico / Spot-bonded mosaic / Punktverklebtes Mosaik / Mosaïque montée avec trait de colle / Mosaico colocado aplicando cola plástica / Мозаика с сегментами, выполненными из пластмассы - Мозаика, собранная на клеевой точке

Mosaico Ventaglio 28,1x31

Mosaico assemblato su rete in fibra di vetro / Mosaic mesh - mounted on fibreglass / Auf Glasfasernetz geklebtes Mosaik / Mosaïque montée sur filet en fibre de verre / Mosaico enmallado sobre fibra de vidrio / Мозаика, собранная на сетке из стекловолокна

PEZZI SPECIALI / TRIMS / SPEZIALTEILE / PIÈCES SPÉCIALES / PIEZAS ESPECIALES / СПЕЦИАЛЬНЫЕ ИЗДЕЛИЯ

BT.B.C.

Battiscopa Becco Civetta ottenuto da taglio del fondo / Coved Edge Skirting Tile cut from plain tile / Sockelleiste, Halbrundstab, aus Grundfliese geschnitten / Plinthe bord rond découpée dans le fond / Rodapié canto romo conseguido mediante corte del fondo / Плинтус с закругленным краем, полученный из фоновой плитки

CARATTERISTICHE / CHARACTERISTICS / EIGENSCHAFTEN / CARACTERISTIQUES / DATOS / ХАРАКТЕРИСТИКИ

R9	Naturale/Matt	PENDULUM	D-COF	BCR
		classe 1	> 0,42	μ > 0,40
		Naturale/Matt	Naturale/Matt	Naturale/Matt
A				
≤ 175 mm <sup>3</sup>				

CERTIFICAZIONI / CERTIFICATIONS / ZERTIFIZIERUNGEN / CERTIFICACIONES / CERTIFICACIONES / СЕРТИФИКАЦИИ



IMBALLI / PACKAGING / VERPACKUNGEN / EMBALLAGES / EMBALAJES / УПАКОВКИ

	scatole / box / karton / boîte / caja / короб			pallet / pallet / palette / palette / pallet / поддон			
	□	M <sup>2</sup>	KG	□	M <sup>2</sup>	KG	± mm
120x120	2	2,88	46,00	20	57,60	919,98	6
60x120	3	2,16	32,00	15	32,40	480,00	6
75x150	2	2,25	55,00	21	47,25	1154,97	10,5
75x75	2	1,13	25,00	42	47,25	1050,00	10
75x75	2	1,13	26,48	42	47,25	1112,29	10,5
60x60	3	1,08	22,50	40	43,20	900,00	9,5
60x60	3	1,08	24,80	40	43,20	991,96	10
30x60	6	1,08	22,01	48	51,84	1056,45	9,5
30x60	6	1,08	22,01	48	51,84	1056,45	10
30x30	4	0,36	7,50	-	-	-	9,5
30x30	4	0,36	8,00	-	-	-	10
28,1x31	4	0,28	8,00	-	-	-	10
7x60	15	9,00 ml	21,00	-	-	-	9,5
7x60	14	8,40 ml	20,50	-	-	-	10
7x75	14	10,50 ml	20,00	-	-	-	10
7x75	13	9,75 ml	20,00	-	-	-	10,5

Imballaggio INCANTO & MAIORA > vedi Appendice / Packaging > see Appendix / Verpackungen > siehe Anhang / Emballages > voir Annexe / Embalajes > véase Apéndice / Упаковки > смотри Приложение

MARBLE EFFECT

# Maiora Marble



R7EQ Paonazetto Glossy Rettificato 120x278 - 47<sup>1/4</sup>"x109<sup>7/16</sup>"



## Maiora Marble

gres fine porcellanato colorato in massa - rettificato monocalibro / colorbody fine porcelain stoneware - rectified monocaliber / durchgefärbtes feinsteinzeug - rektifiziert, in einem werkmaß / grès cérame fin coloré dans la masse - rectifié monocalibre / gres porcelánico fino coloreado en toda la masa - rectificado monocalibre / гомогенный мелкозернистый керамогранит - ректифицированный монокалиберный

gruppo Bia UNI EN 14411\_G



naturale/  
matt

glossy  
matt



120x278 cm  
47<sup>1/4</sup>"x109<sup>7/16</sup>"  
± 6 mm



120x240 cm  
47<sup>1/4</sup>"x94<sup>1/2</sup>"  
± 6 mm

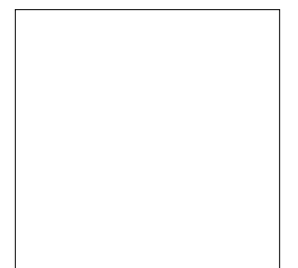

120x120 cm  
47<sup>1/4</sup>"x47<sup>1/4</sup>"  
± 6 mm

# Maiores Marble

120x278 - 47<sup>1/4</sup> x 109<sup>3/8</sup> 120x240 - 47<sup>1/4</sup> x 94<sup>1/2</sup> 120x120 - 47<sup>1/4</sup> x 47<sup>1/4</sup> 34,5x30 - 13<sup>3/8</sup> x 11<sup>13/16</sup> 30x32,5 - 11<sup>13/16</sup> x 12<sup>13/16</sup> 30x30 - 11<sup>13/16</sup> x 11<sup>13/16</sup>

## Paonazetto



Marble Effect variations 120x278

**R7EE** 120x278 Rett  
**R7EQ** 120x278 Glossy Rett

## Arabescato



Marble Effect variations 120x278

**R7EL** 120x278 Glossy Rett  
**R6RM** 120x240 Glossy Rett  
**R6RX** 120x120 Glossy Rett



# Maiora Marble

120x278 - 47<sup>1/4</sup>"x109<sup>3/8</sup>" 120x240 - 47<sup>1/4</sup>"x94<sup>1/2</sup>" 120x120 - 47<sup>1/4</sup>"x47<sup>1/4</sup>" 34,5x30 - 13<sup>3/8</sup>"x11<sup>3/8</sup>" 30x32,5 - 11<sup>13/16</sup>"x12<sup>13/16</sup>" 30x30 - 11<sup>13/16</sup>"x11<sup>13/16</sup>"

## Statuario

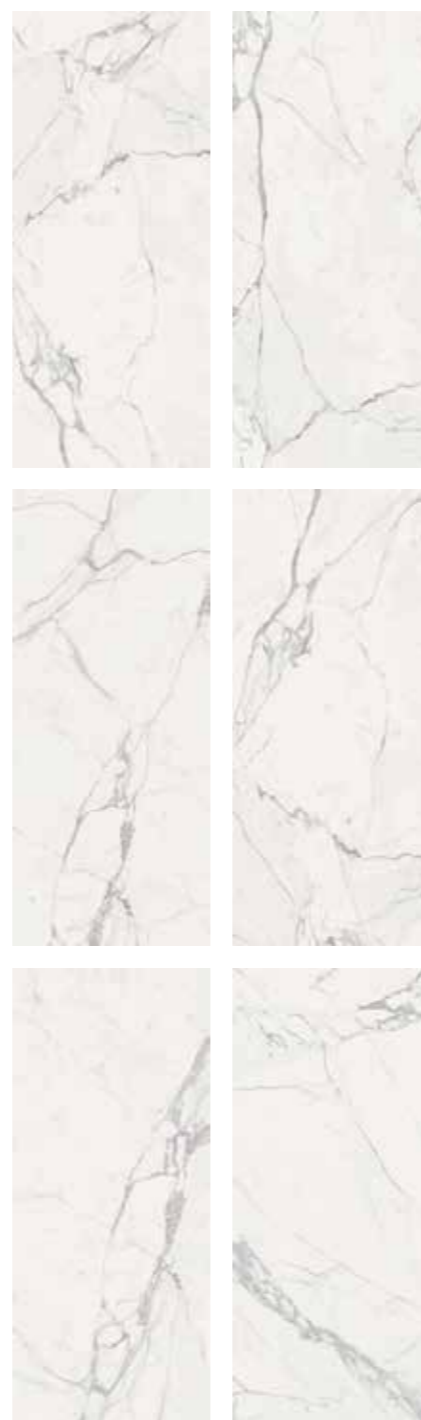

Marble Effect variations 120x278

- R7EH** 120x278 Rett
- R7EM** 120x278 Glossy Rett
- R6RT** 120x240 Rett
- R6RN** 120x240 Glossy Rett
- R6SE** 120x120 Rett
- R6RY** 120x120 Glossy Rett

## Calacatta Oro



Marble Effect variations 120x278

- R7ED** 120x278 Rett
- R7EK** 120x278 Glossy Rett
- R6RS** 120x240 Rett
- R6RL** 120x240 Glossy Rett
- R6SD** 120x120 Rett
- R6RW** 120x120 Glossy Rett

# Maiora Marble

120x278 - 47<sup>1/4</sup>" x 109<sup>5/8</sup>" 120x240 - 47<sup>1/4</sup>" x 94<sup>1/2</sup>" 120x120 - 47<sup>1/4</sup>" x 47<sup>1/4</sup>" 34,5x30 - 13<sup>3/8</sup>" x 11<sup>13/16</sup>" 30x32,5 - 11<sup>13/16</sup>" x 12<sup>13/16</sup>" 30x30 - 11<sup>13/16</sup>" x 11<sup>13/16</sup>"

## Emperador

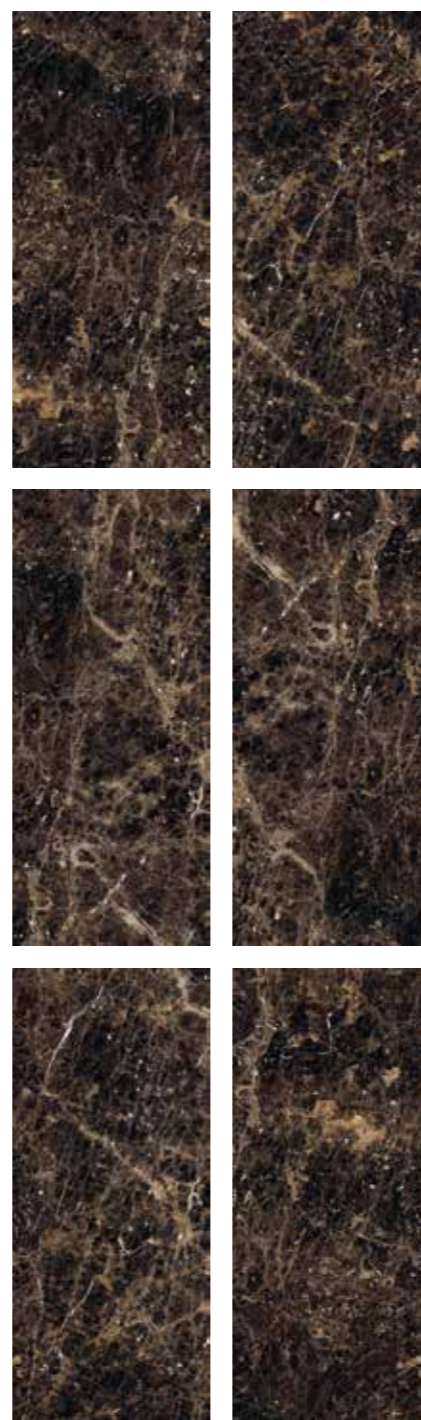
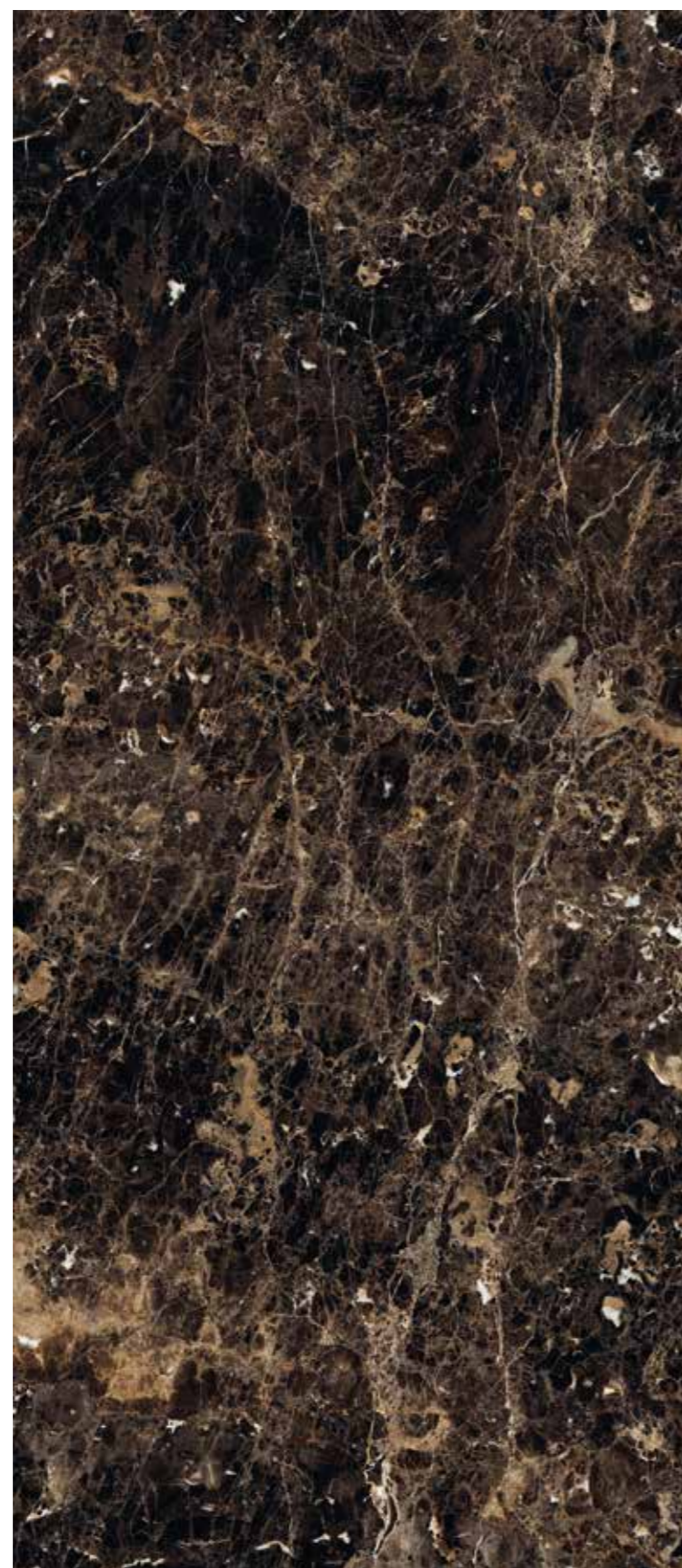

Marble Effect variations 120x278

- R7EN 120x278 Glossy Rett
- R6RP 120x240 Glossy Rett
- R6RZ 120x120 Glossy Rett

## Grafite



Marble Effect variations 120x278

- R7GH 120x278 Rett
- R7EP 120x278 Glossy Rett
- R6RU 120x240 Rett
- R6RQ 120x240 Glossy Rett
- R6SF 120x120 Rett
- R6SO 120x120 Glossy Rett

# Maiora Marble

120x278 - 47<sup>1/4</sup> x 109<sup>7/16</sup> 120x240 - 47<sup>1/4</sup> x 94<sup>1/2</sup> 120x120 - 47<sup>1/4</sup> x 47<sup>1/4</sup> 34,5x30 - 13<sup>7/16</sup> x 11<sup>13/16</sup> 30x32,5 - 11<sup>13/16</sup> x 12<sup>13/16</sup> 30x30 - 11<sup>13/16</sup> x 11<sup>13/16</sup>

## Decors



**BINARIO** 34,5x30  
Calacatta Oro Glossy / Emperador Glossy



**DECORO** 30x32,5  
Grafite Glossy / Statuario Glossy

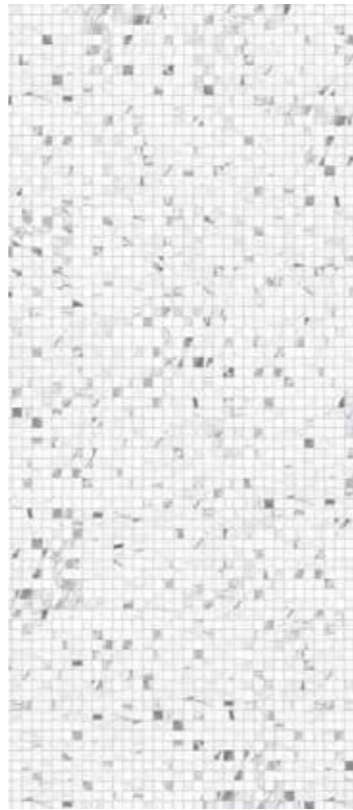

**ENIGMA** 30x30  
Paonazzetto / Paonazzetto Glossy

## TECH INFO

VARIAZIONI CROMATICHE / COLOUR VARIATIONS / FARBVARIATIONEN / VARIATIONEN CHROMATIQUES / VARIACIONES CROMÁTICAS / ВАРИАНТЫ ОТТЕНКА



Significativa variazione di aspetto superficiale, grafica e colore da piastrella a piastrella e all'interno della stessa piastrella. Si consiglia di visionare la gamma cromatica prima della selezione del materiale / Significant variation in texture, pattern and colour from tile to tile within the same production run. The colour range should be viewed before selecting the material / Bedeutende Variation in Aussehen, Struktur und Farbe von Fliese zu Fliese und in ein und derselben Fliese. Es wird empfohlen, das Farbsortiment vor der Auswahl des Materials zu prüfen / Variation significative au niveau de l'aspect, de la fantaisie et de la couleur entre les carreaux et au sein d'un même carreau. Il est recommandé de consulter la gamme des couleurs avant de sélectionner le matériel / Variación considerable en el aspecto superficial, los motivos y el color entre un azulejo y otro y dentro del propio azulejo. Es aconsejable visualizar la gama cromática antes de seleccionar el material / Значительные отличия вида поверхности, графики и цвета у разных плиток и на одной и той же плитке. Перед отбором материала рекомендуется посмотреть цветовую гамму

DESTINAZIONE D'USO / INTENDED USE / ANWENDUNGSBEREICH / CHAMP D'APPLICATION / USO PREVISTO / НАЗНАЧЕНИЕ

### G (Naturale/Matt)

Materiali consigliati per locali sottoposti a sollecitazioni all'abrasione medio pesanti come: case individuali, commerciale leggero / Materials recommended for premises with medium-heavy abrasion levels, such as: detached homes, light-traffic commercial premises / Empfohlen für Räume mit mittelschwerer Abriebbeanspruchung wie: Einfamilienhäuser, leicht beanspruchte Gewerbebereiche / Matériaux recommandés pour des locaux soumis à des contraintes d'abrasion moyennes et fortes comme : maisons particulières, espaces commerciaux soumis à un trafic léger, etc / Materiales recomendados para locales sometidos a esfuerzos de abrasión medio-pesados, como casas unifamiliares y locales comerciales de tráfico ligero / Материалы рекомендованы для использования в частных домах и коммерческих помещениях, подверженных средне-сильному абразивному воздействию

### F (Glossy)

Materiali consigliati per qualsiasi locale di un'abitazione che non abbia collegamenti diretti con l'esterno o accessi non protetti da zerbini. Medie sollecitazioni all'abrasione / Tiles suitable for any room of a house without direct access from the outside or access not protected by doormats. Mean stress abrasive wear / Für alle Räume des Wohnbereichs empfohlen, zu denen man keinen direkten Zutritt von außen hat oder welche nicht durch Fußteppiche abgegrenzt sind. Mittlere Abriebbeanspruchung / Matériaux conseillés pour toutes les pièces d'une maison qui n'a pas d'accès directs par l'extérieur ou non protégés par des paillasons. Abrasion sous contraintes moyennes / Materiales aconsejados para cualquier habitación de una vivienda sin accesos directos desde el exterior o accesos no protegidos por felpudos. Esfuerzos medianos por abrasión / Материалы рекомендованы для любых жилых помещений, не имеющих прямого выхода на улицу или же доступа без входных ковриков. Среднее абразивное воздействие

VARIAZIONI EFFETTO MARMO / MARBLE LOOK VARIATIONS / VARIATIONEN MARMOROPTIK / VARIATIONS EFFET MARBRE / VARIACIONES EFECTO MÁRMOL / ВАРИАНТЫ ЭФФЕКТА ПОД МРАМОМ

Le immagini riportate rappresentano tutte le diverse grafiche del prodotto che vengono realizzate in successione sulla linea di produzione per ogni codice. Il codice prodotto è univoco: non è quindi possibile scegliere le grafiche e garantire la presenza di tutte le facce nella preparazione del materiale / The images shown illustrate the different product patterns manufactured in succession on the production line for each article. Every product code is unique: therefore, it is not possible to choose the patterns or guarantee that every tile surface will be included when the material is prepared / Les images reproduisent les différentes textures graphiques du produit, réalisées l'une à la suite de l'autre sur la ligne de production pour chaque code. Le code produit est univoco : il n'est donc pas possible de choisir les textures graphiques et de garantir la présence de toutes les variantes dans la préparation du matériau / Die Bilder zeigen die unterschiedlichen Materialzeichnungen des Produktes, die in der Produktionslinie für jeden Code nacheinander hergestellt werden. Es handelt sich um einen einheitlichen Produktcode: Aus diesem Grund ist es nicht möglich, die Materialzeichnungen auszuwählen und bei der Vorbereitung des Materials zu gewährleisten, dass alle Oberflächen vorhanden sind / Las imágenes presentadas muestran los diversos diseños gráficos del producto que se fabrican en serie en la línea de producción en referencia a cada código. El código del producto es unívoco: esto significa que no se pueden elegir los diseños gráficos y garantizar la presencia de todas las caras en la preparación del material / На изображениях приводится все разнообразие графики изделий, которая выпускается на производственной линии в последовательности для каждого кода. Код изделия является единым, следовательно, нельзя выбрать графику и гарантировать наличие всех вариантов при подготовке материала

DECORI / DECORATIVE PIECES / DEKORE / DÉCORS / DECORACIONES / ДЕКОРЫ

### Binario, Decoro, Enigma

Produzione su richiesta / Production on request / Produktion auf Anfrage / Production sur demande / Producción bajo pedido / Изготовление по запросу

CARATTERISTICHE / CHARACTERISTICS / EIGENSCHAFTEN / CARACTERISTIQUES / DATOS / ХАРАКТЕРИСТИКИ

<b>R9</b> Naturale/Matt	<b>PENDULUM</b> classe 1 Naturale/Matt	<b>D-COF</b> > 0,42 Naturale/ Matt	<b>BCR</b> μ > 0,40 Naturale/ Matt
≤ 175 mm <sup>3</sup>			

CERTIFICAZIONI / CERTIFICATIONS / ZERTIFIZIERUNGEN / CERTIFICACIONES / СЕРТИФИКАЦИИ



IMBALLI / PACKAGING / VERPACKUNGEN / EMBALLAGES / EMBALAJES / УПАКОВКИ

	scatole / box / karton / boîte / caja / короб			pallet / pallet / palette / palette / pallet / поддон			
	□	M²	KG	□	M²	KG	± mm
120x120	2	2,88	44,00	20	57,60	880,06	6

Imballaggio INCANTO & MAIORA > vedi Appendice / Packaging > see Appendix / Verpackungen > siehe Anhang / Emballages > voir Annexe / Embalajes > véase Apéndice / Упаковки > смотри Приложение

MARBLE EFFECT

# Bistrot



R788 Paonazetto Glossy Rettificato 75x75 - 29 1/2" x 29 1/2"



## Bistrot

gres fine porcellanato colorato in massa - rettificato monocalibro / colorbody fine porcelain stoneware - rectified monocaliber / durchgefärbtes feinsteinzeug - rektifiziert, in einem werkmaß / grès cérame fin coloré dans la masse - rectifié monocalibre / gres porcelánico fino coloreado en toda la masa - retificado monocalibre / гомогенный мелкозернистый керамогранит - ректифицированный монокалиберный

21x18,2

gres porcellanato / porcelain stoneware / feinsteinzeug / grès cérame émaillé / gres porcelánico / керамогранит

gruppo Bla UNI EN 14411\_6



75x150 cm  
29 1/2" x 59 1/16"  
± 10,5 mm

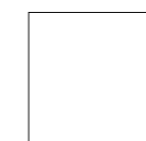

75x75 cm  
29 1/2" x 29 1/2"  
± 9,5 mm



60x60 cm  
23 5/8" x 23 5/8"  
± 9,5 - 10 mm



30x60 cm  
11 13/16" x 23 5/8"  
± 9,5 mm



21x18,2 cm  
8 1/4" x 7 3/16"  
± 9,5 mm

WALL TILES  
Bistrot Wall > p.504

# Bistrot

75x150 - 29<sup>1/2</sup> x 59<sup>1/8</sup>" 75x75 - 29<sup>1/2</sup> x 29<sup>1/2</sup>" 60x60 - 23<sup>5/8</sup> x 23<sup>5/8</sup>" 30x60 - 11<sup>13/16</sup> x 23<sup>5/8</sup>" 30x30 - 11<sup>13/16</sup> x 11<sup>13/16</sup>" 21x18,2 - 8<sup>1/4</sup> x 7<sup>3/16</sup>"

## Paonazzetto

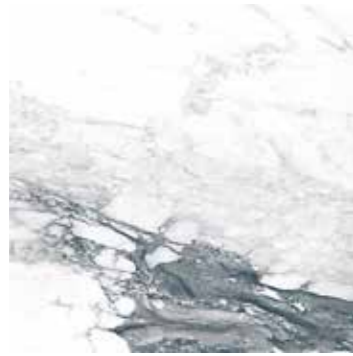

- R782 75x150 Rett
- R786 75x150 Glossy Rett
- R78A 75x75 Rett
- R788 75x75 Glossy Rett
- R7DC 60x60 Rett
- R7DE 60x60 Glossy Rett
- R7DG 30x60 Rett

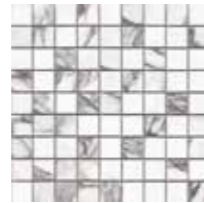

- R7QQ 30x30 Mosaico
- R7QN 30x30 Mosaico Glossy



- R7WU 30x30 Mosaico Trapezi Glossy



- R7QE 7x60 BT.B.C.
- R7QL 7x60 BT.B.C. Glossy



- R7QG 7x75 BT.B.C.
- R7QJ 7x75 BT.B.C. Glossy

## Arabescato



- R5WC 75x150 Soft Rett
- R5WL 75x150 Glossy Rett
- R5WG 75x75 Soft Rett
- R5WQ 75x75 Glossy Rett
- R5X3 60x60 Soft Rett
- R5WX 60x60 Glossy Rett
- R5X8 30x60 Soft Rett

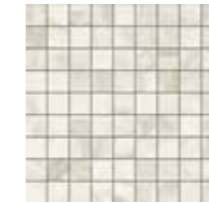

- R6SR 30x30 Mosaico Soft
- R6SV 30x30 Mosaico Glossy



- R6WC 7x60 BT.B.C.
- R6WK 7x60 BT.B.C. Glossy



- R6VF 7x75 BT.B.C.
- R6VS 7x75 BT.B.C. Glossy

## Pietrasanta



- R50A 75x150 Soft Rett
- R50H 75x150 Glossy Rett
- R4LF 75x75 Soft Rett
- R4LG 75x75 Glossy Rett
- R4MH 60x60 Soft Rett
- R4MJ 60x60 Glossy Rett
- R4SL 30x60 Soft Rett

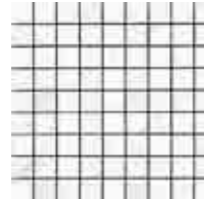

- R4ZL 30x30 Mosaico Soft



- R4VK 7x60 BT.B.C.
- R4VS 7x60 BT.B.C. Glossy



- R50V 7x75 BT.B.C.
- R51C 7x75 BT.B.C. Glossy

## Calacatta Michelangelo



- R50C 75x150 Soft Rett
- R50J 75x150 Glossy Rett
- R4RM 75x75 Soft Rett
- R4RJ 75x75 Glossy Rett
- R4MK 60x60 Soft Rett
- R4ML 60x60 Glossy Rett
- R4RY 30x60 Soft Rett



- R4ZM 30x30 Mosaico Soft



- R4VL 7x60 BT.B.C.
- R4VT 7x60 BT.B.C. Glossy



- R50W 7x75 BT.B.C.
- R51D 7x75 BT.B.C. Glossy

## Statuario



- R5WD 75x150 Soft Rett
- R5WM 75x150 Glossy Rett
- R5WH 75x75 Soft Rett
- R5WR 75x75 Glossy Rett
- R5X4 60x60 Soft Rett
- R5WY 60x60 Glossy Rett
- R5XA 30x60 Soft Rett

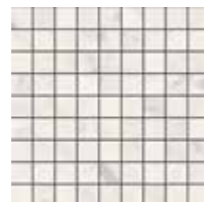

- R6SS 30x30 Mosaico Soft
- R6SW 30x30 Mosaico Glossy



- R6WE 7x60 BT.B.C.
- R6WM 7x60 BT.B.C. Glossy



- R6VH 7x75 BT.B.C.
- R6VU 7x75 BT.B.C. Glossy

## Crema Delicata



- R69Z 75x150 Soft Rett
- R69X 75x150 Glossy Rett
- RGA1 75x75 Soft Rett
- RGA3 75x75 Glossy Rett
- R69S 60x60 Soft Rett
- R69P 60x60 Glossy Rett
- RGA5 30x60 Soft Rett



- RKU7 30x30 Mosaico Brick Soft



- RGLD 7x60 BT.B.C.
- RGLH 7x60 BT.B.C. Glossy



- RGLF 7x75 BT.B.C.
- RGLK 7x75 BT.B.C. Glossy

# Bistrot

75x150 - 29<sup>1/2</sup> x 59<sup>1/16</sup> 75x75 - 29<sup>1/2</sup> x 29<sup>1/2</sup> 60x60 - 23<sup>5/8</sup> x 23<sup>5/8</sup> 30x60 - 11<sup>13/16</sup> x 23<sup>5/8</sup> 30x30 - 11<sup>13/16</sup> x 11<sup>13/16</sup> 21x18,2 - 8<sup>1/4</sup> x 7<sup>3/16</sup>

## Marfil



- R50D 75x150 Soft Rett
- R50K 75x150 Glossy Rett
- R4RN 75x75 Soft Rett
- R4RK 75x75 Glossy Rett
- R4MN 60x60 Soft Rett
- R4MM 60x60 Glossy Rett
- R4SM 30x60 Soft Rett

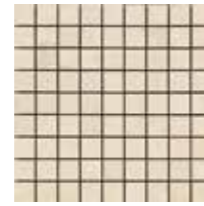

R4ZK 30x30 Mosaico Soft



- R4VM 7x60 BT.B.C.
- R4VU 7x60 BT.B.C. Glossy



- R50X 7x75 BT.B.C.
- R51E 7x75 BT.B.C. Glossy

## Augustus



- RG9Y 75x150 Soft Rett
- RG9W 75x150 Glossy Rett
- RG0A 75x75 Soft Rett
- RG02 75x75 Glossy Rett
- RG9R 60x60 Soft Rett
- RG9N 60x60 Glossy Rett
- RG04 30x60 Soft Rett



RKU5 30x30 Mosaico Brick Soft



- RGLC 7x60 BT.B.C.
- RGLG 7x60 BT.B.C. Glossy



- RGLE 7x75 BT.B.C.
- RGLJ 7x75 BT.B.C. Glossy

## Crux Taupe



- R50E 75x150 Soft Rett
- R50L 75x150 Glossy Rett
- R4UR 75x75 Soft Rett
- R4LQ 75x75 Glossy Rett
- R4UT 60x60 Soft Rett
- R4RR 60x60 Glossy Rett

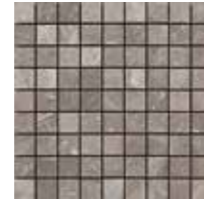

R4ZQ 30x30 Mosaico Soft



- R4VP 7x60 BT.B.C.
- R4VV 7x60 BT.B.C. Glossy



- R50Z 7x75 BT.B.C.
- R51F 7x75 BT.B.C. Glossy

## Grafite



- R5WF 75x150 Soft Rett
- R5WP 75x150 Glossy Rett
- R5WK 75x75 Soft Rett
- R5WT 75x75 Glossy Rett
- R5X6 60x60 Soft Rett
- R5X2 60x60 Glossy Rett
- R5XD 30x60 Soft Rett

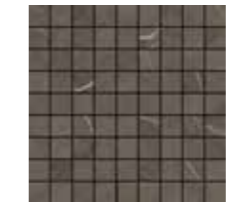

R6ST 30x30 Mosaico Soft  
R6SY 30x30 Mosaico Glossy



- R6WG 7x60 BT.B.C.
- R6WR 7x60 BT.B.C. Glossy



- R6VN 7x75 BT.B.C.
- R6VY 7x75 BT.B.C. Glossy

## Crux Grey



- R50F 75x150 Soft Rett
- R50M 75x150 Glossy Rett
- R50P 75x150 Strutt Rett
- R4US 75x75 Soft Rett
- R4LP 75x75 Glossy Rett
- R4UU 60x60 Soft Rett
- R4RS 60x60 Glossy Rett

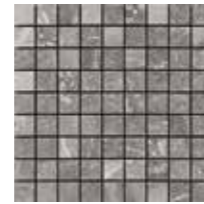

R4ZR 30x30 Mosaico Soft



- R4VQ 7x60 BT.B.C.
- R4VW 7x60 BT.B.C. Glossy



- R51A 7x75 BT.B.C.
- R51G 7x75 BT.B.C. Glossy

## Emperador



- R5WN 75x150 Glossy Rett
- R5WS 75x75 Glossy Rett
- R5WZ 60x60 Glossy Rett

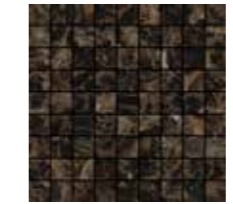

R6SX 30x30 Mosaico Glossy



- R6VP 7x60 BT.B.C. Glossy



- R6VW 7x75 BT.B.C. Glossy

# Bistrot

## Infinity



- R50G** 75x150 Soft Rett
- R50N** 75x150 Glossy Rett
- R50Q** 75x150 Strutt Rett
- R4RO** 75x75 Soft Rett
- R4RL** 75x75 Glossy Rett
- R4RU** 60x60 Soft Rett
- R4RT** 60x60 Glossy Rett
- R4SP** 30x60 Soft Rett

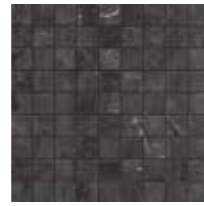

**R4ZS** 30x30 Mosaico Soft-



**R4SY** 7x28



- R4VR** 7x60 BT.B.C.
- R4VX** 7x60 BT.B.C. Glossy



- R50Y** 7x75 BT.B.C.
- R51H** 7x75 BT.B.C. Glossy



**R4SZ** 21x18,2 Pietrasanta



**R4TA** 21x18,2 Calacatta Michelangelo



**R4TC** 21x18,2 Marfil



**R4TE** 21x18,2 Crux Grey



**R4TD** 21x18,2 Crux Taupe



**R4TF** 21x18,2 Infinity

## Decors

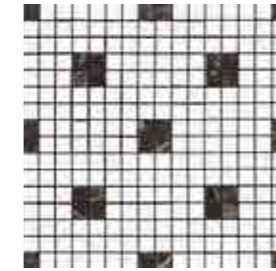

**R4ZH** 30x30 Pietrasanta Glossy

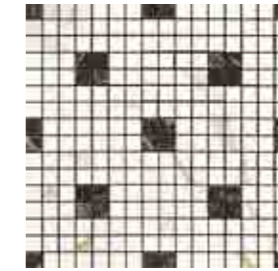

**R4ZJ** 30x30 Calacatta Michelangelo Glossy

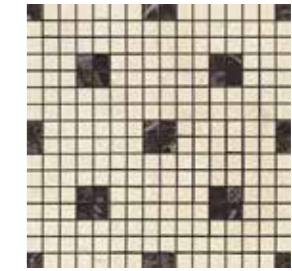

**R4ZN** 30x30 Marfil Glossy

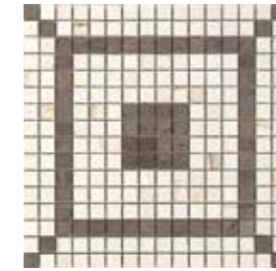

**RKU9** 30x30 Crema Delicata Glossy

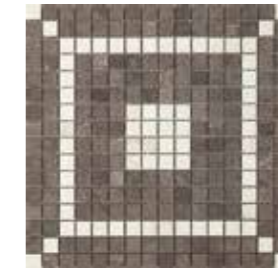

**RKU8** 30x30 Augustus Glossy



**R4YP** 21x18,2 Pietrasanta



**R4YQ** 21x18,2 Calacatta Michelangelo



**R4YR** 21x18,2 Marfil

75x150 - 29<sup>1/2</sup> x 59<sup>1/8</sup> 75x75 - 29<sup>1/2</sup> x 29<sup>1/2</sup> 60x60 - 23<sup>5/8</sup> x 23<sup>5/8</sup> 30x60 - 11<sup>13/16</sup> x 23<sup>5/8</sup> 30x30 - 11<sup>13/16</sup> x 11<sup>13/16</sup> 21x18,2 - 8<sup>1/4</sup> x 7<sup>3/16</sup>

TECH INFO

VARIAZIONI CROMATICHE / COLOUR VARIATIONS / FARBVARIATIONEN / VARIATIONS CHROMATIQUES / VARIACIONES CROMÁTICAS / ВАРИАНТЫ ОТТЕНКА

**V2 (Pietrasanta, Marfil, Augustus, Infinity)**

Apprezzabili differenze nell'aspetto di superficie e grafica all'interno della stessa produzione / Clearly distinguishable differences in texture and pattern within the same production run / Auffällige Unterschiede in Aussehen und Struktur innerhalb der gleichen Produktionscharge / Différences visibles au niveau de l'aspect et de la fantaisie entre les carreaux du même lot de production / Diferencias visibles en el aspecto de la superficie y los motivos dentro de un mismo lote de producción / заметные отличия вида поверхности и графики в одной и той же партии

**V3 (Paonazetto, Calacatta Michelangelo, Arabescato, Emperador, Grafite, Statuario, Crema Delicato)**

Significativa variazione di aspetto superficiale, grafica e colore da piastrella a piastrella e all'interno della stessa piastrella. Si consiglia di visionare la gamma cromatica prima della selezione del materiale / Significant variation in texture, pattern and colour from tile to tile within the same production run. The colour range should be viewed before selecting the material / Bedeutende Variation in Aussehen, Struktur und Farbe von Fliese zu Fliese und in ein und derselben Fliese. Es wird empfohlen, das Farbsortiment vor der Auswahl des Materials zu prüfen / Variation significative au niveau de l'aspect, de la fantaisie et de la couleur entre les carreaux et au sein d'un même carreau. Il est recommandé de consulter la gamme des couleurs avant de sélectionner le matériel / Variación considerable en el aspecto superficial, los motivos y el color entre un azulejo y otro y dentro del propio azulejo. Es aconsejable visualizar la gama cromática antes de seleccionar el material / Значительные отличия вида поверхности, графики и цвета у разных плиток и на одной и той же плитке. Перед отбором материала рекомендуется посмотреть цветовую гамму

**V4 (CruX Taupe, CruX Grey)**

Variazioni irregolari da piastrella a piastrella. Una piastrella può differire totalmente nell'aspetto superficiale e colore da un'altra. Si consiglia divisionare la gamma cromatica prima della selezione del materiale / Random differences from tile to tile. One tile may have totally different texture and colour from another. The colour range should be viewed before selecting the material / Wesentliche Variationen von Fliese zu Fliese. Eine Fliese kann sich in Aussehen und Farbe komplett von einer anderen unterscheiden. Es wird empfohlen, das Farbsortiment vor der Auswahl des Materials zu prüfen / Variations irrégulières entre les carreaux. L'aspect et la couleur peuvent être complètement différents d'un carreau à l'autre. Il est recommandé de consulter la gamme des couleurs avant de sélectionner le matériel / Variaciones irregulares entre un azulejo y otro. Un azulejo puede ser completamente diferente de otro en el aspecto superficial y el color. Es aconsejable visualizar la gama cromática antes de seleccionar el material / Неоднородные изменения на разных плитках. Каждая плитка может полностью отличаться по виду поверхности и цвету от другой. Перед отбором материала рекомендуется посмотреть цветовую гамму

DESTINAZIONE D'USO / INTENDED USE / ANWENDUNGSBEREICH / CHAMP D'APPLICATION / USO PREVISTO / НАЗНАЧЕНИЕ

**G (Soft)**

Materiali consigliati per locali sottoposti a sollecitazioni all'abrasione medio pesanti come: case individuali, commerciale leggero / Materials recommended for premises with medium-heavy abrasion levels, such as: detached homes, light-traffic commercial premises / Empfohlen für Räume mit mittelschwerer Abriebbeanspruchung wie: Einfamilienhäuser, leicht beanspruchte Gewerbebereiche / Matériaux recommandés pour des locaux soumis à des contraintes d'abrasion moyennes et fortes comme : maisons particulières, espaces commerciaux soumis à un trafic léger, etc / Materiales recomendados para locales sometidos a esfuerzos de abrasión medio-pesados, como casas unifamiliares y locales comerciales de tráfico ligero / Материалы рекомендованы для использования в частных домах и коммерческих помещениях, подверженных средне-сильному абразивному воздействию

**F (Glossy)**

Materiali consigliati per qualsiasi locale di un'abitazione che non abbia collegamenti diretti con l'esterno o accessi non protetti da zerbini. Medie sollecitazioni all'abrasione / Tiles suitable for any room of a house without direct access from the outside or access not protected by doormats. Mean stress abrasive wear / Für alle Räume des Wohnbereichs empfohlen, zu denen man keinen direkten Zutritt von außen hat oder welche nicht durch Fußteppiche abgegrenzt sind. Mittlere Abriebbeanspruchung / Matériaux conseillés pour toutes les pièces d'une maison qui n'a pas d'accès directs par l'extérieur ou non protégés par des paillassons. Abrasion sous contraintes moyennes / Materiales aconsejados para cualquier habitación de una vivienda sin accesos directos desde el exterior o accesos no protegidos por felpudos. Esfuerzos medianos por abrasión / Материалы рекомендованы для любых жилых помещений, не имеющих прямого выхода на улицу или же доступа без входных ковриков. Среднее абразивное воздействие

**H (Strutturato)**

Materiali consigliati per sollecitazioni all'abrasione relativamente forti in ambienti anche non protetti da agenti graffianti / Materials recommended for relatively heavy abrasion levels, also in premises not protected against abrasive substances / Materials recommended for relatively heavy abrasion levels, also in premises not protected against abrasive substances / Empfohlen für starke Abriebbeanspruchungen in Bereichen auch ohne Kratzschutzbehandlung / Matériaux recommandés pour des locaux soumis à des fortes contraintes d'abrasion, même non protégés contre les agents abrasifs / Materiales recomendados para soportar esfuerzos de abrasión relativamente intensos incluso en espacios no protegidos frente a agentes abrasivos / Материалы рекомендованы для относительно сильного абразивного воздействия, в том числе в помещениях, не защищенных от царапающих элементов

CONSIGLI DI POSA / INSTALLATION ADVICE / HINWEISE ZUR VERLEGUNG / CONSEILS DE POSE / SUGERENCIAS PARA LA COLOCACIÓN / РЕКОМЕНДАЦИИ ПО УКЛАДКЕ

Per le pavimentazioni esterne non protette, Ragno consiglia di creare una pendenza ≥ 1,5% sulla superficie calpestabile allo scopo di limitare il formarsi di ristagni d'acqua localizzati. Nel caso in cui questi ristagni permangano sulla superficie delle piastrelle nonostante una posa a regola d'arte, è necessario intervenire meccanicamente con l'utilizzo di scope o aspira-liquidi / For unprotected outdoor pavings, Ragno recommends the creation of a gradient of ≥ 1.5% on the finished surface, to prevent the formation of patches of standing water. In the event that standing water persists on the surface of the tiles in spite of correct installation, it must be removed mechanically with the aid of brooms or wet-and-dry vacuum cleaners / Zur Unterbindung von punktueller Stauwasserbildung bei Belägen in ungeschützten Außenbereichen, empfiehlt die Ragno die Ausbildung eines Gefälles ≥ 1,5% auf der Trittfäche. Sollte trotz fachgerechter Verlegung Stauwasser auf der Fliesenoberfläche zurückbleiben, ist dessen mechanische Entfernung mit Hilfe eines Besens oder Nasssaugers erforderlich / Pour des sols extérieurs non protégés, Ragno conseille de créer une inclinaison ≥ 1,5 % sur la surface de périmètre en vue de limiter la stagnation localisée de l'eau. Si, malgré une pose dans les règles de l'art, cette stagnation devait persister à la surface des carreaux, une intervention mécanique, au moyen de balais et d'aspirateurs de liquides, est alors nécessaire / En el caso de pavimentaciones exteriores no protegidas, Ragno recomienda crear una pendiente ≥ 1,5% en la superficie transitable para limitar la formación de depósitos localizados de agua estancada. En caso de que estos depósitos de agua permanezcan en la superficie del azulejo, aun cuando la colocación se haya realizado correctamente, será necesario intervenir mecánicamente empleando un cepillo o un aspirador de líquidos / Для наружных незащищенных полов Ragno рекомендует создавать уклон ≥ 1,5% на пешеходной поверхности для снижения образования локальных застоев воды. В случае, если застои воды образуются на плитке несмотря на правильную укладку, необходимо прибегать к использованию механических средств, таких как щетки или же аппараты для сбора жидкостей

DECORI / DECORATIVE PIECES / DEKORE / DÉCORS / DECORACIONES / ДЕКОРЫ

**Mosaico, Mosaico Brick, Mosaico trapezi**

Mosaico assemblato su rete in fibra di vetro / Mosaic mesh - mounted on fibreglass / Auf Glasfasernetz geklebtes Mosaik / Mosaïque montée sur filet en fibre de verre / Mosaico enmallado sobre fibra de vidrio / Мозаика, собранная на сетке из стекловолокон

**Mosaico (Arabescato, Grafite, Emperador)**



Mosaico assemblato con tratto plastico / Spot-bonded mosaic / Punktverklebtes Mosaik / Mosaïque montée avec trait de colle / Mosaico colocado aplicando cola plástica / Мозаика с сегментами, выполненными из пластмассы - Мозаика, собранная на клеевой точке

PEZZI SPECIALI / TRIMS / SPEZIALTEILE / PIÈCES SPÉCIALES / PIEZAS ESPECIALES / СПЕЦИАЛЬНЫЕ ИЗДЕЛИЯ

**BT.B.C.**

Battiscopa Becco Civetta ottenuto da taglio del fondo / Coved Edge Skirting Tile cut from plain tile / Sockelleiste, Halbrundstab, aus Grundfliese geschnitten / Plinthe bord rond découpée dans le fond / Rodapié canto romo conseguido mediante corte del fondo / Плинтус с закругленным краем, полученный из фоновой плитки

CARATTERISTICHE / CHARACTERISTICS / EIGENSCHAFTEN / CARACTERISTIQUES / DATOS / ХАРАКТЕРИСТИКИ

	<b>R9</b> Paonazetto Nat/Matt	<b>PENDULUM classe 1</b> Paonazetto Nat/Matt, 21x18,2	<b>D-COF &gt; 0,42</b>	<b>BCR μ &gt; 0,40</b>
	<b>R10</b> Strutturato			
	<b>B</b> Strutturato			
	<b>≤ 175 mm<sup>2</sup></b>			

CERTIFICAZIONI / CERTIFICATIONS / ZERTIFIZIERUNGEN / CERTIFICATIONS / CERTIFICACIONES / СЕРТИФИКАЦИИ



IMBALLI / PACKAGING / VERPACKUNGEN / EMBALAJES / УПАКОВКИ

		scatole / box / karton / boîte / caja / короб			pallet / pallet / palette / palette / pallet / поддон			
		□	M²	KG	□	M²	KG	± mm
75x150	Paonazetto, Soft, Strutt	2	2,25	55,16	21	47,25	1158,37	10,5
75x150	Glossy	2	2,25	55,89	21	47,25	1173,62	10,5
75x75		2	1,13	23,81	42	47,25	1000,00	9,5
60x60	Paonazetto, Soft	3	1,08	22,67	40	43,20	906,99	9,5
60x60	Glossy	3	1,08	26,21	40	43,20	1048,54	10
30x60	Paonazetto, Soft	6	1,08	21,51	48	51,84	1032,26	9,5
21x18,2		16	0,46	9,30	100	45,86	930,33	9,5
30x30	Mosaico Paonazetto, Soft	4	0,36	7,50	-	-	-	9,5
30x30	Mosaico Glossy	4	0,36	7,50	-	-	-	10
30x30	Mosaico Trapezi Glossy	4	0,36	7,00	-	-	-	10
30x30	Mosaico Brick Soft	4	0,36	10,00	-	-	-	9,5
21x18,2	Decoro	16	0,46	9,52	100	45,86	952,85	9,5
7x60	BT.B.C. Paonazetto, Soft	15	9,00 ml	14,43	-	-	-	9,5
7x60	BT.B.C. Glossy	14	8,40 ml	14,88	-	-	-	10
7x75	BT.B.C. Paonazetto	14	10,5 ml	20,00	-	-	-	9,5
7x75	BT.B.C. Soft	13	9,75 ml	17,45	-	-	-	9,5
7x75	BT.B.C. Glossy	14	10,5 ml	18,57	-	-	-	9,5



MARBLE EFFECT

# Imperiale



R732 Travertino Grigio Glossy Rettificato 58x58 - 22<sup>13/16</sup>" x 22<sup>13/16</sup>"



## Imperiale

gres porcellanato - rettificato monocalibro / porcelain stoneware - rectified monocaliber / feinsteinzeug - rektifiziert, in einem werkmaß / grès cérame émaillé - rectifié monocalibre / gres porcelánico - rectificado monocalibre / керамогранит - ректифицированный монокалиберный

gruppo Bla UNI EN 14411\_G



naturale/ glossy  
matt



60x120 cm  
23<sup>5/8</sup>" x 47<sup>1/4</sup>"  
± 9,5 mm



58x116 cm  
22<sup>13/16</sup>" x 45<sup>1/16</sup>"  
± 9,5 mm

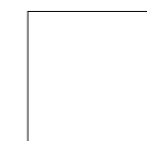

60x60 cm  
23<sup>5/8</sup>" x 23<sup>5/8</sup>"  
± 9,5 mm

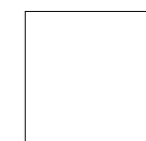

58x58 cm  
22<sup>13/16</sup>" x 22<sup>13/16</sup>"  
± 9,5 mm

WALL TILES  
Imperiale Wall > p.524

# Imperiale

60x120 - 23<sup>5/8</sup> x 47<sup>1/4</sup> 58x116 - 22<sup>13/16</sup> x 45<sup>11/16</sup> 60x60 - 23<sup>5/8</sup> x 23<sup>5/8</sup> 58x58 - 22<sup>13/16</sup> x 22<sup>13/16</sup>

## Bianco



**R72P** 60x120 Rett  
**R70Z** 58x116 Glossy Rett  
**R738** 60x60 Rett  
**R72W** 58x58 Glossy Rett



**R73J** 7x58 BT.B.C. Glossy  
**R742** 7x60 BT.B.C.

## Calacatta



**R72H** 58x116 Glossy Rett  
**R73C** 60x60 Rett  
**R72Z** 58x58 Glossy Rett



**R73M** 7x58 BT.B.C. Glossy  
**R745** 7x60 BT.B.C.

## Venato



**R72Q** 60x120 Rett  
**R710** 58x116 Glossy Rett  
**R739** 60x60 Rett  
**R72X** 58x58 Glossy Rett



**R73K** 7x58 BT.B.C. Glossy  
**R743** 7x60 BT.B.C.

## Avorio



**R72S** 60x120 Rett  
**R72J** 58x116 Glossy Rett  
**R73D** 60x60 Rett  
**R730** 58x58 Glossy Rett



**R73N** 7x58 BT.B.C. Glossy  
**R746** 7x60 BT.B.C.

## Statuarietto

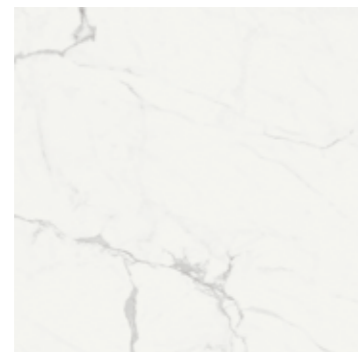

**R72R** 60x120 Rett  
**R726** 58x116 Glossy Rett  
**R73A** 60x60 Rett  
**R72Y** 58x58 Glossy Rett



**R73L** 7x58 BT.B.C. Glossy  
**R744** 7x60 BT.B.C.

## Travertino

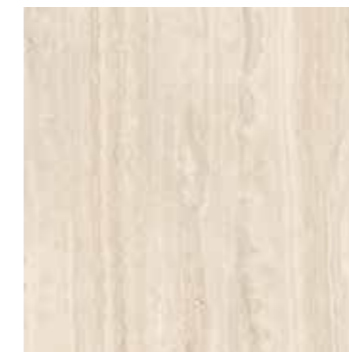

**R72K** 58x116 Glossy Rett  
**R73E** 60x60 Rett  
**R731** 58x58 Glossy Rett



**R73P** 7x58 BT.B.C. Glossy  
**R748** 7x60 BT.B.C.

# Imperiale

60x120 - 23<sup>5/8</sup>"x47<sup>1/4</sup>" 58x116 - 22<sup>13/16</sup>"x45<sup>1/8</sup>" 60x60 - 23<sup>5/8</sup>"x23<sup>5/8</sup>" 58x58 - 22<sup>13/16</sup>"x22<sup>13/16</sup>"

## Travertino Grigio



**R72T** 60x120 Rett  
**R72L** 58x116 Glossy Rett  
**R73F** 60x60 Rett  
**R732** 58x58 Glossy Rett



**R730** 7x58 BT.B.C. Glossy  
**R749** 7x60 BT.B.C.

## Crema



**R72U** 60x120 Rett  
**R72M** 58x116 Glossy Rett  
**R73G** 60x60 Rett  
**R734** 58x58 Glossy Rett



**R73R** 7x58 BT.B.C. Glossy  
**R74A** 7x60 BT.B.C.

## TECH INFO

VARIAZIONI CROMATICHE / COLOUR VARIATIONS / FARBVARIATIONEN / VARIATIONS CHROMATIQUES / VARIACIONES CROMÁTICAS / ВАРИАНТЫ ОТТЕНКА



**V2**

Apprezzabili differenze nell'aspetto di superficie e grafica all'interno della stessa produzione / Clearly distinguishable differences in texture and pattern within the same production run / Auffällige Unterschiede in Aussehen und Struktur innerhalb der gleichen Produktionscharge / Différences visibles au niveau de l'aspect et de la fantaisie entre les carreaux du même lot de production / Diferencias visibles en el aspecto de la superficie y los motivos dentro de un mismo lote de producción / заметные отличия вида поверхности и графики в одной и той же партии

DESTINAZIONE D'USO / INTENDED USE / ANWENDUNGSBEREICH / CHAMP D'APPLICATION / USO PREVISTO / НАЗНАЧЕНИЕ

### F (Glossy)

Materiali consigliati per qualsiasi locale di un'abitazione che non abbia collegamenti diretti con l'esterno o accessi non protetti da zerbini. Medie sollecitazioni all'abrasione / Tiles suitable for any room of a house without direct access from the outside or access not protected by doormats. Mean stress abrasive wear / Für alle Räume des Wohnbereichs empfohlen, zu denen man keinen direkten Zutritt von außen hat oder welche nicht durch Fußteppiche abgegrenzt sind. Mittlere Abriebbeanspruchung / Matériaux conseillés pour toutes les pièces d'une maison qui n'a pas d'accès directs par l'extérieur ou non protégés par des paillassons. Abrasion sous contraintes moyennes / Materiales aconsejados para cualquier habitación de una vivienda sin accesos directos desde el exterior o accesos no protegidos por felpudos. Esfuerzos medianos por abrasión / Материалы рекомендованы для любых жилых помещений, не имеющих прямого выхода на улицу или же доступа без входных ковриков. Среднее абразивное воздействие

### H (Naturale/Matt)

Materiali consigliati per sollecitazioni all'abrasione relativamente forti in ambienti anche non protetti da agenti graffianti / Materials recommended for relatively heavy abrasion levels, also in premises not protected against abrasive substances / Materials recommended for relatively heavy abrasion levels, also in premises not protected against abrasive substances / Empfohlen für starke Abriebbeanspruchungen in Bereichen auch ohne Kratzschutzbehandlung / Matériaux recommandés pour des locaux soumis à des fortes contraintes d'abrasion, même non protégés contre les agents abrasifs / Materiales recomendados para soportar esfuerzos de abrasión relativamente intensos incluso en espacios no protegidos frente a agentes abrasivos / Материалы рекомендованы для относительно сильного абразивного воздействия, в том числе в помещениях, не защищенных от царапающих элементов

PEZZI SPECIALI / TRIMS / SPEZIALTEILE / PIÈCES SPÉCIALES / PIEZAS ESPECIALES / СПЕЦИАЛЬНЫЕ ИЗДЕЛИЯ

### BT.B.C.

Battiscopa Becco Civetta ottenuto da taglio del fondo / Coved Edge Skirting Tile cut from plain tile / Sockelleiste, Halbrundstab, aus Grundfliese geschnitten / Plinthe bord rond découpée dans le fond / Rodapié canto romo conseguido mediante corte del fondo / Плинтус с закругленным краем, полученный из фоновой плитки

CARATTERISTICHE / CHARACTERISTICS / EIGENSCHAFTEN / CARACTERISTIQUES / DATOS / ХАРАКТЕРИСТИКИ

 ≤ 175 mm<sup>2</sup>

CERTIFICAZIONI / CERTIFICATIONS / ZERTIFIZIERUNGEN / CERTIFICACIONES / СЕРТИФИКАЦИИ



IMBALLI / PACKAGING / VERPACKUNGEN / EMBALAJES / УПАКОВКИ

		scatole / box / karton / boîte / caja / короб			pallet / pallet / palette / palette / pallet / поддон			
		□	M <sup>2</sup>	KG	□	M <sup>2</sup>	KG	± mm
60x120	Rettificato	2	1,44	31,47	36	51,84	1132,85	9,5
58x116	Glossy Rettificato	2	1,35	31,28	36	48,44	1126,00	9,5
60x60	Rettificato	3	1,08	23,31	40	43,20	932,44	9,5
58x58	Glossy Rettificato	3	1,01	21,71	40	40,37	868,69	9,5
7x58	BT.B.C. Glossy	15	8,70 ml	15,57	-	-	-	9,5
7x60	BT.B.C.	15	9,00 ml	15,00	-	-	-	9,5

# STONE EFFECT



- 134 Realstone\_Argent
- 138 Realstone\_Lunar
- 144 Realstone\_Navigli
- 148 Realstone\_PietrAntica
- 154 Realstone\_Slate
- 160 Realstone\_Rain
- 166 Realstone\_Cardoso
- 170 Realstone\_Jerusalem
- 176 Realstone\_Quarzite
- 182 Stoneway\_Ardesia
- 188 Stoneway\_Barge Antica
- 194 Stoneway\_Porfido

STONE EFFECT

# Realstone\_Argent



R8SR Avorio 60x120 - 23<sup>5/8</sup>"x47<sup>1/4</sup>"



## Realstone\_Argent

gres fine porcellanato colorato in massa - rettificato monocalibro / colorbody fine porcelain stoneware - rectified monocaliber / durchgefärbtes feinsteinzeug - rektifiziert, in einem werkmaß / grès cérame fin coloré dans la masse - rectifié monocalibre / gres porcelánico fino coloreado en toda la masa - rectificado monocalibre / гомогенный мелкозернистый керамогранит - ректифицированный монокалиберный

gruppo Bla UNI EN 14411\_G

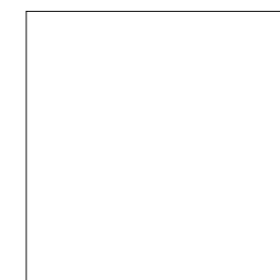
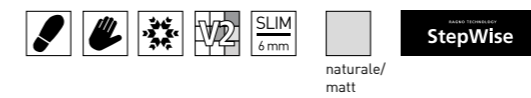

120x120 cm  
47<sup>1/4</sup>"x47<sup>1/4</sup>"  
± 6 mm



60x120 cm  
23<sup>5/8</sup>"x47<sup>1/4</sup>"  
± 6 mm

# Realstone\_Argent

120x120 - 47<sup>1/4</sup>"x47<sup>1/4</sup>" 60x120 - 23<sup>3/8</sup>"x47<sup>1/4</sup>"

## Avorio



**R8SN** 120x120 Rett  
**R8SR** 60x120 Rett

## Sabbia



**R8SP** 120x120 Rett  
**R8SS** 60x120 Rett

## TECH INFO

VARIAZIONI CROMATICHE / COLOUR VARIATIONS / FARBVARIATIONEN / VARIATIONS CHROMATIQUES / VARIACIONES CROMÁTICAS / ВАРИАНТЫ ОТТЕНКА



Apprezzabili differenze nell'aspetto di superficie e grafica all'interno della stessa produzione / Clearly distinguishable differences in texture and pattern within the same production run / Auffällige Unterschiede in Aussehen und Struktur innerhalb der gleichen Produktionscharge / Différences visibles au niveau de l'aspect et de la fantaisie entre les carreaux du même lot de production / Diferencias visibles en el aspecto de la superficie y los motivos dentro de un mismo lote de producción / заметные отличия вида поверхности и графики в одной и той же партии

DESTINAZIONE D'USO / INTENDED USE / ANWENDUNGSBEREICH / CHAMP D'APPLICATION / USO PREVISTO / НАЗНАЧЕНИЕ

### H (Naturale/Matt)

Materiali consigliati per sollecitazioni all'abrasione relativamente forti in ambienti anche non protetti da agenti graffianti / Materials recommended for relatively heavy abrasion levels, also in premises not protected against abrasive substances / Materials recommended for relatively heavy abrasion levels, also in premises not protected against abrasive substances / Empfohlen für starke Abriebbeanspruchungen in Bereichen auch ohne Kratzschutzbehandlung / Matériaux recommandés pour des locaux soumis à des fortes contraintes d'abrasion, même non protégés contre les agents abrasifs / Materiales recomendados para soportar esfuerzos de abrasión relativamente intensos incluso en espacios no protegidos frente a agentes abrasivos / Материалы рекомендованы для относительно сильного абразивного воздействия, в том числе в помещениях, не защищенных от царапающих элементов

TECNOLOGIE / TECHNOLOGIES / TECHNOLOGIEN / TECHNOLOGIES / TECNOLOGÍAS / ТЕХНОЛОГИИ

### StepWise

Le piastrelle realizzate con questa nuova tecnologia sono caratterizzate da un'elevata resistenza allo scivolamento e da una superficie morbida al tatto e facile da pulire, data l'assenza di ruvidità superficiale / The tiles produced using this new technology have a high degree of slip resistance and a surface which is soft to the touch and easy to clean, since it has no superficial roughness / Les carreaux utilisant cette nouvelle technologie de production se distinguent par une très grande résistance à la glissance et par une surface douce au toucher et facile à nettoyer puisqu'elle ne présente aucune rugosité / Mit dieser neuen Technologie hergestellte Fliesen zeichnen sich durch eine hohe Rutschhemmung, eine weiche Haptik und eine einfache Reinigung aufgrund der fehlenden Oberflächenrauheit aus / Los azulejos fabricados aplicando esta nueva tecnología se caracterizan por su elevada resistencia al deslizamiento y por presentar una superficie suave al tacto y fácil de limpiar, dada la nula aspereza de su superficie / Произведенная по этой новой технологии плитка обладает высокой стойкостью к скольжению и мягкой на ощупь, легко очищающейся поверхностью, что обеспечивается отсутствием шероховатости на поверхности

CARATTERISTICHE / CHARACTERISTICS / EIGENSCHAFTEN / CARACTERISTIQUES / DATOS / ХАРАКТЕРИСТИКИ

	<b>R10</b>	<b>PENDULUM classe 1</b>	<b>D-COF &gt; 0,42</b>	<b>BCR μ &gt; 0,40</b>
	<b>A Naturale/Matt</b>			
	<b>≤ 175 mm²</b>			

CERTIFICAZIONI / CERTIFICATIONS / ZERTIFIZIERUNGEN / CERTIFICACIONES / СЕРТИФИКАЦИИ



IMBALLI / PACKAGING / VERPACKUNGEN / EMBALLAGES / EMBALAJES / УПАКОВКИ

		scatole / box / karton / boîte / caja / коробк			pallet / pallet / palette / palette / pallet / поддон			
		□	M²	KG	□	M²	KG	± mm
120x120	Rettificato	2	2,88	46,00	20	57,60	919,98	6
60x120	Rettificato	3	2,16	30,08	15	32,40	451,19	6

STONE EFFECT

# Realstone\_Lunar



R7CN Silver Strutturato Rettificato 60x120 - 23<sup>5/8</sup>"x47<sup>1/4</sup>" - R7AK Uniform Rettificato 75x150 - 29<sup>1/2</sup>"x59<sup>1/8</sup>" - R7AR Uniform Rettificato 75x75 - 29<sup>1/2</sup>"x29<sup>1/2</sup>"

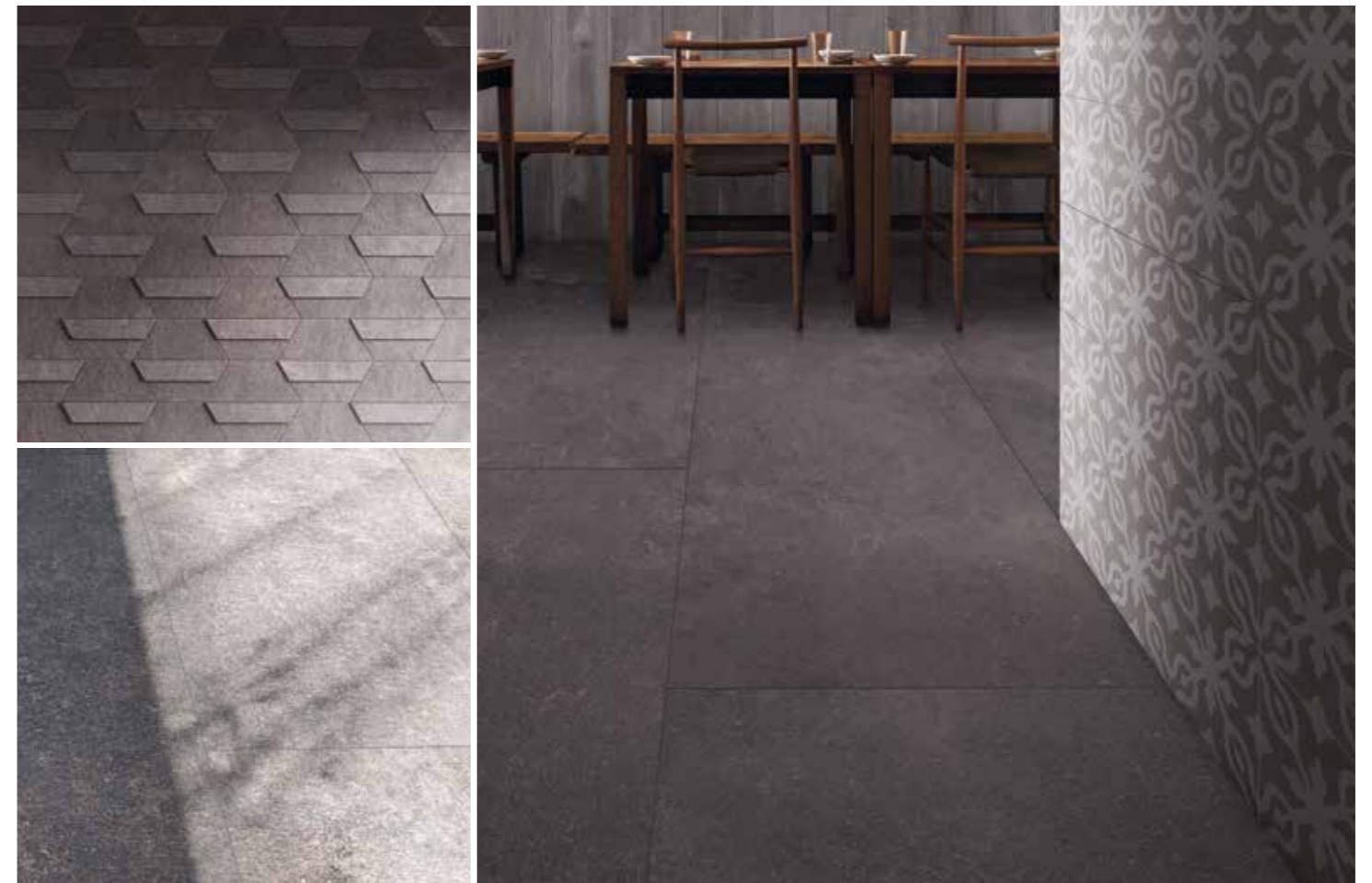

## Realstone\_Lunar

gres fine porcellanato colorato in massa - rettificato monocalibro / colorbody fine porcelain stoneware - rectified monocaliber / durchgefärbtes feinsteinzeug - rektifiziert, in einem werkmaß / grès cérame fin coloré dans la masse - rectifié monocalibre / gres porcelánico fino coloreado en toda la masa - retificado monocalibre / гомогенный мелкозернистый керамогранит - ректифицированный монокалиберный

gruppo Bia UNI EN 14411\_G



naturale/  
matt outdoor

<b>120x120 cm</b> 47 <sup>1/4</sup> "x47 <sup>1/4</sup> "	<b>75x150 cm</b> 29 <sup>1/2</sup> "x59 <sup>1/8</sup> "	<b>75x75 cm</b> 29 <sup>1/2</sup> "x29 <sup>1/2</sup> "	<b>60x120 cm</b> 23 <sup>5/8</sup> "x47 <sup>1/4</sup> "	<b>60x60 cm</b> 23 <sup>5/8</sup> "x23 <sup>5/8</sup> "	<b>30x60 cm</b> 11 <sup>13/16</sup> "x23 <sup>5/8</sup> "
± 10 mm	± 9,5 mm	± 9,5 mm	± 9,5 mm	± 9,5 mm	± 9,5 mm

**XT20**  
Realstone\_Lunar XT20  
> p.390

# Realstone\_Lunar

120x120 - 47<sup>1/4</sup> x 47<sup>1/4</sup> 75x150 - 29<sup>1/2</sup> x 59<sup>1/8</sup> 75x75 - 29<sup>1/2</sup> x 29<sup>1/2</sup> 60x120 - 23<sup>5/8</sup> x 47<sup>1/4</sup> 60x60 - 23<sup>5/8</sup> x 23<sup>5/8</sup> 30x60 - 11<sup>13/16</sup> x 23<sup>5/8</sup> 30x30 - 11<sup>13/16</sup> x 11<sup>13/16</sup> 29x33,5 - 11<sup>7/16</sup> x 13<sup>3/16</sup>

## White



**R8DH** 120x120 Rett  
**R7AH** 75x150 Rett  
**R7AP** 75x75 Rett  
**R7AV** 60x120 Rett  
**R7CQ** 60x120 Strutt Rett  
**R7CC** 60x60 Rett  
**R7CJ** 30x60 Rett  
**R7CW** 30x60 Strutt Rett



**R7NG** 30x30 Mosaico



**R7NN** 7x60 BT.B.C.  
**R7NZ** 7x75 BT.B.C.



**R7PG** 15x60x4 E.ELLE Strutt  
**R7PP** 15x120x4 E.ELLE Strutt

## Deep Grey



**R8DK** 120x120 Rett  
**R7AG** 75x150 Rett  
**R7AN** 75x75 Rett  
**R7AU** 60x120 Rett  
**R7CP** 60x120 Strutt Rett  
**R7CA** 60x60 Rett  
**R7CH** 30x60 Rett  
**R7CV** 30x60 Strutt Rett

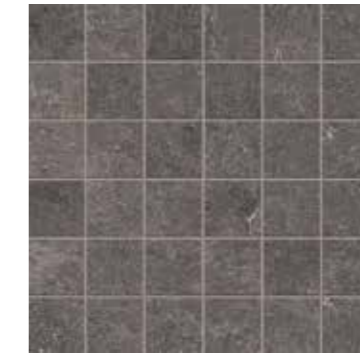

**R7NK** 30x30 Mosaico



**R7NU** 7x60 BT.B.C.  
**R7PC** 7x75 BT.B.C.



**R7PK** 15x60x4 E.ELLE Strutt  
**R7PU** 15x120x4 E.ELLE Strutt

## Beige



**R8DM** 120x120 Rett  
**R7AJ** 75x150 Rett  
**R7AQ** 75x75 Rett  
**R7AW** 60x120 Rett  
**R7CR** 60x120 Strutt Rett  
**R7CD** 60x60 Rett  
**R7CK** 30x60 Rett  
**R7CX** 30x60 Strutt Rett



**R7NH** 30x30 Mosaico



**R7NP** 7x60 BT.B.C.  
**R7P1** 7x75 BT.B.C.



**R7PH** 15x60x4 E.ELLE Strutt  
**R7PR** 15x120x4 E.ELLE Strutt

## Uniform

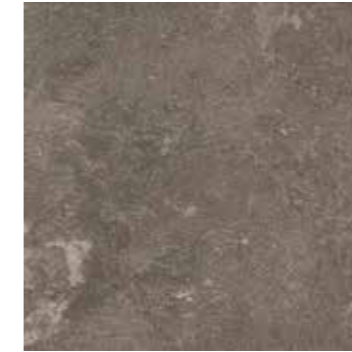

**R8DL** 120x120 Rett  
**R7AK** 75x150 Rett  
**R7AR** 75x75 Rett  
**R7AX** 60x120 Rett  
**R7CS** 60x120 Strutt Rett  
**R7CE** 60x60 Rett  
**R7CL** 30x60 Rett  
**R7CY** 30x60 Strutt Rett



**R7NL** 30x30 Mosaico



**R7NV** 7x60 BT.B.C.  
**R7PD** 7x75 BT.B.C.



**R7PL** 15x60x4 E.ELLE Strutt  
**R7PV** 15x120x4 E.ELLE Strutt

## Silver



**R8DJ** 120x120 Rett  
**R7AF** 75x150 Rett  
**R7AM** 75x75 Rett  
**R7AT** 60x120 Rett  
**R7CN** 60x120 Strutt Rett  
**R7AZ** 60x60 Rett  
**R7CG** 30x60 Rett  
**R7CU** 30x60 Strutt Rett



**R7NJ** 30x30 Mosaico



**R7NR** 7x60 BT.B.C.  
**R7PA** 7x75 BT.B.C.



**R7PJ** 15x60x4 E.ELLE Strutt  
**R7PS** 15x120x4 E.ELLE Strutt



# Realstone\_Lunar

120x120 - 47<sup>1/4</sup>"x47<sup>1/4</sup>" 75x150 - 29<sup>1/2</sup>"x59<sup>1/8</sup>"  
 75x75 - 29<sup>1/2</sup>"x29<sup>1/2</sup>" 60x120 - 23<sup>5/8</sup>"x47<sup>1/4</sup>" 60x60 - 23<sup>5/8</sup>"x23<sup>5/8</sup>" 30x60 - 11<sup>13/16</sup>"x23<sup>5/8</sup>" 30x30 - 11<sup>13/16</sup>"x11<sup>13/16</sup>" 29x33,5 - 11<sup>7/16</sup>"x13<sup>3/16</sup>"

## Decors



R7XK 29x33,5 Mosaico 3D White



R7XL 29x33,5 Mosaico 3D Beige



R7XM 29x33,5 Mosaico 3D Silver



R7XN 29x33,5 Mosaico 3D Deep Grey



R7XQ 29x33,5 Mosaico 3D Uniform

## TECH INFO

VARIAZIONI CROMATICHE / COLOUR VARIATIONS / FARBVARIATIONEN / VARIATIONS CHROMATIQUES / VARIACIONES CROMÁTICAS / ВАРИАНТЫ ОТТЕНКА



Apprezzabili differenze nell'aspetto di superficie e grafica all'interno della stessa produzione / Clearly distinguishable differences in texture and pattern within the same production run / Auffällige Unterschiede in Aussehen und Struktur innerhalb der gleichen Produktionscharge / Différences visibles au niveau de l'aspect et de la fantaisie entre les carreaux du même lot de production / Diferencias visibles en el aspecto de la superficie y los motivos dentro de un mismo lote de producción / заметные отличия вида поверхности и графики в одной и той же партии

DESTINAZIONE D'USO / INTENDED USE / ANWENDUNGSBEREICH / CHAMP D'APPLICATION / USO PREVISTO / НАЗНАЧЕНИЕ

### H (Naturale/Matt, Strutturato)

Materiali consigliati per sollecitazioni all'abrasione relativamente forti in ambienti anche non protetti da agenti graffianti / Materials recommended for relatively heavy abrasion levels, also in premises not protected against abrasive substances / Materials recommended for relatively heavy abrasion levels, also in premises not protected against abrasive substances / Empfohlen für starke Abriebbeanspruchungen in Bereichen auch ohne Kratzschutzbehandlung / Matériaux recommandés pour des locaux soumis à des fortes contraintes d'abrasion, même non protégés contre les agents abrasifs / Materiales recomendados para soportar esfuerzos de abrasión relativamente intensos incluso en espacios no protegidos frente a agentes abrasivos / Материалы рекомендованы для относительно сильного абразивного воздействия, в том числе в помещениях, не защищенных от царапающих элементов

DECORI / DECORATIVE PIECES / DEKORE / DÉCORS / DECORACIONES / ДЕКОРЫ

### Mosaico

Mosaico assemblato su rete in fibra di vetro / Mosaic mesh - mounted on fibreglass / Auf Glasfasernetz geklebtes Mosaik / Mosaïque montée sur filet en fibre de verre / Mosaico enmallado sobre fibra de vidrio / Мозаика, собранная на сетке из стекловолокна

### Mosaico 3D

Mosaico assemblato con tratto plastico / Spot-bonded mosaic / Punktverklebtes Mosaik / Mosaïque montée avec trait de colle / Mosaico colocado aplicando cola plástica / Мозаика с сегментами, выполненными из пластмассы - Мозаика, собранная на клеевой точке

PEZZI SPECIALI / TRIMS / SPEZIALTEILE / PIÈCES SPÉCIALES / PIEZAS ESPECIALES / СПЕЦИАЛЬНЫЕ ИЗДЕЛИЯ

### BT.B.C.

Battiscopa Becco Civetta ottenuto da taglio del fondo / Coved Edge Skirting Tile cut from plain tile / Sockelleiste, Halbrundstab, aus Grundfliese geschnitten / Plinthe bord rond découpée dans le fond / Rodapié canto romo conseguido mediante corte del fondo / Плинтус с закругленным краем, полученный из фоновой плитки

### E.Elle

Elemento ad Elle tagliato ed assemblato / Two-piece L-Tile / Schenkelplatte, geschnitten und zusammengesetzt / Élément en L coupé et assemblé / Elemento en forma de "L" cortado y montado / Г-образный элемент, состоящий из двух частей

TECNOLOGIE / TECHNOLOGIES / TECHNOLOGIEN / TECHNOLOGIES / TECNOLOGÍAS / ТЕХНОЛОГИИ

### StepWise

Le piastrelle realizzate con questa nuova tecnologia sono caratterizzate da un'elevata resistenza allo scivolamento e da una superficie morbida al tatto e facile da pulire, data l'assenza di ruvidità superficiale / The tiles produced using this new technology have a high degree of slip resistance and a surface which is soft to the touch and easy to clean, since it has no superficial roughness / Les carreaux utilisant cette nouvelle technologie de production se distinguent par une très grande résistance à la glissance et par une surface douce au toucher et facile à nettoyer puisqu'elle ne présente aucune rugosité / Mit dieser neuen Technologie hergestellte Fliesen zeichnen sich durch eine hohe Rutschhemmung, eine weiche Haptik und eine einfache Reinigung aufgrund der fehlenden Oberflächenrauheit aus / Los azulejos fabricados aplicando esta nueva tecnología se caracterizan por su elevada resistencia al deslizamiento y por presentar una superficie suave al tacto y fácil de limpiar, dada la nula aspereza de su superficie / Произведенная по этой новой технологии плитка обладает высокой стойкостью к скольжению и мягкой на ощупь, легко очищающейся поверхностью, что обеспечивается отсутствием шероховатости на поверхности

CARATTERISTICHE / CHARACTERISTICS / EIGENSCHAFTEN / CARACTERISTIQUES / DATOS / ХАРАКТЕРИСТИКИ

	R10 Naturale/Matt R11 Strutturato	PENDULUM classe 2 Naturale/Matt classe 3 Strutturato ptv > 36	D-COF > 0,42	BCR μ > 0,40
	B Naturale/Matt C Strutturato			
	≤ 175 mm <sup>3</sup>			

CERTIFICAZIONI / CERTIFICATIONS / ZERTIFIZIERUNGEN / CERTIFICACIONES / СЕРТИФИКАЦИИ



IMBALLI / PACKAGING / VERPACKUNGEN / EMBALLAGES / EMBALAJES / УПАКОВКИ

		scatole / box / karton / boîte / caja / коробк			pallet / pallet / palette / palette / pallet / поддон			
		□	M <sup>2</sup>	KG	□	M <sup>2</sup>	KG	± mm
120x120	Rettificato	1	1,44	37,99	36	51,84	1367,80	10
75x150	Rettificato	2	2,25	51,81	21	47,25	1088,00	9,5
75x75	Rettificato	2	1,13	23,81	42	47,25	1000,00	9,5
60x120	Rettificato, Strutturato	2	1,44	31,47	36	51,84	1132,85	9,5
60x60	Rettificato	3	1,08	22,50	40	43,20	900,00	9,5
30x60	Rettificato, Strutturato	6	1,08	23,04	48	51,84	1105,80	9,5
30x30	Mosaico	4	0,36	7,91	60	21,60	480,00	9,5
29x33,5	Mosaico 3D	4	0,21	10,00	48	10,20	480,00	9,5
7x60	BT.B.C.	14	8,40 ml	12,00	-	-	-	9,5
7x75	BT.B.C.	14	10,50 ml	20,00	-	-	-	9,5
15x60x4	E.ELLE	4	0,36	7,00	-	-	-	-
15x120x4	E.ELLE	2	0,36	20,60	-	-	-	-

STONE EFFECT

# Realstone\_Navigli



R7JA Grigio Rettificato 75x75 - 29<sup>1/2</sup> x 29<sup>1/2</sup> - R7MA Mosaico 3D Grigio 30x30 - 11<sup>13/16</sup> x 11<sup>13/16</sup>



## Realstone\_Navigli

gres fine porcellanato colorato in massa - rettificato monocalibro / colorbody fine porcelain stoneware - rectified monocaliber / durchgefärbtes feinsteinzeug - rektifiziert, in einem werkmaß / grès cérame fin coloré dans la masse - rectifié monocalibre / gres porcelánico fino coloreado en toda la masa - rectificado monocalibre / гомогенный мелкозернистый керамогранит - ректифицированный монокалиберный

gruppo Bla UNI EN 14411\_G

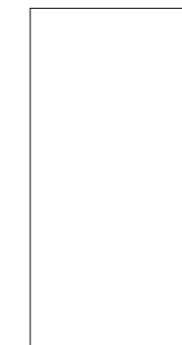

75x150 cm  
29<sup>1/2</sup> x 59<sup>1/8</sup>  
± 9,5 mm

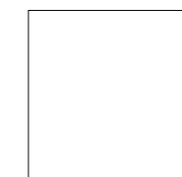

75x75 cm  
29<sup>1/2</sup> x 29<sup>1/2</sup>  
± 9,5 mm

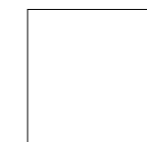

60x60 cm  
23<sup>5/8</sup> x 23<sup>5/8</sup>  
± 9,5 mm



30x60 cm  
11<sup>13/16</sup> x 23<sup>5/8</sup>  
± 9,5 mm

XT20  
Realstone\_Navigli XT20  
> p.396

# Realstone\_Navigli

75x150 - 29<sup>1/2</sup>"x59<sup>1/8</sup>" 75x75 - 29<sup>1/2</sup>"x29<sup>1/2</sup>" 60x60 - 23<sup>5/8</sup>"x23<sup>5/8</sup>" 30x60 - 11<sup>13/16</sup>"x23<sup>5/8</sup>" 30x30 - 11<sup>13/16</sup>"x11<sup>13/16</sup>"

## Grigio



**R7HW** 75x150 Rett  
**R7JA** 75x75 Rett  
**R7JL** 75x75 Strutt Rett  
**R7JT** 60x60 Rett  
**R7JW** 30x60 Rett  
**R7JP** 30x60 Strutt Rett

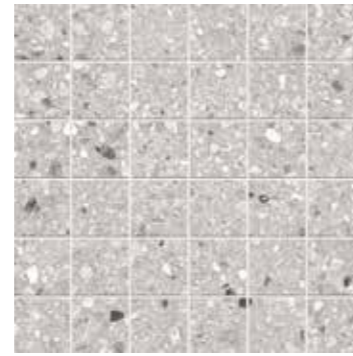

**R7MP** 30x30 Mosaico



**R7MH** 7x60 BT.B.C.  
**R7ML** 7x75 BT.B.C.



**R7MS** 15x60x4 E.ELLE Strutt  
**R7MV** 15x75x4 E.ELLE Strutt

## Naturale

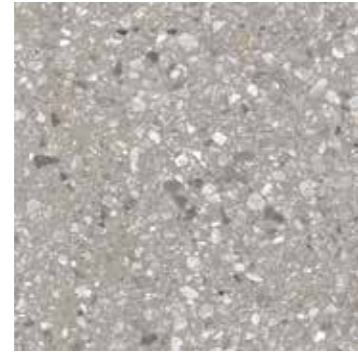

**R7HY** 75x150 Rett  
**R7JC** 75x75 Rett  
**R7JM** 75x75 Strutt Rett  
**R7JU** 60x60 Rett  
**R7JX** 30x60 Rett  
**R7JQ** 30x60 Strutt Rett

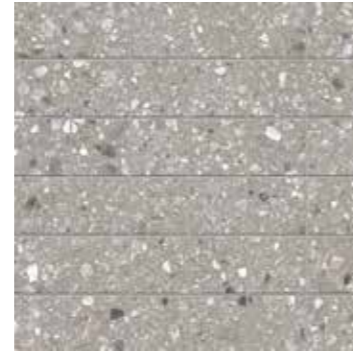

**R7MQ** 30x30 Mosaico



**R7MJ** 7x60 BT.B.C.  
**R7MM** 7x75 BT.B.C.



**R7MT** 15x60x4 E.ELLE Strutt  
**R7MW** 15x75x4 E.ELLE Strutt

## Decors



**R7MA** 30x30 Mosaico 3D Grigio



**R7M7** 30x30 Mosaico 3D Naturale

## TECH INFO

VARIAZIONI CROMATICHE / COLOUR VARIATIONS / FARBVARIATIONEN / VARIATIONS CHROMATIQUES / VARIACIONES CROMÁTICAS / ВАРИАНТЫ ОТТЕНКА



Apprezzabili differenze nell'aspetto di superficie e grafica all'interno della stessa produzione / Clearly distinguishable differences in texture and pattern within the same production run / Auffällige Unterschiede in Aussehen und Struktur innerhalb der gleichen Produktionscharge / Différences visibles au niveau de l'aspect et de la fantaisie entre les carreaux du même lot de production / Diferencias visibles en el aspecto de la superficie y los motivos dentro de un mismo lote de producción / заметные отличия вида поверхности и графики в одной и той же партии

DESTINAZIONE D'USO / INTENDED USE / ANWENDUNGSBEREICH / CHAMP D'APPLICATION / USO PREVISTO / НАЗНАЧЕНИЕ

### H (Naturale/Matt, Strutturato)

Materiali consigliati per sollecitazioni all'abrasione relativamente forti in ambienti anche non protetti da agenti graffianti / Materials recommended for relatively heavy abrasion levels, also in premises not protected against abrasive substances / Materials recommended for relatively heavy abrasion levels, also in premises not protected against abrasive substances / Empfohlen für starke Abriebbeanspruchungen in Bereichen auch ohne Kratzschutzbehandlung / Matériaux recommandés pour des locaux soumis à des fortes contraintes d'abrasion, même non protégés contre les agents abrasifs / Materiales recomendados para soportar esfuerzos de abrasión relativamente intensos incluso en espacios no protegidos frente a agentes abrasivos / Материалы рекомендованы для относительно сильного абразивного воздействия, в том числе в помещениях, не защищенных от царапающих элементов

DECORI / DECORATIVE PIECES / DEKORE / DÉCORS / DECORACIONES / ДЕКОРЫ

### Mosaico, Mosaico 3D

Mosaico assemblato con tratto plastico / Spot-bonded mosaic / Punktverklebtes Mosaik / Mosaïque montée avec trait de colle / Mosaico colocado aplicando cola plástica / Мозаика с сегментами, выполненными из пластмассы - Мозаика, собранная на клеевой точке

PEZZI SPECIALI / TRIMS / SPEZIALTEILE / PIÈCES SPÉCIALES / PIEZAS ESPECIALES / СПЕЦИАЛЬНЫЕ ИЗДЕЛИЯ

### BT.B.C.

Battiscopa Becco Civetta ottenuto da taglio del fondo / Coved Edge Skirting Tile cut from plain tile / Sockelleiste, Halbrundstab, aus Grundfliese geschnitten / Plinthe bord rond découpée dans le fond / Rodapié canto romo conseguido mediante corte del fondo / Плинтус с закругленным краем, полученный из фоновой плитки

### E.Elle

Elemento ad Elle tagliato ed assemblato / Two-piece L-Tile / Schenkelplatte, geschnitten und zusammengesetzt / Élément en L coupé et assemblé / Elemento en forma de "L" cortado y montado / Г-образный элемент, состоящий из двух частей

TECNOLOGIE / TECHNOLOGIES / TECHNOLOGIEN / TECHNOLOGIES / TECNOLOGÍAS / ТЕХНОЛОГИИ

### StepWise

Le piastrelle realizzate con questa nuova tecnologia sono caratterizzate da un'elevata resistenza allo scivolamento e da una superficie morbida al tatto e facile da pulire, data l'assenza di ruvidità superficiale / The tiles produced using this new technology have a high degree of slip resistance and a surface which is soft to the touch and easy to clean, since it has no superficial roughness / Les carreaux utilisant cette nouvelle technologie de production se distinguent par une très grande résistance à la glissance et par une surface douce au toucher et facile à nettoyer puisqu'elle ne présente aucune rugosité / Mit dieser neuen Technologie hergestellte Fliesen zeichnen sich durch eine hohe Rutschhemmung, eine weiche Haptik und eine einfache Reinigung aufgrund der fehlenden Oberflächenrauheit aus / Los azulejos fabricados aplicando esta nueva tecnologia se caracterizan por su elevada resistencia al deslizamiento y por presentar una superficie suave al tacto y fácil de limpiar, dada la nula aspereza de su superficie / Произведенная по этой новой технологии плитка обладает высокой стойкостью к скольжению и мягкой на ощупь, легко очищаемой поверхностью, что обеспечивается отсутствием шероховатости на поверхности

CARATTERISTICHE / CHARACTERISTICS / EIGENSCHAFTEN / CARACTERISTIQUES / DATOS / ХАРАКТЕРИСТИКИ

<b>R10</b> Naturale/Matt <b>R11</b> Strutturato	<b>PENDULUM</b> classe 2 Naturale/Matt classe 3 Strutturato ptv > 36	<b>D-COF</b> > 0,42	<b>BCR</b> μ > 0,40
<b>B</b> Naturale/Matt <b>C</b> Strutturato			
<b>≤ 175 mm²</b>			

CERTIFICAZIONI / CERTIFICATIONS / ZERTIFIZIERUNGEN / CERTIFICACIONES / СЕРТИФИКАЦИИ



IMBALLI / PACKAGING / VERPACKUNGEN / EMBALLAGES / EMBALAJES / УПАКОВКИ

		scatole / box / karton / boîte / caja / корбк			pallet / pallet / palette / palette / pallet / поддон			
		□	M²	KG	□	M²	KG	± mm
75x150	Rettificato	2	2,25	51,81	21	47,25	1088,00	9,5
75x75	Rettificato, Strutturato	2	1,13	23,81	42	47,25	1000,00	9,5
60x60	Rettificato	3	1,08	22,50	40	43,20	900,00	9,5
30x60	Rettificato, Strutturato	6	1,08	23,04	48	51,84	1105,80	9,5
30x30	Mosaico	4	0,36	7,91	60	21,60	480,00	9,5
30x30	Mosaico 3D	4	0,36	8,00	-	-	-	-
7x60	BT.B.C.	14	8,40 ml	12,00	-	-	-	9,5
7x75	BT.B.C.	14	10,50 ml	20,00	-	-	-	9,5
15x60x4	E.ELLE	4	0,36	6,12	-	-	-	-
15x75x4	E.ELLE	2	0,23	10,80	-	-	-	-

STONE EFFECT

# Realstone\_PietrAntica



R78M Bianco Rettificato 60x120 - 23<sup>5/8</sup> x 47<sup>1/4</sup>"



## Realstone\_PietrAntica

gres fine porcellanato colorato in massa - rettificato monocalibro / colorbody fine porcelain stoneware - rectified monocaliber / durchgefärbtes feinsteinzeug - rektifiziert, in einem werkmaß / grès cérame fin coloré dans la masse - rectifié monocalibre / gres porcelánico fino coloreado en toda la masa - rectificado monocalibre / гомогенный мелкозернистый керамогранит - ректифицированный монокалиберный

gruppo Bla UNI EN 14411\_G



naturale/ outdoor  
matt



60x120 cm  
23<sup>5/8</sup> x 47<sup>1/4</sup>"  
± 9,5 mm



60x60 cm  
23<sup>5/8</sup> x 23<sup>5/8</sup>"  
± 9,5 mm



30x60 cm  
11<sup>13/16</sup> x 23<sup>5/8</sup>"  
± 9,5 mm

XT20  
Realstone\_PietrAntica XT20  
> p.400

# Realstone\_PietrAntica

60x120 - 23<sup>5/8</sup> x 47<sup>1/4</sup> 60x60 - 23<sup>5/8</sup> x 23<sup>5/8</sup> 30x60 - 11<sup>13/16</sup> x 23<sup>5/8</sup> 30x30 - 11<sup>13/16</sup> x 11<sup>13/16</sup> 15x30 - 5<sup>7/8</sup> x 11<sup>13/16</sup>

## Bianco



- R78Z** 60x120 Smooth Rett
- R78M** 60x120 Rett
- R793** 60x60 Smooth Rett
- R78R** 60x60 Rett
- R7JG** 60x60 Strutt Rett
- R799** 30x60 Smooth Rett
- R78V** 30x60 Rett
- R7DJ** 30x60 Strutt Rett



- R7MY** 30x30 Mosaico



- R7NC** 7x60 BT.B.C.

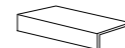

- R8FD** 15x60x4 E.ELLE Strutt



- R8DU** 32,5x120 BT.B.C.

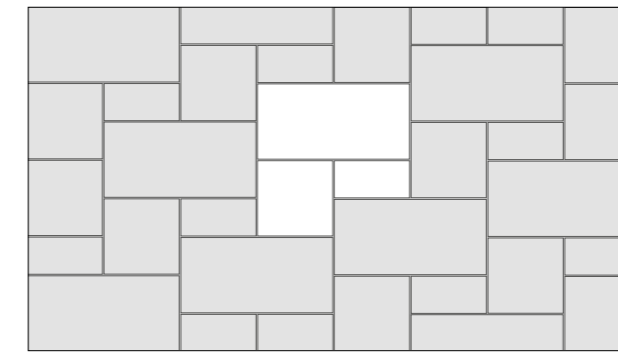

La fuga consigliata per la posa modulare della superficie outdoor nei formati 60x120, 60x60 e 30x60 cm è di 4 mm / The recommended joint for the modular installation of the outdoor surface in the 60x120, 60x60 and 30x60 cm sizes is 4 mm / Nous recommandons un joint de 4 mm pour la pose modulaire de la surface outdoor dans les formats 60x120, 60x60 et 30x60 cm / Für die modulare Verlegung des Außenbelags in den Formaten 60x120, 60x60 und 30x60 cm wird eine Fuge von 4 mm empfohlen / La junta de separación recomendada para la colocación modular en superficies exteriores en los formatos de 60 x 120, 60 x 60 y 30 x 60 cm es de 4 mm / Рекомендованная ширина шва для модульной укладки материалов для наружных пространств в форматах 60x120, 60x60 и 30x60 см равна 4 мм

## Beige



- R790** 60x120 Smooth Rett
- R78N** 60x120 Rett
- R794** 60x60 Smooth Rett
- R78S** 60x60 Rett
- R7JH** 60x60 Strutt Rett
- R79A** 30x60 Smooth Rett
- R78W** 30x60 Rett
- R7DK** 30x60 Strutt Rett



- R7MZ** 30x30 Mosaico



- R7ND** 7x60 BT.B.C.



- R8FE** 15x60x4 E.ELLE Strutt



- R8DV** 32,5x120 BT.B.C.

## Decors



- R7QY** 15x30 Muretto Bianco



- R7QZ** 15x30 Muretto Beige



- R7RA** 15x30 Muretto Multicolor

## Multicolor



- R791** 60x120 Smooth Rett
- R78P** 60x120 Rett
- R795** 60x60 Smooth Rett
- R78T** 60x60 Rett
- R7JJ** 60x60 Strutt Rett
- R79C** 30x60 Smooth Rett
- R78X** 30x60 Rett
- R7DL** 30x60 Strutt Rett



- R7N9** 30x30 Mosaico



- R7NE** 7x60 BT.B.C.



- R8FF** 15x60x4 E.ELLE Strutt



- R8DW** 32,5x120 BT.B.C.



- R7RH** 30x30 Decoro Cementine Caldi

Abbinabile ai colori / Matching with colours / Mit den Grundfliesen kombinierbar / Peut s'associer aux carreaux de base de couleurs / Puede combinarse con los fondos / Сочетается с фоновой плиткой



**Beige**



- R8DF** 30x30 Decoro Cementine Freddi

Abbinabile ai colori / Matching with colours / Mit den Grundfliesen kombinierbar / Peut s'associer aux carreaux de base de couleurs / Puede combinarse con los fondos / Сочетается с фоновой плиткой



**Bianco Multicolor**

# Realstone\_PietrAntica

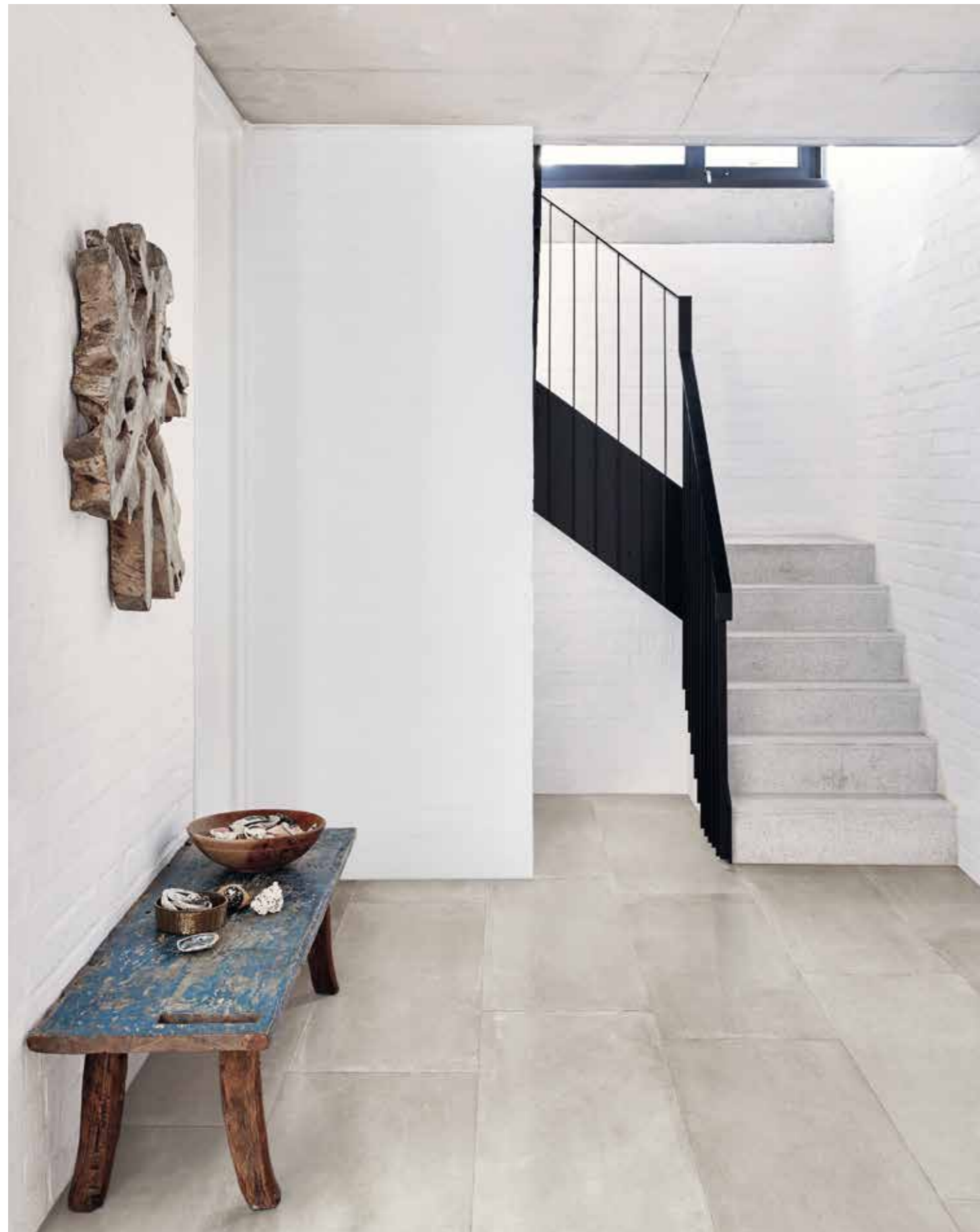

R78Z Bianco Smooth Rettificato 60x120 - 23<sup>9/16</sup>"x47<sup>1/4</sup>"

## TECH INFO

VARIAZIONI CROMATICHE / COLOUR VARIATIONS / FARBVARIATIONEN / VARIATIONS CHROMATIQUES / VARIACIONES CROMÁTICAS / ВАРИАНТЫ ОТТЕКHA

### V2 (Bianco, Beige)

Apprezzabili differenze nell'aspetto di superficie e grafica all'interno della stessa produzione / Clearly distinguishable differences in texture and pattern within the same production run / Auffällige Unterschiede in Aussehen und Struktur innerhalb der gleichen Produktionscharge / Différences visibles au niveau de l'aspect et de la fantaisie entre les carreaux du même lot de production / Diferencias visibles en el aspecto de la superficie y los motivos dentro de un mismo lote de producción / заметные отличия вида поверхности и графики в одной и той же партии

### V4 (Multicolor)

Variazioni irregolari da piastrella a piastrella. Una piastrella può differire totalmente nell'aspetto superficiale e colore da un'altra. Si consiglia divisionare la gamma cromatica prima della selezione del materiale / Random differences from tile to tile. One tile may have totally different texture and colour from another. The colour range should be viewed before selecting the material / Wesentliche Variationen von Fliese zu Fliese. Eine Fliese kann sich in Aussehen und Farbe komplett von einer anderen unterscheiden. Es wird empfohlen, das Farbsortiment vor der Auswahl des Materials zu prüfen / Variations irrégulières entre les carreaux. L'aspect et la couleur peuvent être complètement différents d'un carreau à l'autre. Il est recommandé de consulter la gamme des couleurs avant de sélectionner le matériel / Variaciones irregulares entre un azulejo y otro. Un azulejo puede ser completamente diferente de otro en el aspecto superficial y el color. Es aconsejable visualizar la gama cromática antes de seleccionar el material / Неоднородные изменения на разных плитках. Каждая плитка может полностью отличаться по виду поверхности и цвету от другой. Перед отбором материала рекомендуется просмотреть цветовую гамму

DESTINAZIONE D'USO / INTENDED USE / ANWENDUNGSBEREICH / CHAMP D'APPLICATION / USO PREVISTO / НАЗНАЧЕНИЕ

### G (Smooth)

Materiali consigliati per locali sottoposti a sollecitazioni all'abrasione medio pesanti come: case individuali, commerciale leggero / Materials recommended for premises with medium-heavy abrasion levels, such as: detached homes, light-traffic commercial premises / Empfohlen für Räume mit mittelschwerer Abriebbeanspruchung wie: Einfamilienhäuser, leicht beanspruchte Gewerbebereiche / Matériaux recommandés pour des locaux soumis à des contraintes d'abrasion moyennes et fortes comme: maisons particulières, espaces commerciaux soumis à un trafic léger, etc / Materiales recomendados para locales sometidos a esfuerzos de abrasión medio-pesados, como casas unifamiliares y locales comerciales de tráfico ligero / Материалы рекомендованы для использования в частных домах и коммерческих помещениях, подверженных средне-сильному абразивному воздействию

CARATTERISTICHE / CHARACTERISTICS / EIGENSCHAFTEN / CARACTERISTIQUES / DATOS / ХАРАКТЕРИСТИКИ

	R10 Naturale/Matt R11 Strutturato	PENDULUM classe 1 Naturale/Matt classe 3 Strutturato ptv > 36 Strutturato	D-COF > 0,42 Nat, Strutt	BCR μ > 0,40 Nat, Strutt
	A Naturale/Matt C Strutturato			
	≤ 175 mm <sup>2</sup>			

### H (Naturale/Matt, Strutturato)

Materiali consigliati per sollecitazioni all'abrasione relativamente forti in ambienti anche non protetti da agenti graffianti / Materials recommended for relatively heavy abrasion levels, also in premises not protected against abrasive substances / Materials recommended for relatively heavy abrasion levels, also in premises not protected against abrasive substances / Empfohlen für starke Abriebbeanspruchungen in Bereichen auch ohne Kratzschutzbehandlung / Matériaux recommandés pour des locaux soumis à des fortes contraintes d'abrasion, même non protégés contre les agents abrasifs / Materiales recomendados para soportar esfuerzos de abrasión relativamente intensos incluso en espacios no protegidos frente a agentes abrasivos / Материалы рекомендованы для относительно сильного абразивного воздействия, в том числе в помещениях, не защищенных от царапающих элементов

DECORI / DECORATIVE PIECES / DEKORE / DÉCORS / DECORACIONES / ДЕКОРЫ

### Decoro Cementine

6 diversi soggetti / 6 different motifs / 6 verschiedene Motive / 6 sujets différents / 6 temas diferentes / 6 различных рисунка

### Mosaico, Muretto

Mosaico assemblato con tratto plastico / Spot-bonded mosaic / Punktverklebtes Mosaik / Mosaïque montée avec trait de colle / Mosaico colocado aplicando cola plástica / Мозаика с сегментами, выполненными из пластмассы - Мозаика, собранная на клеевой точке

PEZZI SPECIALI / TRIMS / SPEZIALTEILE / PIÈCES SPÉCIALES / PIEZAS ESPECIALES / СПЕЦИАЛЬНЫЕ ИЗДЕЛИЯ

### BT.B.C.

Battiscopa Becco Civetta ottenuto da taglio del fondo / Coved Edge Skirting Tile cut from plain tile / Sockelleiste, Halbrundstab, aus Grundfliese geschnitten / Plinthe bord rond découpée dans le fond / Rodapié canto romo conseguido mediante corte del fondo / Плинтус с закругленным краем, полученный из фоновой плитки

### E.Elle

Elemento ad Elle tagliato ed assemblato / Two-piece L-Tile / Schenkelplatte, geschnitten und zusammengesetzt / Élément en L coupé et assemblé / Elemento en forma de "L" cortado y montado / Г-образный элемент, состоящий из двух частей

### GR.

Gradone lineare tagliato ed assemblato / Two-piece straight step / stufenplatte gerade geschnitten und zusammengesetzt / Large marche droite coupée et assemblée / Escalón lineal cortado y montado / Собранная загибающаяся линейная ступень со срезом

CERTIFICAZIONI / CERTIFICATIONS / ZERTIFIZIERUNGEN / CERTIFICATIONS / CERTIFICACIONES / СЕРТИФИКАЦИИ



IMBALLI / PACKAGING / VERPACKUNGEN / EMBALLAGES / EMBALAJES / УПАКОВКИ

		scatole / box / karton / boîte / caja / коробк			pallet / pallet / palette / palette / pallet / поддон			
		□	M <sup>2</sup>	KG	□	M <sup>2</sup>	KG	+ mm
60x120	Smooth, Rett	2	1,44	31,47	36	51,84	1132,85	9,5
60x60	Smooth, Rett, Strutt	3	1,08	22,50	40	43,20	900,00	9,5
30x60	Smooth, Rett, Strutt	6	1,08	23,04	48	51,84	1105,80	9,5
30x30	Mosaico	4	0,36	8,00	60	21,60	480,00	9,5
30x30	Decoro Cementine	6	0,54	10,00	64	34,56	640,00	9,5
15x30	Muretto	4	0,18	4,00	-	-	-	-
7x60	BT.B.C.	14	8,40 ml	20,00	-	-	-	9,5
15x60x4	E.ELLE Strutt	4	0,36	7,00	-	-	-	-
32,5x120	GR.	2	0,78 ml	21,00	-	-	-	-

STONE EFFECT

# Realstone\_Slate



R5ZD Musk Rettificato 75x75 - 29 1/2" x 29 1/2"



## Realstone\_Slate

gres fine porcellanato colorato in massa - rettificato monocalibro / colorbody fine porcelain stoneware - rectified monocaliber / durchgefärbtes feinsteinzeug - rektifiziert, in einem werkmaß / grès cérame fin coloré dans la masse - rectifié monocalibre / gres porcelánico fino coloreado en toda la masa - rectificado monocalibre / гомогенный мелкозернистый керамогранит - ректифицированный монокалиберный

gruppo Bla UNI EN 14411\_G



naturale/  
matt outdoor



75x150 cm  
29 1/2" x 59 1/8"  
± 10,5 mm

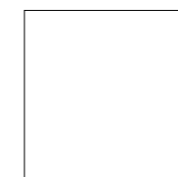

75x75 cm  
29 1/2" x 29 1/2"  
± 10 mm

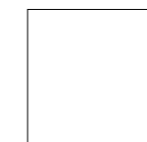

60x60 cm  
23 5/8" x 23 5/8"  
± 10 mm

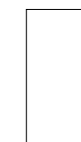

30x60 cm  
11 13/16" x 23 5/8"  
± 10 mm

XT20  
Realstone\_Slate XT20  
> p.406

# Realstone\_Slate

75x150 - 29<sup>1/2</sup> x 59<sup>1/8</sup>" 75x75 - 29<sup>1/2</sup> x 29<sup>1/2</sup>" 60x60 - 23<sup>5/8</sup> x 23<sup>5/8</sup>" 30x60 - 11<sup>13/16</sup> x 23<sup>5/8</sup>" 37x41 - 14<sup>9/16</sup> x 16<sup>1/8</sup>" 30x30 - 11<sup>13/16</sup> x 11<sup>13/16</sup>"

## Ice



**R5YP** 75x150 Rett  
**R5YZ** 75x75 Rett  
**R612** 75x75 Strutt Rett  
**R5ZF** 60x60 Rett  
**R5ZL** 30x60 Rett  
**R6YS** 30x60 Strutt Rett



**R6GQ** 30x30 Mosaico



**R6FP** 7x60 BT.B.C.  
**R6FG** 7x75 BT.B.C.



**R6YY** 15x60x4 E.ELLE  
**R6XS** 15x75x4 E.ELLE

## Musk



**R5YS** 75x150 Rett  
**R5ZD** 75x75 Rett  
**R615** 75x75 Strutt Rett  
**R5ZJ** 60x60 Rett  
**R5ZP** 30x60 Rett  
**R6YV** 30x60 Strutt Rett

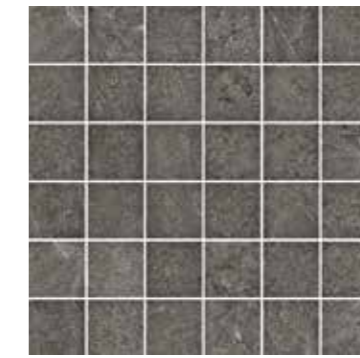

**R6GX** 30x30 Mosaico



**R6FW** 7x60 BT.B.C.  
**R6FK** 7x75 BT.B.C.



**R6ZC** 15x60x4 E.ELLE  
**R6XX** 15x75x4 E.ELLE

## Shell



**R5YQ** 75x150 Rett  
**R5ZA** 75x75 Rett  
**R613** 75x75 Strutt Rett  
**R5Z6** 60x60 Rett  
**R5ZM** 30x60 Rett  
**R6YT** 30x60 Strutt Rett



**R6GS** 30x30 Mosaico



**R6FR** 7x60 BT.B.C.  
**R6FH** 7x75 BT.B.C.



**R6YZ** 15x60x4 E.ELLE  
**R6XU** 15x75x4 E.ELLE

## Black



**R5YT** 75x150 Rett  
**R5ZE** 75x75 Rett  
**R618** 75x75 Strutt Rett  
**R5ZK** 60x60 Rett  
**R5ZQ** 30x60 Rett  
**R6YW** 30x60 Strutt Rett

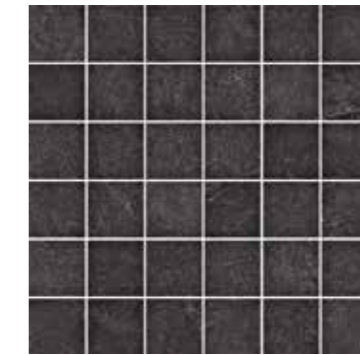

**R6GZ** 30x30 Mosaico



**R6FY** 7x60 BT.B.C.  
**R6FL** 7x75 BT.B.C.



**R6ZD** 15x60x4 E.ELLE  
**R6XY** 15x75x4 E.ELLE

## Iron



**R5YR** 75x150 Rett  
**R5ZC** 75x75 Rett  
**R614** 75x75 Strutt Rett  
**R5ZH** 60x60 Rett  
**R5ZN** 30x60 Rett  
**R6YU** 30x60 Strutt Rett



**R6GV** 30x30 Mosaico



**R6FU** 7x60 BT.B.C.  
**R6FJ** 7x75 BT.B.C.



**R6ZA** 15x60x4 E.ELLE  
**R6XW** 15x75x4 E.ELLE



# Realstone\_Slate

75x150 - 29<sup>1/2</sup>"x59<sup>1/8</sup>" 75x75 - 29<sup>1/2</sup>"x29<sup>1/2</sup>" 60x60 - 23<sup>5/8</sup>"x23<sup>5/8</sup>" 30x60 - 11<sup>13/16</sup>"x23<sup>5/8</sup>" 37x41 - 14<sup>9/16</sup>"x16<sup>1/8</sup>" 30x30 - 11<sup>13/16</sup>"x11<sup>13/16</sup>"

## Decors



**R66C** 37x41 Mosaico Freccia Ice

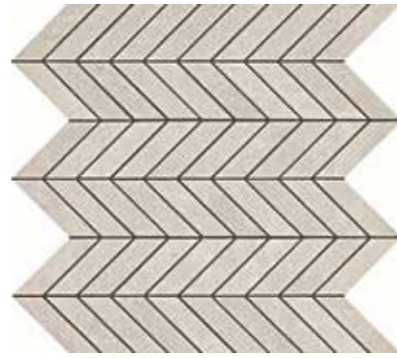

**R66E** 37x41 Mosaico Freccia Shell



**R66G** 37x41 Mosaico Freccia Iron



**R66K** 37x41 Mosaico Freccia Musk



**R66M** 37x41 Mosaico Freccia Black

## TECH INFO

VARIAZIONI CROMATICHE / COLOUR VARIATIONS / FARBVARIATIONEN / VARIATIONS CHROMATIQUES / VARIACIONES CROMÁTICAS / ВАРИАНТЫ ОТТЕНКА



Apprezzabili differenze nell'aspetto di superficie e grafica all'interno della stessa produzione / Clearly distinguishable differences in texture and pattern within the same production run / Auffällige Unterschiede in Aussehen und Struktur innerhalb der gleichen Produktionscharge / Différences visibles au niveau de l'aspect et de la fantaisie entre les carreaux du même lot de production / Diferencias visibles en el aspecto de la superficie y los motivos dentro de un mismo lote de producción / заметные отличия вида поверхности и графики в одной и той же партии

DESTINAZIONE D'USO / INTENDED USE / ANWENDUNGSBEREICH / CHAMP D'APPLICATION / USO PREVISTO / НАЗНАЧЕНИЕ

### H (Naturale/Matt, Strutturato)

Materiali consigliati per sollecitazioni all'abrasione relativamente forti in ambienti anche non protetti da agenti graffianti / Materials recommended for relatively heavy abrasion levels, also in premises not protected against abrasive substances / Materials recommended for relatively heavy abrasion levels, also in premises not protected against abrasive substances / Empfohlen für starke Abriebbeanspruchungen in Bereichen auch ohne Kratzschutzbehandlung / Matériaux recommandés pour des locaux soumis à des fortes contraintes d'abrasion, même non protégés contre les agents abrasifs / Materiales recomendados para soportar esfuerzos de abrasión relativamente intensos incluso en espacios no protegidos frente a agentes abrasivos / Материалы рекомендованы для относительно сильного абразивного воздействия, в том числе в помещениях, не защищенных от царапающих элементов

DECORI / DECORATIVE PIECES / DEKORE / DÉCORS / DECORACIONES / ДЕКОРЫ

### Mosaico

Mosaico assemblato con tratto plastico / Spot-bonded mosaic / Punktverklebtes Mosaik / Mosaïque montée avec trait de colle / Mosaico colocado aplicando cola plástica / Мозаика с сегментами, выполненными из пластмассы - Мозаика, собранная на клеевой точке

### Mosaico Freccia

Mosaico assemblato su rete in fibra di vetro / Mosaic mesh - mounted on fibreglass / Auf Glasfasernetz geklebtes Mosaik / Mosaïque montée sur filet en fibre de verre / Mosaico enmallado sobre fibra de vidrio / Мозаика, собранная на сетке из стекловолокна

PEZZI SPECIALI / TRIMS / SPEZIALTEILE / PIÈCES SPÉCIALES / PIEZAS ESPECIALES / СПЕЦИАЛЬНЫЕ ИЗДЕЛИЯ

### BT.B.C.

Battiscopa Becco Civetta ottenuto da taglio del fondo / Coved Edge Skirting Tile cut from plain tile / Sockelleiste, Halbrundstab, aus Grundfliese geschnitten / Plinthe bord rond découpée dans le fond / Rodapié canto romo conseguido mediante corte del fondo / Плинтус с закругленным краем, полученный из фоновой плитки

### E.Elle

Elemento ad Elle tagliato ed assemblato / Two-piece L-Tile / Schenkelplatte, geschnitten und zusammengesetzt / Élément en L coupé et assemblé / Elemento en forma de "L" cortado y montado / Г-образный элемент, состоящий из двух частей

CARATTERISTICHE / CHARACTERISTICS / EIGENSCHAFTEN / CARACTERISTIQUES / DATOS / ХАРАКТЕРИСТИКИ

<b>R10</b> Naturale/Matt	<b>PENDULUM</b>	<b>D-COF</b>	<b>BCR</b>
<b>R11</b> Strutturato	<b>classe 1</b> Naturale/Matt <b>classe 2</b> Strutturato <b>ptv &gt; 36</b> Strutturato <b>ptv &gt; 36</b> Naturale/Matt (slider 96)	<b>&gt; 0,42</b>	<b>μ &gt; 0,40</b>
<b>C</b> Strutturato			
<b>≤ 175 mm<sup>2</sup></b>			

CERTIFICAZIONI / CERTIFICATIONS / ZERTIFIZIERUNGEN / CERTIFICACIONES / СЕРТИФИКАЦИИ



IMBALLI / PACKAGING / VERPACKUNGEN / EMBALLAGES / EMBALAJES / УПАКОВКИ

	scatole / box / karton / boîte / caja / короб			pallet / pallet / palette / palette / pallet / поддон				
	□	M <sup>2</sup>	KG	□	M <sup>2</sup>	KG	± mm	
75x150	2	2,25	55,99	21	47,25	1175,69	10,5	
75x75	2	1,13	25,48	42	47,25	1070,30	10	
60x60	3	1,08	23,38	40	43,20	935,06	10	
30x60	6	1,08	23,25	48	51,84	1116,04	10	
30x30	4	0,36	8,50	80	28,80	660,00	10	
37x41	Mosaico	4	0,51	15,49	52	26,93	801,79	10
7x60	Mosaico Freccia	4	0,51	15,49	52	26,93	801,79	10
7x75	BT.B.C.	15	9,00 ml	14,50	-	-	10	
15x60x4	BT.B.C.	13	9,75 ml	18,42	-	-	10	
15x75x4	E.ELLE	4	0,36	7,50	-	-	-	
	E.ELLE	2	0,23	10,00	-	-	-	

STONE EFFECT

# Realstone\_Rain

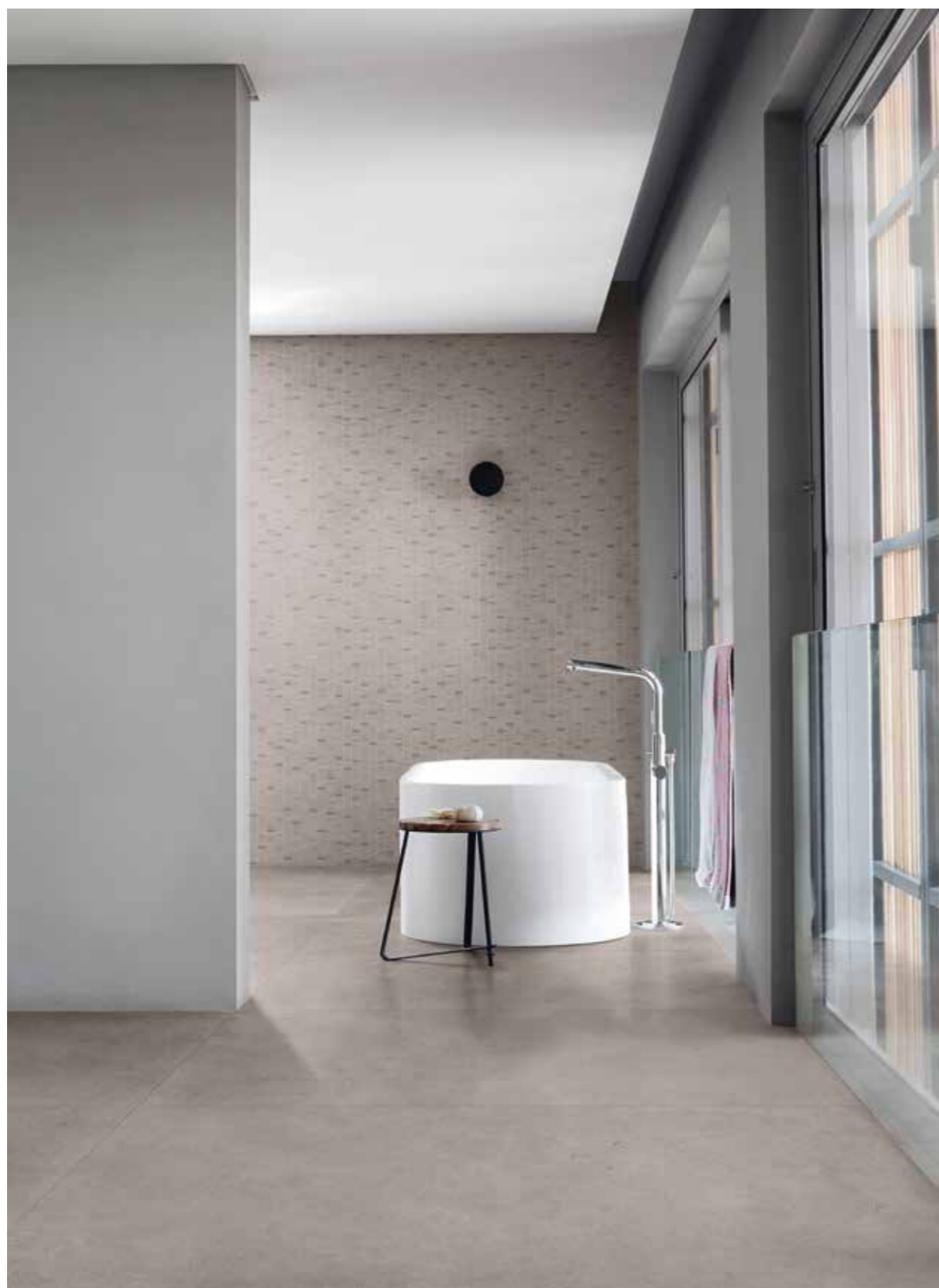

R84X Taupe 75x150 - 29<sup>1/2</sup>"x59<sup>5/8</sup>" - R5UL Mosaico Taupe 30x30 - 11<sup>13/16</sup>"x11<sup>13/16</sup>"





## Realstone\_Rain

gres fine porcellanato colorato in massa - rettificato monocalibro / colorbody fine porcelain stoneware - rectified monocaliber / durchgefärbtes feinsteinzeug - rektifiziert, in einem werkmaß / grès cérame fin coloré dans la masse - rectifié monocalibre / gres porcelánico fino coloreado en toda la masa - rectificado monocalibre / гомогенный мелкозернистый керамогранит - ректифицированный монокалиберный

gruppo Bla UNI EN 14411\_G

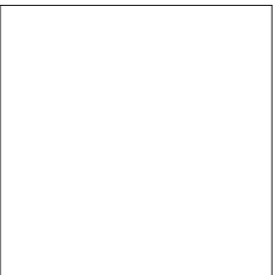
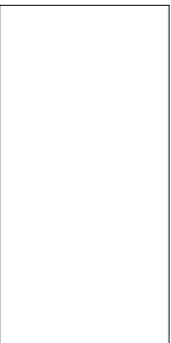
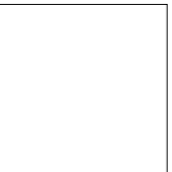
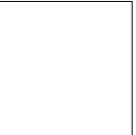

				
<b>120x120 cm</b> 47 <sup>1/4</sup> "x47 <sup>1/4</sup> " ± 10,5 mm	<b>75x150 cm</b> 29 <sup>1/2</sup> "x59 <sup>5/8</sup> " ± 9,5 mm	<b>75x75 cm</b> 29 <sup>1/2</sup> "x29 <sup>1/2</sup> " ± 9,5 mm	<b>60x60 cm</b> 23 <sup>5/8</sup> "x23 <sup>5/8</sup> " ± 9,5 mm	<b>30x60 cm</b> 11 <sup>13/16</sup> "x23 <sup>5/8</sup> " ± 9,5 mm

XT20  
Realstone\_Rain XT20  
> p.410

# Realstone\_Rain

120x120 - 47<sup>1/4</sup>"x47<sup>1/4</sup>" 75x150 - 29<sup>1/2</sup>"x59<sup>1/8</sup>" 75x75 - 29<sup>1/2</sup>"x29<sup>1/2</sup>" 60x60 - 23<sup>5/8</sup>"x23<sup>5/8</sup>" 30x60 - 11<sup>13/16</sup>"x23<sup>5/8</sup>" 30x30 - 11<sup>13/16</sup>"x11<sup>13/16</sup>"



## Almond

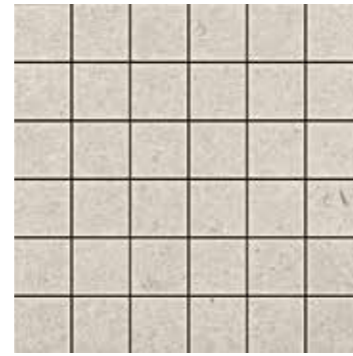

- R1GT 120x120 Rett
- R84V 75x150 Rett
- R84Y 75x150 Soft Rett
- R86E 75x75 Rett
- R84S 75x75 Soft Rett
- R857 60x60 Rett
- R85D 60x60 Soft Rett
- R85G 30x60 Rett
- R85K 30x60 Soft Rett
- R1EE 30x60 Strutt Rett



R1FZ 30x30 Mosaico

-  R729 7x60 BT.B.C.
-  R72D 7x75 BT.B.C.
-  RAZX 15x60x4 E.ELLE



R69T 60x60 Strutturato Righe Rett



## Greige

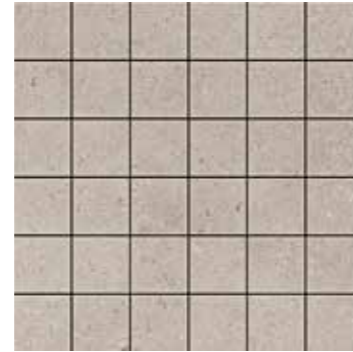

- R1H5 120x120 Rett
- R84W 75x150 Rett
- R84Z 75x150 Soft Rett
- R86F 75x75 Rett
- R84T 75x75 Soft Rett
- R85A 60x60 Rett
- R85E 60x60 Soft Rett
- R85H 30x60 Rett
- R85L 30x60 Soft Rett
- R1FX 30x60 Strutt Rett



R1GH 30x30 Mosaico

-  R72A 7x60 BT.B.C.
-  R72E 7x75 BT.B.C.
-  RAZY 15x60x4 E.ELLE



R69U 60x60 Strutturato Righe Rett



## Taupe

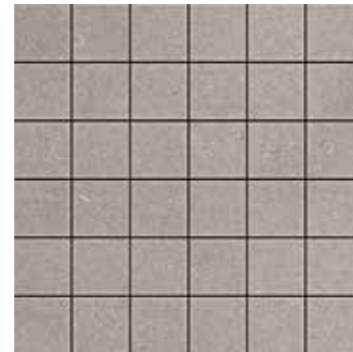

- R1H7 120x120 Rett
- R84X 75x150 Rett
- R852 75x150 Soft Rett
- R86G 75x75 Rett
- R86U 75x75 Soft Rett
- R85C 60x60 Rett
- R85F 60x60 Soft Rett
- R85J 30x60 Rett
- R85M 30x60 Soft Rett
- R1FY 30x60 Strutt Rett



R1GJ 30x30 Mosaico

-  R72C 7x60 BT.B.C.
-  R72F 7x75 BT.B.C.
-  RAZZ 15x60x4 E.ELLE



R69V 60x60 Strutturato Righe Rett

# Realstone\_Rain

120x120 - 47<sup>1/4</sup> x 47<sup>1/4</sup> 75x150 - 29<sup>1/2</sup> x 59<sup>1/8</sup> 75x75 - 29<sup>1/2</sup> x 29<sup>1/2</sup> 60x60 - 23<sup>5/8</sup> x 23<sup>5/8</sup> 30x60 - 11<sup>13/16</sup> x 23<sup>5/8</sup> 30x30 - 11<sup>13/16</sup> x 11<sup>13/16</sup>

## Decors



R5UJ 30x30 Mosaico Almond\*



R5UK 30x30 Mosaico Greige\*



R5UL 30x30 Mosaico Taupe\*



R5UN 30x30 Mosaico Mix

Abbinabile ai colori / Matching with colours / Mit den Grundfliesen kombinierbar / Peut s'associer aux carreaux de base de couleurs / Puede combinarse con los fondos / Сочетается с фоновой плиткой



Almond Greige Taupe



R5TU 30x30 Mosaico Rombi Almond

Abbinabile ai colori / Matching with colours / Mit den Grundfliesen kombinierbar / Peut s'associer aux carreaux de base de couleurs / Puede combinarse con los fondos / Сочетается с фоновой плиткой



Almond Taupe

## TECH INFO

VARIAZIONI CROMATICHE / COLOUR VARIATIONS / FARBVARIATIONEN / VARIATIONS CHROMATIQUES / VARIACIONES CROMÁTICAS / ВАРИАНТЫ ОТТЕККА



V2

Apprezzabili differenze nell'aspetto di superficie e grafica all'interno della stessa produzione / Clearly distinguishable differences in texture and pattern within the same production run / Auffällige Unterschiede in Aussehen und Struktur innerhalb der gleichen Produktionscharge / Différences visibles au niveau de l'aspect et de la fantaisie entre les carreaux du même lot de production / Diferencias visibles en el aspecto de la superficie y los motivos dentro de un mismo lote de producción / заметные отличия вида поверхности и графики в одной и той же партии

DESTINAZIONE D'USO / INTENDED USE / ANWENDUNGSBEREICH / CHAMP D'APPLICATION / USO PREVISTO / НАЗНАЧЕНИЕ

### H (Naturale/Matt, Soft, Strutturato)

Materiali consigliati per sollecitazioni all'abrasione relativamente forti in ambienti anche non protetti da agenti graffianti / Materials recommended for relatively heavy abrasion levels, also in premises not protected against abrasive substances / Materials recommended for relatively heavy abrasion levels, also in premises not protected against abrasive substances / Empfohlen für starke Abriebbeanspruchungen in Bereichen auch ohne Kratzschutzbehandlung / Matériaux recommandés pour des locaux soumis à des fortes contraintes d'abrasion, même non protégés contre les agents abrasifs / Materiales recomendados para soportar esfuerzos de abrasión relativamente intensos incluso en espacios no protegidos frente a agentes abrasivos / Материалы рекомендованы для относительно сильного абразивного воздействия, в том числе в помещениях, не защищенных от царапающих элементов

DECORI / DECORATIVE PIECES / DEKORE / DÉCORS / DECORACIONES / ДЕКОРЫ

### Mosaico, Mosaico\*, Mosaico Mix, Mosaico Rombi

Mosaico assemblato su rete in fibra di vetro / Mosaico mesh - mounted on fibreglass / Auf Glasfasernetz geklebtes Mosaik / Mosaïque montée sur filet en fibre de verre / Mosaico enmallado sobre fibra de vidrio / Мозаика, собранная на сетке из стекловолокна

CARATTERISTICHE / CHARACTERISTICS / EIGENSCHAFTEN / CARACTERISTIQUES / DATOS / ХАРАКТЕРИСТИКИ

	R9 Soft	<b>PENDULUM</b> classe 1 Soft classe 2 Naturale/Matt classe 3 Strutturato pTV > 36 Nat/Strutt	<b>D-COF</b> > 0,42	<b>BCR</b> μ > 0,40
	R10 Naturale/Matt			
	R11 Strutturato			
	C Strutturato			
	≤ 175 mm²			

CERTIFICAZIONI / CERTIFICATIONS / ZERTIFIZIERUNGEN / CERTIFICACIONES / СЕРТИФИКАЦИИ



IMBALLI / PACKAGING / VERPACKUNGEN / EMBALLAJES / УПАКОВКИ

		scatole / box / karton / boîte / caja / коробк			pallet / pallet / palette / palette / pallet / поддон			
		□	M²	KG	□	M²	KG	± mm
120x120	Naturale/Matt	1	1,44	36,99	36	51,84	1351,36	10,5
75x150	Naturale/Matt, Soft	2	2,25	55,99	21	47,25	1175,69	9,5
75x75	Naturale/Matt, Soft	2	1,13	23,81	42	47,25	1000,00	9,5
60x60	Naturale/Matt, Soft	3	1,08	23,20	40	43,20	928,03	9,5
60x60	Strutt Righe	3	1,08	23,20	40	43,20	928,03	9,5
30x60	Naturale/Matt, Soft	5	0,90	19,31	48	43,20	926,84	9,5
30x60	Strutturato	6	1,08	23,00	48	51,84	1103,92	9,5
30x30	Mosaico	4	0,36	7,72	80	28,80	618,00	9,5
30x30	Mos. R1FZ-R1GH-R1GJ	4	0,36	8,00	80	28,80	666,00	9,5
7x60	BT.B.C.	15	9,00 ml	18,18	-	-	-	10
7x75	BT.B.C.	14	10,50 ml	18,42	-	-	-	9,5
15x60x4	E.ELLE	4	0,36	8,70	-	-	-	-

STONE EFFECT

# Realstone\_Cardoso



R04D Grigio 75x75 - 29<sup>1/2</sup>"x29<sup>1/2</sup>" - R08V Muretto Grigio 30x60 - 11<sup>13/16</sup>"x23<sup>5/8</sup>"



## Realstone\_Cardoso

gres fine porcellanato colorato in massa - rettificato monocalibro / colorbody fine porcelain stoneware - rectified monocaliber / durchgefärbtes feinsteinzeug - rektifiziert, in einem werkmaß / grès cérame fin coloré dans la masse - rectifié monocalibre / gres porcelánico fino coloreado en toda la masa - rectificado monocalibre / гомогенный мелкозернистый керамогранит - ректифицированный монокалиберный

gruppo Bla UNI EN 14411\_G



naturale/  
matt outdoor



60x120 cm  
23<sup>5/8</sup>"x47<sup>1/4</sup>"  
± 9,5 mm



75x75 cm  
29<sup>1/2</sup>"x29<sup>1/2</sup>"  
± 9,5 mm

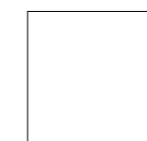

60x60 cm  
23<sup>5/8</sup>"x23<sup>5/8</sup>"  
± 9,5 mm



30x60 cm  
11<sup>13/16</sup>"x23<sup>5/8</sup>"  
± 9,5 mm

XT20  
Realstone\_Cardoso XT20  
> p.414

# Realstone\_Cardoso

60x120 - 23<sup>5/8"</sup> x 47<sup>1/4"</sup> 75x75 - 29<sup>1/2"</sup> x 29<sup>1/2"</sup> 60x60 - 23<sup>5/8"</sup> x 23<sup>5/8"</sup> 30x60 - 11<sup>13/16"</sup> x 23<sup>5/8"</sup> 37x24,5 - 14<sup>9/16"</sup> x 9<sup>5/8"</sup> 30x30 - 11<sup>13/16"</sup> x 11<sup>13/16"</sup>

## Grigio

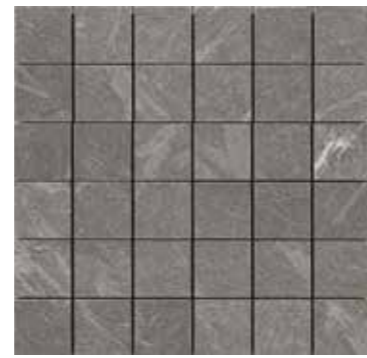

**R12H** 7x60 BT.B.C.  
**R12G** 7x75 BT.B.C.



**R02D** 15x60x4 E.ELLE

- R04B** 60x120 Rett
- R07P** 60x120 Soft Rett
- R049** 60x120 Strutt Rett
- R04D** 75x75 Rett
- R07N** 75x75 Soft Rett
- R04A** 60x60 Rett
- R07Q** 60x60 Soft Rett
- R04C** 60x60 Strutt Rett
- R05R** 30x60 Rett
- R07R** 30x60 Soft Rett
- R05S** 30x60 Strutt Rett

**R08U** 30x30 Mosaico 3D

## Decors

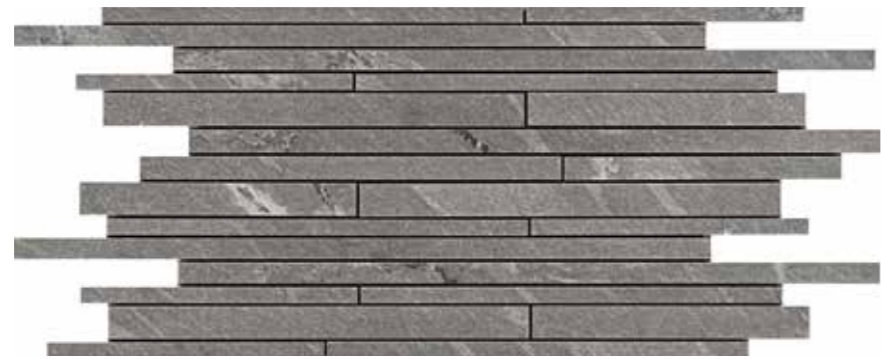

**R08V** 30x60 Muretto Grigio



**R12A** 37x24,5 Realstone Mosaico Mix

## TECH INFO

VARIAZIONI CROMATICHE / COLOUR VARIATIONS / FARBVARIATIONEN / VARIATIONS CHROMATIQUES / VARIACIONES CROMÁTICAS / ВАРИАНТЫ ОТТЕНКА



Apprezzabili differenze nell'aspetto di superficie e grafica all'interno della stessa produzione / Clearly distinguishable differences in texture and pattern within the same production run / Auffällige Unterschiede in Aussehen und Struktur innerhalb der gleichen Produktionscharge / Différences visibles au niveau de l'aspect et de la fantaisie entre les carreaux du même lot de production / Diferencias visibles en el aspecto de la superficie y los motivos dentro de un mismo lote de producción / заметные отличия вида поверхности и графики в одной и той же партии

DESTINAZIONE D'USO / INTENDED USE / ANWENDUNGSBEREICH / CHAMP D'APPLICATION / USO PREVISTO / НАЗНАЧЕНИЕ

### H (Naturale/Matt, Soft, Strutturato)

Materiali consigliati per sollecitazioni all'abrasione relativamente forti in ambienti anche non protetti da agenti graffianti / Materials recommended for relatively heavy abrasion levels, also in premises not protected against abrasive substances / Materials recommended for relatively heavy abrasion levels, also in premises not protected against abrasive substances / Empfohlen für starke Abriebbeanspruchungen in Bereichen auch ohne Kratzschutzbehandlung / Matériaux recommandés pour des locaux soumis à des fortes contraintes d'abrasion, même non protégés contre les agents abrasifs / Materiales recomendados para soportar esfuerzos de abrasión relativamente intensos incluso en espacios no protegidos frente a agentes abrasivos / Материалы рекомендованы для относительно сильного абразивного воздействия, в том числе в помещениях, не защищенных от царапающих элементов

DECORI / DECORATIVE PIECES / DEKORE / DÉCORS / DECORACIONES / ДЕКОРЫ

### Muretto

Mosaico assemblato con tratto plastico / Spot-bonded mosaic / Punktverklebtes Mosaik / Mosaïque montée avec trait de colle / Mosaico colocado aplicando cola plástica / Мозаика с сегментами, выполненными из пластмассы - Мозаика, собранная на клеевой точке

### Mosaico, Realstone Mosaico Mix

Mosaico assemblato su rete in fibra di vetro / Mosaic mesh - mounted on fiberglass / Auf Glasfasernetz geklebtes Mosaik / Mosaïque montée sur filet en fibre de verre / Mosaico enmallado sobre fibra de vidrio / Мозаика, собранная на сетке из стекловолокна

### Realstone Mosaico Mix

Mix di tutti i fondi / Mixture of all plain tiles / Mischung aller Grundfliesen / Mélange de tous les fonds / Mezcla de todos los fondos / Смесь всех фоновых плиток

PEZZI SPECIALI / TRIMS / SPEZIALTEILE / PIÈCES SPÉCIALES / PIEZAS ESPECIALES / СПЕЦИАЛЬНЫЕ ИЗДЕЛИЯ

### BT.B.C.

Battiscopa Becco Civetta ottenuto da taglio del fondo / Coved Edge Skirting Tile cut from plain tile / Sockelleiste, Halbrundstab, aus Grundfliese geschnitten / Plinthe bord rond découpée dans le fond / Rodapié canto romo conseguido mediante corte del fondo / Плинтус с закругленным краем, полученный из фоновой плитки

### E.Elle

Elemento ad Elle tagliato ed assemblato / Two-piece L-Tile / Schenkelplatte, geschnitten und zusammengesetzt / Élément en L coupé et assemblé / Elemento en forma de "L" cortado y montado / Г-образный элемент, состоящий из двух частей

CARATTERISTICHE / CHARACTERISTICS / EIGENSCHAFTEN / CARACTERISTIQUES / DATOS / ХАРАКТЕРИСТИКИ

	<b>R9</b> Soft	<b>PENDULUM</b>	<b>D-COF</b>	<b>BCR</b>
	<b>R10</b> Naturale/Matt	<b>classe 1</b> Soft	<b>&gt; 0,42</b>	<b>μ &gt; 0,40</b>
	<b>R11</b> Strutturato	<b>classe 2</b> Naturale/Matt		
		<b>classe 3</b> Strutturato		
		<b>ptv &gt; 36</b> Nat/Strutt		
	<b>C</b> Strutturato			
	<b>≤ 175 mm<sup>3</sup></b>			

CERTIFICAZIONI / CERTIFICATIONS / ZERTIFIZIERUNGEN / CERTIFICACIONES / СЕРТИФИКАЦИИ



IMBALLI / PACKAGING / VERPACKUNGEN / EMBALAJES / УПАКОВКИ

		scatole / box / karton / boîte / caja / коробк			pallet / pallet / palette / palette / pallet / поддон			
		□	M²	KG	□	M²	KG	+ mm
60x120	Naturale/Matt, Soft	2	1,44	31,47	36	51,84	1132,85	9,5
60x120	Strutturato	2	1,44	31,47	36	51,84	1132,85	9,5
75x75	Naturale/Matt, Soft	2	1,13	23,81	42	47,25	1000,00	9,5
60x60	Naturale/Matt, Soft	3	1,08	22,50	40	43,20	900,00	9,5
60x60	Strutturato	3	1,08	22,50	40	43,20	900,00	9,5
30x60	Naturale/Matt, Strutt	5	0,90	19,20	48	43,20	921,60	9,5
30x60	Soft	5	0,90	19,20	48	43,20	921,60	9,5
30x60	Muretto	4	0,72	19,37	27	19,44	522,95	9,5
30x30	Mosaico 3D	4	0,36	10,44	48	17,28	501,20	9,5
37x24,5	Mosaico Mix	5	0,34	5,41	54	18,37	292,10	9,5
7x60	BT.B.C.	15	9,0 ml	18,18	-	-	-	9,5
7x75	BT.B.C.	14	10,50 ml	18,42	-	-	-	9,5
15x60x4	E.ELLE	4	0,36	8,70	-	-	-	-

STONE EFFECT

# Realstone\_Jerusalem



R05A Noce 75x75 - 29<sup>1/2</sup> x 29<sup>1/2</sup>"



## Realstone\_Jerusalem

gres fine porcellanato colorato in massa - rettificato monocalibro / colorbody fine porcelain stoneware - rectified monocaliber / durchgefärbtes feinsteinzeug - rektifiziert, in einem werkmaß / grès cérame fin coloré dans la masse - rectifié monocalibre / gres porcelánico fino coloreado en toda la masa - rectificado monocalibre / гомогенный мелкозернистый керамогранит - ректифицированный монокалиберный

gruppo Bla UNI EN 14411\_G



naturale/  
matt outdoor



**60x120 cm**  
23<sup>5/8</sup> x 47<sup>1/4</sup>"  
± 9,5 mm



**75x75 cm**  
29<sup>1/2</sup> x 29<sup>1/2</sup>"  
± 9,5 mm

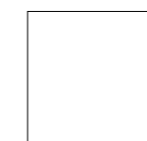

**60x60 cm**  
23<sup>5/8</sup> x 23<sup>5/8</sup>"  
± 9,5 mm



**30x60 cm**  
11<sup>13/16</sup> x 23<sup>5/8</sup>"  
± 9,5 mm

**XT20**  
Realstone\_Jerusalem XT20  
> p.418

# Realstone\_Jerusalem

60x120 - 23<sup>5/8</sup> x 47<sup>1/4</sup>" 75x75 - 29<sup>1/2</sup> x 29<sup>1/2</sup>" 60x60 - 23<sup>5/8</sup> x 23<sup>5/8</sup>" 30x60 - 11<sup>13/16</sup> x 23<sup>5/8</sup>" 37x24,5 - 14<sup>9/16</sup> x 9<sup>5/8</sup>" 30x30 - 11<sup>13/16</sup> x 11<sup>13/16</sup>"

## Avorio

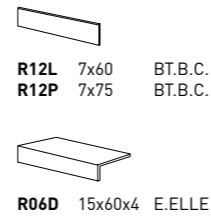

- R04V** 60x120 Rett
- R08A** 60x120 Soft Rett
- R04X** 60x120 Strutt Rett
- R057** 75x75 Rett
- R07Y** 75x75 Soft Rett
- R04Z** 60x60 Rett
- R08D** 60x60 Soft Rett
- R053** 60x60 Strutt Rett
- R05T** 30x60 Rett
- R08F** 30x60 Soft Rett
- R05V** 30x60 Strutt Rett

**R09G** 30x30 Mosaico

## Decors



**R09J** 30x30 Mosaico Avorio



**R09K** 30x30 Mosaico Noce

## Noce

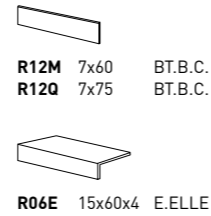

- R04W** 60x120 Rett
- R08C** 60x120 Soft Rett
- R04Y** 60x120 Strutt Rett
- R05A** 75x75 Rett
- R07Z** 75x75 Soft Rett
- R052** 60x60 Rett
- R08E** 60x60 Soft Rett
- R054** 60x60 Strutt Rett
- R05U** 30x60 Rett
- R08G** 30x60 Soft Rett
- R05W** 30x60 Strutt Rett

**R09H** 30x30 Mosaico



**R123** 30x30 Mosaico Grigio



**R12A** 37x24,5 Realstone Mosaico Mix

## Grigio

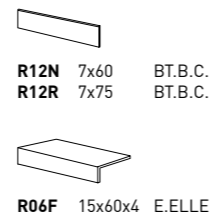

- R10D** 60x120 Rett
- R10H** 60x120 Soft Rett
- R10K** 60x120 Strutt Rett
- R0RC** 75x75 Rett
- R0W5** 75x75 Soft Rett
- R10W** 60x60 Rett
- R11W** 60x60 Soft Rett
- R11S** 60x60 Strutt Rett
- R11X** 30x60 Rett
- R11Z** 30x60 Soft Rett
- R11Y** 30x60 Strutt Rett

**R122** 30x30 Mosaico

### CONSIGLI DI POSA / INSTALLATION ADVICE / HINWEISE ZUR VERLEGUNG / CONSEILS DE POSE / SUGERENCIAS PARA LA COLOCACIÓN / РЕКОМЕНДАЦИИ ПО УКЛАДКЕ

Per le pavimentazioni esterne non protette, Ragno consiglia di creare una pendenza  $\geq 1,5\%$  sulla superficie calpestabile allo scopo di limitare il formarsi di ristagni d'acqua localizzati. Nel caso in cui questi ristagni permangano sulla superficie delle piastrelle nonostante una posa a regola d'arte, è necessario intervenire meccanicamente con l'utilizzo di scope o aspira-liquidi / For unprotected outdoor pavings, Ragno recommends the creation of a gradient of  $\geq 1.5\%$  on the finished surface, to prevent the formation of patches of standing water. In the event that standing water persists on the surface of the tiles in spite of correct installation, it must be removed mechanically with the aid of brooms or wet-and-dry vacuum cleaners / Zur Unterbindung von punktueller Stauwasserbildung bei Belägen in ungeschützten Außenbereichen, empfiehlt die Ragno die Ausbildung eines Gefälles  $\geq 1,5\%$  auf der Trittlfläche. Sollte trotz fachgerechter Verlegung Stauwasser auf der Fliesenoberfläche zurückbleiben, ist dessen mechanische Entfernung mit Hilfe eines Besens oder Nasssaugers erforderlich / Pour des sols extérieurs non protégés, Ragno conseille de créer une inclinaison  $\geq 1,5\%$  sur la surface de piétinement en vue de limiter la stagnation localisée de l'eau. Si, malgré une pose dans les règles de l'art, cette stagnation devait persister à la surface des carreaux, une intervention mécanique, au moyen de balais et d'aspirateurs de liquides, est alors nécessaire / En el caso de pavimentaciones exteriores no protegidas, Ragno recomienda crear una pendiente  $\geq 1,5\%$  en la superficie transitabile para limitar la formación de depósitos localizados de agua estancada. En caso de que estos depósitos de agua permanezcan en la superficie del azulejo, aun cuando la colocación se haya realizado correctamente, será necesario intervenir mecánicamente empleando un cepillo o un aspirador de líquidos / Для наружных незащищенных полов Ragno рекомендует создавать уклон  $\geq 1,5\%$  на пешеходной поверхности для снижения образования локальных застоев воды. В случае, если застои воды образуются на плитке несмотря на правильную укладку, необходимо прибегать к использованию механических средств, таких как щетки или же аппараты для сбора жидкостей



# Realstone\_Jerusalem



R05A Noce Rettificato 75x75 - 29<sup>1/2</sup>"x29<sup>1/2</sup>" - R12A Realstone Mosaico Mix 37x24,5 - 14<sup>9/16</sup>"x9<sup>5/8</sup>"

## TECH INFO

VARIAZIONI CROMATICHE / COLOUR VARIATIONS / FARBVARIATIONEN / VARIATIONS CHROMATIQUES / VARIACIONES CROMÁTICAS / ВАРИАНТЫ ОТТЕНКА



Apprezzabili differenze nell'aspetto di superficie e grafica all'interno della stessa produzione / Clearly distinguishable differences in texture and pattern within the same production run / Auffällige Unterschiede in Aussehen und Struktur innerhalb der gleichen Produktionscharge / Différences visibles au niveau de l'aspect et de la fantaisie entre les carreaux du même lot de production / Diferencias visibles en el aspecto de la superficie y los motivos dentro de un mismo lote de producción / заметные отличия вида поверхности и графики в одной и той же партии

DESTINAZIONE D'USO / INTENDED USE / ANWENDUNGSBEREICH / CHAMP D'APPLICATION / USO PREVISTO / НАЗНАЧЕНИЕ

### H (Naturale/Matt, Soft, Strutturato)

Materiali consigliati per sollecitazioni all'abrasione relativamente forti in ambienti anche non protetti da agenti graffianti / Materials recommended for relatively heavy abrasion levels, also in premises not protected against abrasive substances / Materials recommended for relatively heavy abrasion levels, also in premises not protected against abrasive substances / Empfohlen für starke Abriebbeanspruchungen in Bereichen auch ohne Kratzschutzbehandlung / Matériaux recommandés pour des locaux soumis à des fortes contraintes d'abrasion, même non protégés contre les agents abrasifs / Materiales recomendados para soportar esfuerzos de abrasión relativamente intensos incluso en espacios no protegidos frente a agentes abrasivos / Материалы рекомендованы для относительно сильного абразивного воздействия, в том числе в помещениях, не защищенных от царапающих элементов

DECORI / DECORATIVE PIECES / DEKORE / DÉCORS / DECORACIONES / ДЕКОРЫ

### Mosaico, Realstone Mosaico Mix

Mosaico assemblato su rete in fibra di vetro / Mosaic mesh - mounted on fibreglass / Auf Glasfasernetz geklebtes Mosaik / Mosaïque montée sur filet en fibre de verre / Mosaico enmallado sobre fibra de vidrio / Мозаика, собранная на сетке из стекловолокна

### Realstone Mosaico Mix

Mix di tutti i fondi / Mixture of all plain tiles / Mischung aller Grundfliesen / Mélange de tous les fonds / Mezcla de todos los fondos / Смесь всех фоновых плиток

PEZZI SPECIALI / TRIMS / SPEZIALTEILE / PIÈCES SPÉCIALES / PIEZAS ESPECIALES / СПЕЦИАЛЬНЫЕ ИЗДЕЛИЯ

### BT.B.C.

Battiscopa Becco Civetta ottenuto da taglio del fondo / Coved Edge Skirting Tile cut from plain tile / Sockelleiste, Halbrundstab, aus Grundfliese geschnitten / Plinthe bord rond découpée dans le fond / Rodapié canto romo conseguido mediante corte del fondo / Плинтус с закругленным краем, полученный из фоновой плитки

### E.Elle

Elemento ad Elle tagliato ed assemblato / Two-piece L-Tile / Schenkelplatte, geschnitten und zusammengesetzt / Élément en L coupé et assemblé / Elemento en forma de "L" cortado y montado / Г-образный элемент, состоящий из двух частей

CARATTERISTICHE / CHARACTERISTICS / EIGENSCHAFTEN / CARACTERISTIQUES / DATOS / ХАРАКТЕРИСТИКИ

	R9 Soft R10 Naturale/Matt R11 Strutturato	PENDULUM classe 1 Soft classe 2 Naturale/Matt classe 3 Strutturato ptv > 36 Nat/Strutt	D-COF > 0,42	BCR μ > 0,40
	C Strutturato			
	≤ 175 mm <sup>2</sup>			

CERTIFICAZIONI / CERTIFICATIONS / ZERTIFIZIERUNGEN / CERTIFICACIONES / СЕРТИФИКАЦИИ



IMBALLI / PACKAGING / VERPACKUNGEN / EMBALLAGES / EMBALAJES / УПАКОВКИ

		scatole / box / karton / boîte / caja / короб			pallet / pallet / palette / palette / pallet / поддон			
		□	M <sup>2</sup>	KG	□	M <sup>2</sup>	KG	± mm
60x120	Naturale/Matt, Soft	2	1,44	31,47	36	51,84	1132,85	9,5
60x120	Strutturato	2	1,44	31,47	36	51,84	1132,85	9,5
75x75	Naturale/Matt, Soft	2	1,13	23,81	42	47,25	1000,00	9,5
60x60	Naturale/Matt, Strutt	3	1,08	22,50	40	43,20	900,00	9,5
60x60	Soft	3	1,08	22,50	40	43,20	900,00	9,5
30x60	Naturale/Matt, Strutt	5	0,90	19,20	48	43,20	921,60	9,5
30x60	Soft	5	0,90	19,20	48	43,20	921,60	9,5
30x30	Mosaico	4	0,36	7,73	80	28,80	618,00	9,5
37x24,5	Mosaico Mix	5	0,34	5,41	54	18,37	292,10	9,5
7x60	BT.B.C.	15	9,00 ml	18,18	-	-	-	9,5
7x75	BT.B.C.	14	10,50 ml	18,42	-	-	-	9,5
15x60x4	E.ELLE	4	0,36	8,70	-	-	-	-

STONE EFFECT

# Realstone\_Quarzite



**R08W** Mosaico 3D Grigio 29x29 - 11<sup>7/16</sup>"x11<sup>7/16</sup>" - **R04E** Grigio Rettificato 60x120 - 23<sup>5/8</sup>"x47<sup>1/4</sup>"  
**R04L** Grigio Rettificato 60x60 - 23<sup>5/8</sup>"x23<sup>5/8</sup>" - **R07J** Grigio Rettificato 30x60 - 11<sup>13/16</sup>"x23<sup>5/8</sup>"

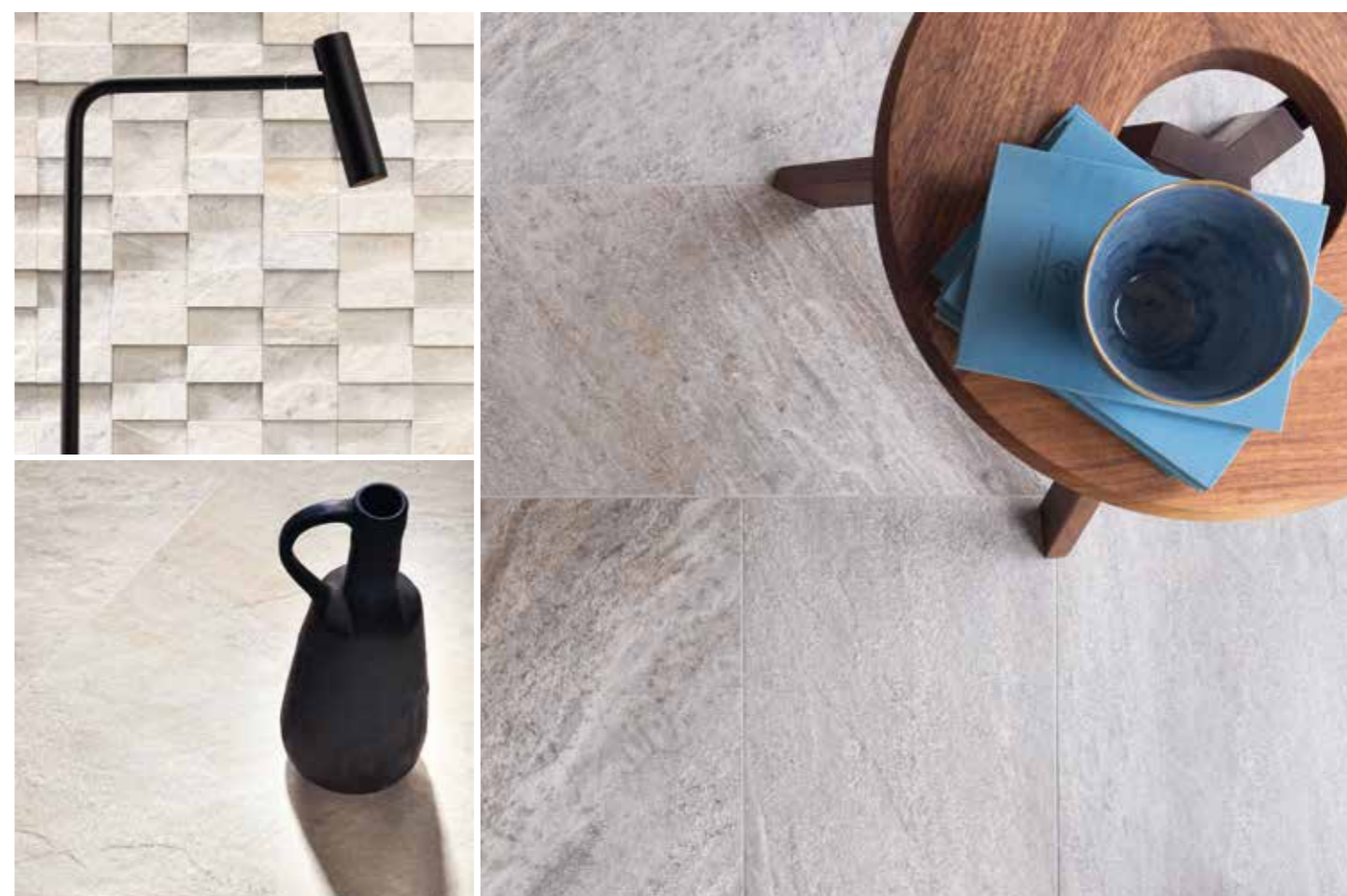

## Realstone\_Quarzite

gres fine porcellanato colorato in massa - rettificato monocalibro / colorbody fine porcelain stoneware - rectified monocaliber / durchgefärbtes feinsteinzeug - rektifiziert, in einem werkmaß / grès cérame fin coloré dans la masse - rectifié monocalibre / gres porcelánico fino coloreado en toda la masa - rectificado monocalibre / гомогенный мелкозернистый керамогранит - ректифицированный монокалиберный

gruppo Bla UNI EN 14411\_G



naturale/  
matt outdoor



**60x120 cm**  
23<sup>5/8</sup>"x47<sup>1/4</sup>"  
± 9,5 mm

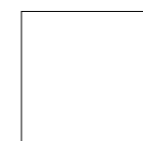

**60x60 cm**  
23<sup>5/8</sup>"x23<sup>5/8</sup>"  
± 9,5 mm



**30x60 cm**  
11<sup>13/16</sup>"x23<sup>5/8</sup>"  
± 9,5 mm

**XT20**  
**Realstone\_Quarzite XT20**  
> p.422

# Realstone\_Quarzite

60x120 - 23<sup>5/8</sup>"x47<sup>1/4</sup>" 60x60 - 23<sup>5/8</sup>"x23<sup>5/8</sup>" 30x60 - 11<sup>13/16</sup>"x23<sup>5/8</sup>" 29x29 - 11<sup>7/16</sup>"x11<sup>7/16</sup>" 15x30 - 5<sup>7/8</sup>"x11<sup>13/16</sup>"

## Bianco



- R04G** 60x120 Rett
- R07T** 60x120 Soft Rett
- R04K** 60x120 Strutt Rett
- R04N** 60x60 Rett
- R07V** 60x60 Soft Rett
- R04R** 60x60 Strutt Rett
- R07K** 30x60 Rett
- R07X** 30x60 Soft Rett
- R07M** 30x60 Strutt Rett



**R08X** 29x29 Mosaico 3D



**R12K** 7x60 BT.B.C.

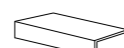

**R06C** 15x60x4 E.ELLE

## Grigio



- R04E** 60x120 Rett
- R07S** 60x120 Soft Rett
- R04H** 60x120 Strutt Rett
- R04L** 60x60 Rett
- R07U** 60x60 Soft Rett
- R04P** 60x60 Strutt Rett
- R07J** 30x60 Rett
- R07W** 30x60 Soft Rett
- R07L** 30x60 Strutt Rett



**R08W** 29x29 Mosaico 3D



**R12J** 7x60 BT.B.C.

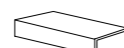

**R03K** 15x60x4 E.ELLE

## Decors



**R08Z** 30x60 Muretto Bianco



**R08Y** 30x60 Muretto Grigio



**R12A** 37x24,5 Realstone Mosaico Mix

### CONSIGLI DI POSA / INSTALLATION ADVICE / HINWEISE ZUR VERLEGUNG / CONSEILS DE POSE / SUGERENCIAS PARA LA COLOCACIÓN / РЕКОМЕНДАЦИИ ПО УКЛАДКЕ

Per le pavimentazioni esterne non protette, Ragno consiglia di creare una pendenza  $\geq 1,5\%$  sulla superficie calpestabile allo scopo di limitare il formarsi di ristagni d'acqua localizzati. Nel caso in cui questi ristagni permangano sulla superficie delle piastrelle nonostante una posa a regola d'arte, è necessario intervenire meccanicamente con l'utilizzo di scope o aspira-liquidi / For unprotected outdoor pavings, Ragno recommends the creation of a gradient of  $\geq 1.5\%$  on the finished surface, to prevent the formation of patches of standing water. In the event that standing water persists on the surface of the tiles in spite of correct installation, it must be removed mechanically with the aid of brooms or wet-and-dry vacuum cleaners / Zur Unterbindung von punktueller Stauwasserbildung bei Belägen in ungeschützten Außenbereichen, empfiehlt die Ragno die Ausbildung eines Gefälles  $\geq 1,5\%$  auf der Trittlfläche. Sollte trotz fachgerechter Verlegung Stauwasser auf der Fliesenoberfläche zurückbleiben, ist dessen mechanische Entfernung mit Hilfe eines Besens oder Nasssaugers erforderlich / Pour des sols extérieurs non protégés, Ragno conseille de créer une inclinaison  $\geq 1,5\%$  sur la surface de piétinement en vue de limiter la stagnation localisée de l'eau. Si, malgré une pose dans les règles de l'art, cette stagnation devait persister à la surface des carreaux, une intervention mécanique, au moyen de balais et d'aspirateurs de liquides, est alors nécessaire / En el caso de pavimentaciones exteriores no protegidas, Ragno recomienda crear una pendiente  $\geq 1,5\%$  en la superficie transitabile para limitar la formación de depósitos localizados de agua estancada. En caso de que estos depósitos de agua permanezcan en la superficie del azulejo, aun cuando la colocación se haya realizado correctamente, será necesario intervenir mecánicamente empleando un cepillo o un aspirador de líquidos / Для наружных незащищенных полов Ragno рекомендует создавать уклон  $\geq 1,5\%$  на пешеходной поверхности для снижения образования локальных застоев воды. В случае, если застои воды образуются на плитке несмотря на правильную укладку, необходимо прибегать к использованию механических средств, таких как щетки или же аппараты для сбора жидкостей

# Realstone\_Quarzite



REALSTONE\_QUARZITE | STONE EFFECT

REALSTONE\_QUARZITE | STONE EFFECT

R04E Grigio Rettificato 60x120 - 23<sup>5/8</sup>"x47<sup>1/4</sup>" - R08Y Muretto Grigio 30x60 - 11<sup>13/16</sup>"x23<sup>5/8</sup>"

## TECH INFO

VARIAZIONI CROMATICHE / COLOUR VARIATIONS / FARBVARIATIONEN / VARIACIONES CROMATICAS / ВАРИАНТЫ ОТТЕНКА



Significativa variazione di aspetto superficiale, grafica e colore da piastrella a piastrella e all'interno della stessa piastrella. Si consiglia di visionare la gamma cromatica prima della selezione del materiale / Significant variation in texture, pattern and colour from tile to tile within the same production run. The colour range should be viewed before selecting the material / Bedeutende Variation in Aussehen, Struktur und Farbe von Fliese zu Fliese und in ein und derselben Fliese. Es wird empfohlen, das Farbsortiment vor der Auswahl des Materials zu prüfen / Variation significative au niveau de l'aspect, de la fantaisie et de la couleur entre les carreaux et au sein d'un même carreau. Il est recommandé de consulter la gamme des couleurs avant de sélectionner le matériel / Variación considerable en el aspecto superficial, los motivos y el color entre un azulejo y otro y dentro del propio azulejo. Es aconsejable visualizar la gama cromática antes de seleccionar el material / Значительные отличия вида поверхности, графики и цвета у разных плиток и на одной и той же плитке. Перед отбором материала рекомендуется посмотреть цветовую гамму

DESTINAZIONE D'USO / INTENDED USE / ANWENDUNGSBEREICH / CHAMP D'APPLICATION / USO PREVISTO / НАЗНАЧЕНИЕ

### H (Naturale/Matt, Soft, Strutturato)

Materiali consigliati per sollecitazioni all'abrasione relativamente forti in ambienti anche non protetti da agenti graffianti / Materials recommended for relatively heavy abrasion levels, also in premises not protected against abrasive substances / Materials recommended for relatively heavy abrasion levels, also in premises not protected against abrasive substances / Empfohlen für starke Abriebbeanspruchungen in Bereichen auch ohne Kratzschutzbehandlung / Matériaux recommandés pour des locaux soumis à des fortes contraintes d'abrasion, même non protégés contre les agents abrasifs / Materiales recomendados para soportar esfuerzos de abrasión relativamente intensos incluso en espacios no protegidos frente a agentes abrasivos / Материалы рекомендованы для относительно сильного абразивного воздействия, в том числе в помещениях, не защищенных от царапающих элементов

DECORI / DECORATIVE PIECES / DEKORE / DÉCORS / DECORACIONES / ДЕКОРЫ

### Mosaico 3D

Mosaico assemblato con resina / Resin-bonded mosaic / Harzverklebtes Mosaik / Mosaïque montée avec résine / Mezcla de todos los fondos / Смесь всех фоновых плиток

### Muretto

Mosaico assemblato con tratto plastico / Spot-bonded mosaic / Punktverklebtes Mosaik / Mosaïque montée avec trait de colle / Mosaico colocado aplicando cola plástica / Мозаика с сегментами, выполненными из пластмассы - Мозаика, собранная на клеевой точке

### Realstone Mosaico Mix

Mosaico assemblato su rete in fibra di vetro / Mosaic mesh - mounted on fibreglass / Auf Glasfasernetz geklebtes Mosaik / Mosaïque montée sur filet en fibre de verre / Mosaico enmallado sobre fibra de vidrio / Мозаика, собранная на сетке из стекловолокна  
Mix di tutti i fondi / Mixture of all plain tiles / Mischung aller Grundfliesen / Mélange de tous les fonds / Mezcla de todos los fondos / Смесь всех фоновых плиток

PEZZI SPECIALI / TRIMS / SPEZIALTEILE / PIÈCES SPÉCIALES / PIEZAS ESPECIALES / СПЕЦИАЛЬНЫЕ ИЗДЕЛИЯ

### BT.B.C.

Battiscopa Becco Civetta ottenuto da taglio del fondo / Coved Edge Skirting Tile cut from plain tile / Sockelleiste, Halbrundstab, aus Grundfliese geschnitten / Plinthe bord rond découpée dans le fond / Rodapié canto romo conseguido mediante corte del fondo / Плинтус с закругленным краем, полученный из фоновой плитки

### E.Elle

Elemento ad Elle tagliato ed assemblato / Two-piece L-Tile / Schenkelplatte, geschnitten und zusammengesetzt / Élément en L coupé et assemblé / Elemento en forma de "L" cortado y montado / Г-образный элемент, состоящий из двух частей

CARATTERISTICHE / CHARACTERISTICS / EIGENSCHAFTEN / CARACTERISTIQUES / DATOS / ХАРАКТЕРИСТИКИ

	R9 Soft	PENDULUM	D-COF	BCR
	R10 Naturale/Matt	classe 1 Soft	> 0,42	μ > 0,40
	R11 Strutturato	classe 2 Naturale/Matt classe 3 Strutturato		
		ptv > 36 Nat/Strutt		
	C Strutturato			
	≤ 175 mm <sup>2</sup>			

CERTIFICAZIONI / CERTIFICATIONS / ZERTIFIZIERUNGEN / CERTIFICACIONES / СЕРТИФИКАЦИИ



IMBALLI / PACKAGING / VERPACKUNGEN / EMBALLAGES / EMBALAJES / УПАКОВКИ

		scatole / box / karton / boîte / caja / короб			pallet / pallet / palette / palette / pallet / поддон			
		□	M <sup>2</sup>	KG	□	M <sup>2</sup>	KG	± mm
60x120	Naturale/Matt, Soft	2	1,44	31,47	36	51,84	1132,85	9,5
60x120	Strutturato	2	1,44	31,47	36	51,84	1132,85	9,5
60x60	Naturale/Matt, Strutt	3	1,08	22,50	40	43,20	900,00	9,5
60x60	Soft	3	1,08	22,50	40	43,20	900,00	9,5
30x60		5	0,90	19,20	48	43,20	921,60	9,5
30x60	Muretto	4	0,72	19,37	27	19,44	522,96	9,5
29x29	Mosaico 3D	4	0,34	7,83	48	16,15	360,00	9,5
37x24,5	Mosaico Mix	5	0,34	5,41	54	18,37	292,10	9,5
7x60	BT.B.C.	15	9,00 ml	18,18	-	-	-	9,5
15x60x4	E.ELLE	4	0,36	8,70	-	-	-	-

STONE EFFECT

# Stoneway\_Ardesia



R55F Grigio Rettificato 60x60 - 23<sup>5/8</sup>"x23<sup>5/8</sup>" - R5VY Mosaico Freccia Grigio 30x36 - 11<sup>13/16</sup>"x14<sup>3/16</sup>"



## Stoneway\_Ardesia

gres porcellanato / porcelain stoneware / feinsteinzeug / grès cérame émaillé / gres porcelánico / керамогранит  
 gruppo Bia UNI EN 14411\_G



naturale/  
matt outdoor



60x60 cm  
23<sup>5/8</sup>"x23<sup>5/8</sup>"  
± 9,5 mm



30x60 cm  
11<sup>13/16</sup>"x23<sup>5/8</sup>"  
± 9,5 mm



30x30 cm  
11<sup>13/16</sup>"x11<sup>13/16</sup>"  
± 9,5 mm



20x40 cm  
7<sup>7/8</sup>"x15<sup>3/4</sup>"  
± 9 mm



20x20 cm  
7<sup>7/8</sup>"x7<sup>7/8</sup>"  
± 9 mm

XT20  
Stoneway\_Ardesia XT20  
> p.426

# Stoneway\_Ardesia

60x60 - 23<sup>5/8</sup> x 23<sup>5/8</sup> 30x60 - 11<sup>13/16</sup> x 23<sup>5/8</sup> 30x36 - 11<sup>13/16</sup> x 14<sup>3/16</sup> 30x30 - 11<sup>13/16</sup> x 11<sup>13/16</sup> 20x40 - 7<sup>7/8</sup> x 15<sup>3/4</sup> 20x20 - 7<sup>7/8</sup> x 7<sup>7/8</sup>

## Bianco



**R5SE** 60x60 Rett  
**R5SN** 60x60 Strutt Rett  
**R5SJ** 30x60 Rett  
**R5SW** 30x60 Strutt Rett  
**R5SS** 30x30 Strutt Rett  
**R5JU** 20x40 Strutt  
**R5JQ** 20x20 Strutt



**R5VT** 29x29 Mosaico



**R5VA** 7x60 BT.B.C.  
**R5VF** 7x60 BT.B.C. Strutt



**R5VK** 15x60x4 E.ELLE Strutt  
**R5VP** 20x40x4 E.ELLE Strutt

## Beige



**R5SG** 60x60 Rett  
**R5SQ** 60x60 Strutt Rett  
**R5SL** 30x60 Rett  
**R5SY** 30x60 Strutt Rett  
**R5SU** 30x30 Strutt Rett  
**R5JW** 20x40 Strutt  
**R5JS** 20x20 Strutt



**R5VV** 29x29 Mosaico



**R5VD** 7x60 BT.B.C.  
**R5VH** 7x60 BT.B.C. Strutt



**R5VM** 15x60x4 E.ELLE Strutt  
**R5VR** 20x40x4 E.ELLE Strutt

## Grigio



**R5SF** 60x60 Rett  
**R5SP** 60x60 Strutt Rett  
**R5SK** 30x60 Rett  
**R5SX** 30x60 Strutt Rett  
**R5ST** 30x30 Strutt Rett  
**R5JV** 20x40 Strutt  
**R5JR** 20x20 Strutt



**R5VU** 29x29 Mosaico



**R5VC** 7x60 BT.B.C.  
**R5VG** 7x60 BT.B.C. Strutt



**R5VL** 15x60x4 E.ELLE Strutt  
**R5VQ** 20x40x4 E.ELLE Strutt

## Decors



**R5VX** 30x36 Mosaico Freccia Bianco



**R5VY** 30x36 Mosaico Freccia Grigio



**R5WA** 30x36 Mosaico Freccia Antracite



**R5VZ** 30x36 Mosaico Freccia Beige

## Antracite



**R5SH** 60x60 Rett  
**R5SR** 60x60 Strutt Rett  
**R5SM** 30x60 Rett  
**R5SZ** 30x60 Strutt Rett  
**R5SV** 30x30 Strutt Rett  
**R5JX** 20x40 Strutt  
**R5JT** 20x20 Strutt

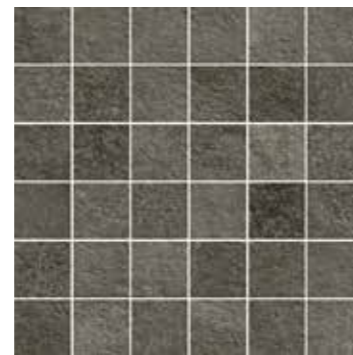

**R5VW** 29x29 Mosaico



**R5VE** 7x60 BT.B.C.  
**R5VJ** 7x60 BT.B.C. Strutt



**R5VN** 15x60x4 E.ELLE Strutt  
**R5VS** 20x40x4 E.ELLE Strutt

# Stoneway\_Ardesia



STONWAY\_ARDESIA | STONE EFFECT

STONWAY\_ARDESIA | STONE EFFECT

R55N Bianco Strutturato Rettificato 60x60 - 23<sup>5/8</sup>"x23<sup>5/8</sup>" - R55W Bianco Strutturato Rettificato 30x60 - 11<sup>13/16</sup>"x23<sup>5/8</sup>" - R55S Bianco Strutturato Rettificato 30x30 - 11<sup>13/16</sup>"x11<sup>13/16</sup>"

## TECH INFO

VARIAZIONI CROMATICHE / COLOUR VARIATIONS / FARBVARIATIONEN / VARIATIONS CHROMATIQUES / VARIACIONES CROMÁTICAS / ВАРИАНТЫ ОТТЕНКА

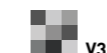

Significativa variazione di aspetto superficiale, grafica e colore da piastrella a piastrella e all'interno della stessa piastrella. Si consiglia di visionare la gamma cromatica prima della selezione del materiale / Significant variation in texture, pattern and colour from tile to tile within the same production run. The colour range should be viewed before selecting the material / Bedeutende Variation in Aussehen, Struktur und Farbe von Fliese zu Fliese und in ein und derselben Fliese. Es wird empfohlen, das Farbsortiment vor der Auswahl des Materials zu prüfen / Variation significative au niveau de l'aspect, de la fantaisie et de la couleur entre les carreaux et au sein d'un même carreau. Il est recommandé de consulter la gamme des couleurs avant de sélectionner le matériel / Variación considerable en el aspecto superficial, los motivos y el color entre un azulejo y otro y dentro del propio azulejo. Es aconsejable visualizar la gama cromática antes de seleccionar el material / Значительные отличия вида поверхности, графики и цвета у разных плиток и на одной и той же плитке. Перед отбором материала рекомендуется посмотреть цветовую гамму

DESTINAZIONE D'USO / INTENDED USE / ANWENDUNGSBEREICH / CHAMP D'APPLICATION / USO PREVISTO / НАЗНАЧЕНИЕ

### H (Naturale/Matt, Strutturato)

Materiali consigliati per sollecitazioni all'abrasione relativamente forti in ambienti anche non protetti da agenti graffianti / Materials recommended for relatively heavy abrasion levels, also in premises not protected against abrasive substances / Materials recommended for relatively heavy abrasion levels, also in premises not protected against abrasive substances / Empfohlen für starke Abriebbeanspruchungen in Bereichen auch ohne Kratzschutzbehandlung / Matériaux recommandés pour des locaux soumis à des fortes contraintes d'abrasion, même non protégés contre les agents abrasifs / Materiales recomendados para soportar esfuerzos de abrasión relativamente intensos incluso en espacios no protegidos frente a agentes abrasivos / Материалы рекомендованы для относительно сильного абразивного воздействия, в том числе в помещениях, не защищенных от царапающих элементов

DECORI / DECORATIVE PIECES / DEKORE / DÉCORS / DECORACIONES / ДЕКОРЫ

### Mosaico, Mosaico Freccia

Mosaico assemblato con tratto plastico / Spot-bonded mosaic / Punktverklebtes Mosaik / Mosaïque montée avec trait de colle / Mosaico colocado aplicando cola plástica / Мозаика с сегментами, выполненными из пластмассы - Мозаика, собранная на клеевой точке

PEZZI SPECIALI / TRIMS / SPEZIALTEILE / PIÈCES SPÉCIALES / PIEZAS ESPECIALES / СПЕЦИАЛЬНЫЕ ИЗДЕЛИЯ

### BT.B.C.

Battiscopa Becco Civetta ottenuto da taglio del fondo / Coved Edge Skirting Tile cut from plain tile / Sockelleiste, Halbrundstab, aus Grundfliese geschnitten / Plinthe bord rond découpée dans le fond / Rodapié canto romo conseguido mediante corte del fondo / Плинтус с закругленным краем, полученный из фоновой плитки

### E.Elle

Elemento ad Elle tagliato ed assemblato / Two-piece L-Tile / Schenkelplatte, geschnitten und zusammengesetzt / Élément en L coupé et assemblé / Elemento en forma de "L" cortado y montado / Г-образный элемент, состоящий из двух частей

CARATTERISTICHE / CHARACTERISTICS / EIGENSCHAFTEN / CARACTERISTIQUES / DATOS / ХАРАКТЕРИСТИКИ

	<b>R10</b> Naturale/Matt <b>R11</b> Strutturato	<b>PENDULUM</b> <b>classe 1</b> Naturale/Matt <b>classe 3</b> Strutturato <b>ptv &gt; 36</b> Strutturato	<b>D-COF</b> <b>&gt; 0,42</b>	<b>BCR</b> <b>μ &gt; 0,40</b>
	<b>C</b> Strutturato			
	<b>≤ 175 mm²</b>			

CERTIFICAZIONI / CERTIFICATIONS / ZERTIFIZIERUNGEN / CERTIFICACIONES / СЕРТИФИКАЦИИ



IMBALLI / PACKAGING / VERPACKUNGEN / EMBALLAGES / EMBALAJES / УПАКОВКИ

		scatole / box / karton / boîte / caja / короб			pallet / pallet / palette / palette / pallet / поддон			
			<b>M²</b>	<b>KG</b>		<b>M²</b>	<b>KG</b>	<b>± mm</b>
60x60	Rettificato	3	1,08	22,50	40	43,20	900,00	9,5
60x60	Strutturato Rettificato	3	1,08	22,50	40	43,20	900,00	9,5
30x60	Rett. Strutt Rett	6	1,08	23,04	48	51,84	1105,80	9,5
30x30	Strutturato Rettificato	12	1,08	11,52	40	43,20	552,90	9,5
20x40	Strutturato	13	1,04	19,35	54	56,16	1045,03	9
20x20	Strutturato	26	1,04	17,74	54	56,16	957,71	9
30x30	Mosaico	4	0,36	7,29	80	28,80	583,67	9,5
30x36	Mosaico Freccia	4	0,43	11,38	60	25,92	682,99	9,5
7x60	BT.B.C.	15	9,0 ml	13,99	-	-	-	9,5
7x60	BT.B.C. Strutt	15	9,0 ml	13,99	-	-	-	9,5
15x60x4	E.ELLE Strutt	4	0,36	8,00	-	-	-	-
20x40x4	E.ELLE Strutt	6	0,48	12,00	-	-	-	-

STONE EFFECT

# Stoneway\_Barge Antica



R3NX Grigio Rettificato 60x60 - 23<sup>5/8</sup>"x23<sup>5/8</sup>" - R3P4 Grigio Rettificato 30x60 - 11<sup>13/16</sup>"x23<sup>5/8</sup>" - R3QA Mosaico Grigio 30x30 - 11<sup>13/16</sup>"x11<sup>13/16</sup>"



## Stoneway\_Barge Antica

rectified outdoor 60x60 - 30x60  
rectified 60x60 - 30x60 - 15x60  
gres porcellanato - rettificato monocalibro / porcelain stoneware - rectified monocaliber / feinsteinzeug - rektifiziert, in einem werkmaß / grès cérame émaillé - rectifié monocalibre / gres porcelánico - rectificado monocalibre / керамогранит - ректифицированный монокалиберный  
outdoor 20x40 - 20x20  
gres porcellanato / porcelain stoneware / feinsteinzeug / grès cérame émaillé / gres porcelánico / керамогранит  
gruppo Bla UNI EN 14411\_G

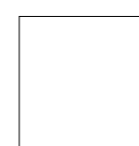

60x60 cm  
23<sup>5/8</sup>"x23<sup>5/8</sup>"  
± 9,5 mm



30x60 cm  
11<sup>13/16</sup>"x23<sup>5/8</sup>"  
± 9,5 mm



15x60 cm  
5<sup>7/8</sup>"x23<sup>5/8</sup>"  
± 9,5 mm



20x40 cm  
7<sup>7/8</sup>"x15<sup>3/4</sup>"  
± 9 mm



20x20 cm  
7<sup>7/8</sup>"x7<sup>7/8</sup>"  
± 9 mm

XT20  
Stoneway\_Barge Antica XT20  
> p.430



# Stoneway\_Barge Antica

60x60 - 23<sup>5/8</sup> x 23<sup>5/8</sup> 30x60 - 11<sup>13/16</sup> x 23<sup>5/8</sup> 15x60 - 5<sup>7/8</sup> x 23<sup>5/8</sup> 30x30 - 11<sup>13/16</sup> x 11<sup>13/16</sup> 20x40 - 7<sup>7/8</sup> x 15<sup>3/4</sup> 20x20 - 7<sup>7/8</sup> x 7<sup>7/8</sup>

## Bianco



<b>R3NY</b>	60x60	Rett
<b>R3PE</b>	60x60	Strutt Rett
<b>R3PA</b>	30x60	Rett
<b>R3PH</b>	30x60	Strutt Rett
<b>R4FF</b>	15x60	Rett
<b>R45Y</b>	20x40	Strutt
<b>R45V</b>	20x20	Strutt



**R3QC** 30x30 Mosaico



**R3PV** 7x60 BT.B.C.  
**R46Q** 7x60 BT.B.C.  
Indoor

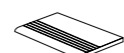

**R3PY** 30x60 SC.B.C.

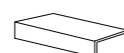

**R3QF** 15x60x4 E.ELLE  
**R468** 20x40x4 E.ELLE

## Beige



<b>R3NZ</b>	60x60	Rett
<b>R3PF</b>	60x60	Strutt Rett
<b>R3PC</b>	30x60	Rett
<b>R3PJ</b>	30x60	Strutt Rett
<b>R4FH</b>	15x60	Rett
<b>R45Z</b>	20x40	Strutt
<b>R45W</b>	20x20	Strutt



**R3QD** 30x30 Mosaico



**R3PW** 7x60 BT.B.C.  
**R46R** 7x60 BT.B.C.  
Indoor

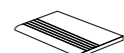

**R3PZ** 30x60 SC.B.C.



**R3QG** 15x60x4 E.ELLE  
**R46A** 20x40x4 E.ELLE

## Grigio



<b>R3NX</b>	60x60	Rett
<b>R3PD</b>	60x60	Strutt Rett
<b>R3P4</b>	30x60	Rett
<b>R3PG</b>	30x60	Strutt Rett
<b>R4FG</b>	15x60	Rett
<b>R465</b>	20x40	Strutt
<b>R45X</b>	20x20	Strutt



**R3QA** 30x30 Mosaico



**R3PU** 7x60 BT.B.C.  
**R46S** 7x60 BT.B.C.  
Indoor

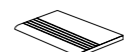

**R3PX** 30x60 SC.B.C.



**R30E** 15x60x4 E.ELLE  
**R46C** 20x40x4 E.ELLE



CONSIGLI DI POSA / INSTALLATION ADVICE / HINWEISE ZUR VERLEGUNG / CONSEILS DE POSE / SUGERENCIAS PARA LA COLOCACIÓN / РЕКОМЕНДАЦИИ ПО УКЛАДКЕ

I formati 60x60 e 30x60 rettificati sono modulari se posati con fuga 2 mm / The 60x60 and 30x60 rectified sizes can be used in modular combinations if laid with 2 mm joint / Die rektifizierten Formate 60x60 und 30x60 sind bei Verlegung mit 2-mm-Fuge modular / Les formats 60x60 et 30x60 rectifiés peuvent se combiner s'ils sont posés avec un joint de 2 mm / Los formatos de 60 x 60 rectificados son modulares si se colocan dejando juntas de 2 mm / Обрезные форматы 60x60 и 30x60 могут укладываться модульно со швом 2 мм

Per le pavimentazioni esterne non protette, Ragno consiglia di creare una pendenza  $\geq 1,5\%$  sulla superficie calpestabile allo scopo di limitare il formarsi di ristagni d'acqua localizzati. Nel caso in cui questi ristagni permangano sulla superficie delle piastrelle nonostante una posa a regola d'arte, è necessario intervenire meccanicamente con l'utilizzo di scope o aspira-liquidi / For unprotected outdoor pavings, Ragno recommends the creation of a gradient of  $\geq 1.5\%$  on the finished surface, to prevent the formation of patches of standing water. In the event that standing water persists on the surface of the tiles in spite of correct installation, it must be removed mechanically with the aid of brooms or wet-and-dry vacuum cleaners / Zur Unterbindung von punktueller Stauwasserbildung bei Belägen in ungeschützten Außenbereichen, empfiehlt die Ragno die Ausbildung eines Gefälles  $\geq 1,5\%$  auf der Trittlfläche. Sollte trotz fachgerechter Verlegung Stauwasser auf der Fliesenoberfläche zurückbleiben, ist dessen mechanische Entfernung mit Hilfe eines Besens oder Nasssaugers erforderlich / Pour des sols extérieurs non protégés, Ragno conseille de créer une inclinaison  $\geq 1,5\%$  sur la surface de piétinement en vue de limiter la stagnation localisée de l'eau. Si, malgré une pose dans les règles de l'art, cette stagnation devait persister à la surface des carreaux, une intervention mécanique, au moyen de balais et d'aspirateurs de liquides, est alors nécessaire / En el caso de pavimentaciones exteriores no protegidas, Ragno recomienda crear una pendiente  $\geq 1,5\%$  en la superficie transitabile para limitar la formación de depósitos localizados de agua estancada. En caso de que estos depósitos de agua permanezcan en la superficie del azulejo, aun cuando la colocación se haya realizado correctamente, será necesario intervenir mecánicamente empleando un cepillo o un aspirador de líquidos / Для наружных незащищенных полов Ragno рекомендует создавать уклон  $\geq 1,5\%$  на пешеходной поверхности для снижения образования локальных застоев воды. В случае, если застои воды образуются на плитке несмотря на правильную укладку, необходимо прибегать к использованию механических средств, таких как щетки или же аппараты для сбора жидкостей

# Stoneway\_Barge Antica



R3NY Bianco Rettificato 60x60 - 23<sup>9/8</sup> x 23<sup>9/8</sup> - R3QC Mosaico Bianco 30x30 - 11<sup>13/16</sup> x 11<sup>13/16</sup> - R45Y Bianco Strutturato 20x40 - 7<sup>7/8</sup> x 15<sup>3/4</sup>

## TECH INFO

VARIAZIONI CROMATICHE / COLOUR VARIATIONS / FARBVARIATIONEN / VARIATIONS CHROMATIQUES / VARIACIONES CROMÁTICAS / ВАРИАНТЫ ОТТЕККА



V4

Variazioni irregolari da piastrella a piastrella. Una piastrella può differire totalmente nell'aspetto superficiale e colore da un'altra. Si consiglia divisionare la gamma cromatica prima della selezione del materiale / Random differences from tile to tile. One tile may have totally different texture and colour from another. The colour range should be viewed before selecting the material / Wesentliche Variationen von Fliese zu Fliese. Eine Fliese kann sich in Aussehen und Farbe komplett von einer anderen unterscheiden. Es wird empfohlen, das Farbsortiment vor der Auswahl des Materials zu prüfen / Variations irrégulières entre les carreaux. L'aspect et la couleur peuvent être complètement différents d'un carreau à l'autre. Il est recommandé de consulter la gamme des couleurs avant de sélectionner le matériel / Variaciones irregulares entre un azulejo y otro. Un azulejo puede ser completamente diferente de otro en el aspecto superficial y el color. Es aconsejable visualizar la gama cromática antes de seleccionar el material / Неоднородные изменения на разных плитках. Каждая плитка может полностью отличаться по виду поверхности и цвету от другой. Перед отбором материала рекомендуется посмотреть цветовую гамму

DESTINAZIONE D'USO / INTENDED USE / ANWENDBEREICH / CHAMP D'APPLICATION / USO PREVISTO / НАЗНАЧЕНИЕ

### G (Naturale/Matt)

Materiali consigliati per locali sottoposti a sollecitazioni all'abrasione medio pesanti come: case individuali, commerciale leggero / Materials recommended for premises with medium-heavy abrasion levels, such as: detached homes, light-traffic commercial premises / Empfohlen für Räume mit mittelschwerer Abriebbeanspruchung wie: Einfamilienhäuser, leicht beanspruchte Gewerbebereiche / Matériaux recommandés pour des locaux soumis à des contraintes d'abrasion moyennes et fortes comme : maisons particulières, espaces commerciaux soumis à un trafic léger, etc / Materiales recomendados para locales sometidos a esfuerzos de abrasión medio-pesados, como casas unifamiliares y locales comerciales de tráfico ligero / Материалы рекомендованы для использования в частных домах и коммерческих помещениях, подверженных средне-сильному абразивному воздействию

### H (Strutturato)

Materiali consigliati per sollecitazioni all'abrasione relativamente forti in ambienti anche non protetti da agenti graffianti / Materials recommended for relatively heavy abrasion levels, also in premises not protected against abrasive substances / Materials recommended for relatively heavy abrasion levels, also in premises not protected against abrasive substances / Empfohlen für starke Abriebbeanspruchungen in Bereichen auch ohne Kratzschutzbehandlung / Matériaux recommandés pour des locaux soumis à des fortes contraintes d'abrasion, même non protégés contre les agents abrasifs / Materiales recomendados para soportar esfuerzos de abrasión relativamente intensos incluso en espacios no protegidos frente a agentes abrasivos / Материалы рекомендованы для относительно сильного абразивного воздействия, в том числе в помещениях, не защищенных от царапающих элементов

DECORI / DECORATIVE PIECES / DEKORE / DÉCORS / DECORACIONES / ДЕКОРЫ

### Mosaico

Mosaico assemblato su rete in fibra di vetro / Mosaic mesh - mounted on fiberglass / Auf Glasfasernetz geklebtes Mosaik / Mosaïque montée sur filet en fibre de verre / Mosaico enmallado sobre fibra de vidrio / Мозаика, собранная на сетке из стекловолокна

PEZZI SPECIALI / TRIMS / SPEZIALTEILE / PIÈCES SPÉCIALES / PIEZAS ESPECIALES / СПЕЦИАЛЬНЫЕ ИЗДЕЛИЯ

### BT.B.C.

Battiscopa Becco Civetta ottenuto da taglio del fondo / Coved Edge Skirting Tile cut from plain tile / Sockelleiste, Halbrundstab, aus Grundfliese geschnitten / Plinthe bord rond découpée dans le fond / Rodapié canto romo conseguido mediante corte del fondo / Плинтус с закругленным краем, полученный из фоновой плитки

### SC.B.C.

Righe incise con becco civetta smaltato / Scored stripes with glazed coved edge / Randstein mit eingefrästen Rillen und glasiertem Halbrundstab / Bandes gravées avec bord rond émaillé / Rayas grabadas con canto romo esmaltado / С нарезными полосками и глазурированным закругленным краем

### E.Elle

Elemento ad Elle tagliato ed assemblato / Two-piece L-Tile / Schenkelplatte, geschnitten und zusammengesetzt / Élément en L coupé et assemblé / Elemento en forma de "L" cortado y montado / Г-образный элемент, состоящий из двух частей

CARATTERISTICHE / CHARACTERISTICS / EIGENSCHAFTEN / CARACTERISTIQUES / DATOS / ХАРАКТЕРИСТИКИ

	R9 Naturale/Matt	<b>PENDULUM</b> classe 1 Naturale/Matt classe 3 Strutt Rett, Strutturato ptv > 36 Strutt Rett, Strutturato	<b>BCR</b> μ > 0,40 Strutt Rett, Strutturato
	R11 Strutt Rett, Strutturato		
	B Strutturato		
	C Strutt Rett		
	≤ 175 mm <sup>2</sup>		
	Strutt Rett, Strutturato		

CERTIFICAZIONI / CERTIFICATIONS / ZERTIFIZIERUNGEN / CERTIFICACIONES / СЕРТИФИКАЦИИ



IMBALLI / PACKAGING / VERPACKUNGEN / EMBALLAGES / EMBALAJES / УПАКОВКИ

		scatole / box / karton / boîte / caja / коробк			pallet / pallet / palette / palette / pallet / поддон			
		□	M <sup>2</sup>	KG	□	M <sup>2</sup>	KG	± mm
60x60	Rettificato	3	1,08	23,00	40	43,20	956,00	9,5
60x60	Strutturato Rettificato	3	1,08	22,88	40	43,20	915,55	9,5
30x60	Rettificato	5	0,90	18,00	48	43,20	895,00	9,5
30x60	Strutturato Rettificato	5	0,90	20,50	48	43,20	984,27	9,5
15x60	Rettificato	8	0,72	15,73	64	46,08	1006,94	9,5
20x40	Strutturato	13	1,04	19,77	54	56,16	1067,88	9
20x20	Strutturato	26	1,04	19,07	54	56,16	1029,54	9
30x30	Mosaico	4	0,36	7,29	80	28,80	583,67	10,5
7x60	BT.B.C.	14	8,40 ml	14,73	-	-	-	9,5
30x60	SC.B.C.	5	0,90	22,01	-	-	-	-
15x60x4	E.ELLE	4	0,36	5,44	-	-	-	-
20x40x4	E.ELLE	6	0,48	11,35	-	-	-	-

STONE EFFECT

# Stoneway\_Porfido



R47A Grey 30x60 - 11<sup>13/16</sup>"x23<sup>5/8</sup>"



## Stoneway\_Porfido

30x60 - XT20  
 gres fine porcellanato colorato in massa / colorbody fine porcelain stoneware / durchgefärbtes feinsteinzeug in einem werkmaß / grès cérame fin coloré dans la masse / gres porcelánico fino coloreado en toda la masa / гомогенный мелкозернистый керамогранит

30x30 - 15x30 - 15x15  
 gres porcellanato / porcelain stoneware / feinsteinzeug / grès cérame émaillé / gres porcelánico / керамогранит  
 gruppo Bia UNI EN 14411\_G



outdoor



**30x60 cm**  
 11<sup>13/16</sup>"x23<sup>5/8</sup>"  
 ± 9,5 mm



**30x30 cm**  
 11<sup>13/16</sup>"x11<sup>13/16</sup>"  
 ± 9,5 mm



**15x30 cm**  
 5<sup>7/8</sup>"x11<sup>13/16</sup>"  
 ± 9 mm



**15x15 cm**  
 5<sup>7/8</sup>"x5<sup>7/8</sup>"  
 ± 9 mm

**XT20**  
**Stoneway\_Porfido XT20**  
 > p.434

# Stoneway\_Porfido

30x60 - 11<sup>13/16</sup>"x23<sup>3/8</sup>" 30x30 - 11<sup>13/16</sup>"x11<sup>13/16</sup>" 15x30 - 5<sup>7/8</sup>"x11<sup>13/16</sup>" 15x15 - 5<sup>7/8</sup>"x5<sup>7/8</sup>"

## Ivory



R46Y 30x60  
R47F 30x30  
R47T 15x30  
R47M 15x15



R47Z 7x60 BT.B.C.

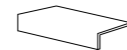

R48G 15x30x4 E.ELLE

## Black



R47E 30x60



R48F 7x60 BT.B.C.

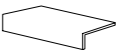

R48M 15x30x4 E.ELLE

## Grey



R47A 30x60  
R47H 30x30  
R47V 15x30  
R47P 15x15



R48C 7x60 BT.B.C.

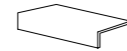

R48J 15x30x4 E.ELLE

## Beige



R46Z 30x60  
R47G 30x30  
R47U 15x30  
R47N 15x15



R48A 7x60 BT.B.C.

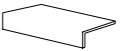

R48H 15x30x4 E.ELLE

## Anthracite



R47D 30x60  
R47K 30x30  
R47X 15x30  
R47R 15x15



R48E 7x60 BT.B.C.

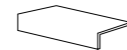

R48L 15x30x4 E.ELLE

## Rust



R47C 30x60  
R47J 30x30  
R47W 15x30  
R47Q 15x15



R48D 7x60 BT.B.C.

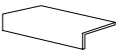

R48K 15x30x4 E.ELLE

# Stoneway\_Porfido



## TECH INFO

VARIAZIONI CROMATICHE / COLOUR VARIATIONS / FARBVARIATIONEN / VARIATIONS CHROMATIQUES / VARIACIONES CROMÁTICAS / ВАРИАНТЫ ОТТЕНКА



Significativa variazione di aspetto superficiale, grafica e colore da piastrella a piastrella e all'interno della stessa piastrella. Si consiglia di visionare la gamma cromatica prima della selezione del materiale / Significant variation in texture, pattern and colour from tile to tile within the same production run. The colour range should be viewed before selecting the material / Bedeutende Variation in Aussehen, Struktur und Farbe von Fliese zu Fliese und in ein und derselben Fliese. Es wird empfohlen, das Farbsortiment vor der Auswahl des Materials zu prüfen / Variation significative au niveau de l'aspect, de la fantaisie et de la couleur entre les carreaux et au sein d'un même carreau. Il est recommandé de consulter la gamme des couleurs avant de sélectionner le matériel / Variación considerable en el aspecto superficial, los motivos y el color entre un azulejo y otro y dentro del propio azulejo. Es aconsejable visualizar la gama cromática antes de seleccionar el material / Значительные отличия вида поверхности, графики и цвета у разных плиток и на одной и той же плитке. Перед отбором материала рекомендуется посмотреть цветовую гамму

DESTINAZIONE D'USO / INTENDED USE / ANWENDUNGSBEREICH / CHAMP D'APPLICATION / USO PREVISTO / НАЗНАЧЕНИЕ

### H (Outdoor)

Materiali consigliati per sollecitazioni all'abrasione relativamente forti in ambienti anche non protetti da agenti graffianti / Materials recommended for relatively heavy abrasion levels, also in premises not protected against abrasive substances / Materials recommended for relatively heavy abrasion levels, also in premises not protected against abrasive substances / Empfohlen für starke Abriebbeanspruchungen in Bereichen auch ohne Kratzschutzbehandlung / Matériaux recommandés pour des locaux soumis à des fortes contraintes d'abrasion, même non protégés contre les agents abrasifs / Materiales recomendados para soportar esfuerzos de abrasión relativamente intensos incluso en espacios no protegidos frente a agentes abrasivos / Материалы рекомендованы для относительно сильного абразивного воздействия, в том числе в помещениях, не защищенных от царапающих элементов

PEZZI SPECIALI / TRIMS / SPEZIALTEILE / PIÈCES SPÉCIALES / PIEZAS ESPECIALES / СПЕЦИАЛЬНЫЕ ИЗДЕЛИЯ

### BT.B.C.

Battiscopa Becco Civetta ottenuto da taglio del fondo / Coved Edge Skirting Tile cut from plain tile / Sockelleiste, Halbrundstab, aus Grundfliese geschnitten / Plinthe bord rond découpée dans le fond / Rodapié canto romo conseguido mediante corte del fondo / Плинтус с закругленным краем, полученный из фоновой плитки

### E.Elle

Elemento ad Elle monolitico / One-piece L-Tile / Schenkelplatte, einteilig / Élément en L monolithique / Elemento en forma de "L" monolítico / Монолитный Г-образный элемент

CARATTERISTICHE / CHARACTERISTICS / EIGENSCHAFTEN / CARACTERISTIQUES / DATOS / ХАРАКТЕРИСТИКИ

	<b>R11</b>	<b>PENDULUM classe 3 ptv &gt; 36</b>	<b>D-COF &gt; 0,42</b>	<b>BCR μ &gt; 0,40</b>
	<b>B</b>			
	<b>≤ 175 mm<sup>2</sup></b>			

CERTIFICAZIONI / CERTIFICATIONS / ZERTIFIZIERUNGEN / CERTIFICACIONES / СЕРТИФИКАЦИИ



CONSIGLI DI POSA / INSTALLATION ADVICE / HINWEISE ZUR VERLEGUNG / CONSEILS DE POSE / SUGERENCIAS PARA LA COLOCACIÓN / РЕКОМЕНДАЦИИ ПО УКЛАДКЕ

Per le pavimentazioni esterne non protette, Ragno consiglia di creare una pendenza ≥ 1,5% sulla superficie calpestabile allo scopo di limitare il formarsi di ristagni d'acqua localizzati. Nel caso in cui questi ristagni permangano sulla superficie delle piastrelle nonostante una posa a regola d'arte, è necessario intervenire meccanicamente con l'utilizzo di scope o aspira-liquidi / For unprotected outdoor pavings, Ragno recommends the creation of a gradient of ≥ 1.5% on the finished surface, to prevent the formation of patches of standing water. In the event that standing water persists on the surface of the tiles in spite of correct installation, it must be removed mechanically with the aid of brooms or wet-and-dry vacuum cleaners / Zur Unterbindung von punktueller Stauwasserbildung bei Belägen in ungeschützten Außenbereichen, empfiehlt die Ragno die Ausbildung eines Gefälles ≥ 1,5% auf der Trittlfläche. Sollte trotz fachgerechter Verlegung Stauwasser auf der Fliesenoberfläche zurückbleiben, ist dessen mechanische Entfernung mit Hilfe eines Besens oder Nasssaugers erforderlich / Pour des sols extérieurs non protégés, Ragno conseille de créer une inclinaison ≥ 1,5 % sur la surface de piétinement en vue de limiter la stagnation localisée de l'eau. Si, malgré une pose dans les règles de l'art, cette stagnation devait persister à la surface des carreaux, une intervention mécanique, au moyen de balais et d'aspirateurs de liquides, est alors nécessaire / En el caso de pavimentaciones exteriores no protegidas, Ragno recomienda crear una pendiente ≥ 1,5% en la superficie transitable para limitar la formación de depósitos localizados de agua estancada. En caso de que estos depósitos de agua permanezcan en la superficie del azulejo, aun cuando la colocación se haya realizado correctamente, será necesario intervenir mecánicamente empleando un cepillo o un aspirador de líquidos / Для наружных незащищенных полов Ragno рекомендует создавать уклон ≥ 1,5% на пешеходной поверхности для снижения образования локальных застоев воды. В случае, если застои воды образуются на плитке несмотря на правильную укладку, необходимо прибегать к использованию механических средств, таких как щетки или же аппараты для сбора жидкостей

IMBALLI / PACKAGING / VERPACKUNGEN / EMBALLAGES / EMBALAJES / УПАКОВКИ

	scatole / box / karton / boîte / caja / короб			pallet / pallet / palette / palette / pallet / поддон			
		<b>M<sup>2</sup></b>	<b>KG</b>		<b>M<sup>2</sup></b>	<b>KG</b>	<b>± mm</b>
30x60	5	0,90	18,08	48	43,20	867,63	9,5
30x30	12	1,08	22,40	40	43,20	895,98	9,5
15x30	20	0,90	16,83	64	57,60	1077,24	9
15x15	40	0,90	15,25	64	57,60	976,27	9,5
7x60	BT.B.C.	15	9,00 ml	18,23	-	-	10
15x30x4	E.ELLE	6	0,27	3,92	-	-	-

# CONCRETE EFFECT



202	Maiora Concrete
210	Stratford
218	Ironstone
226	Re_Solution
232	Patina
240	Boom
246	Rewind
252	Concept
258	Studio
264	Epoca
270	Calce
274	Eden

CONCRETE EFFECT

# Maiora Concrete



R6SM Bianco Rettificato 120x120 - 47<sup>1/4</sup> x 47<sup>1/4</sup>"



## Maiora Concrete

gres fine porcellanato colorato in massa - rettificato monocalibro / colorbody fine porcelain stoneware - rectified monocaliber / durchgefärbtes feinsteinzeug - rektifiziert, in einem werkmaß / grès cérame fin coloré dans la masse - rectifié monocalibre / gres porcelánico fino coloreado en toda la masa - rectificado monocalibre / гомогенный мелкозернистый керамогранит - ректифицированный монокалиберный

gruppo Bia UNI EN 14411\_G



nature/  
matt



120x278 cm  
47<sup>1/4</sup> x 109<sup>7/16</sup>"  
± 6 mm



120x240 cm  
47<sup>1/4</sup> x 94<sup>1/2</sup>"  
± 6 mm

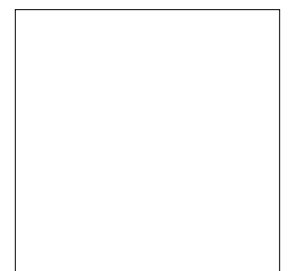

120x120 cm  
47<sup>1/4</sup> x 47<sup>1/4</sup>"  
± 6 mm

# Maiora Concrete

120x278 - 47<sup>1/4</sup>"x109<sup>7/16</sup>" 120x240 - 47<sup>1/4</sup>"x94<sup>1/2</sup>" 120x120 - 47<sup>1/4</sup>"x47<sup>1/4</sup>" 33,5x35 - 13<sup>3/16</sup>"x13<sup>3/4</sup>"

## Bianco



Concrete Effect variations 120x278

**R7GL** 120x278 Rett  
**R6SH** 120x240 Rett  
**R6SM** 120x120 Rett

## Grigio Chiaro



Concrete Effect variations 120x278

**R7GM** 120x278 Rett  
**R6SJ** 120x240 Rett  
**R6SN** 120x120 Rett



# Maiora Concrete

120x278 - 47<sup>1/4</sup> x 109<sup>7/16</sup> 120x240 - 47<sup>1/4</sup> x 94<sup>1/2</sup> 120x120 - 47<sup>1/4</sup> x 47<sup>1/4</sup> 33,5x35 - 13<sup>3/16</sup> x 13<sup>3/16</sup>

## Grigio Scuro



**R7GN** 120x278 Rett  
**R6SK** 120x240 Rett  
**R6SP** 120x120 Rett

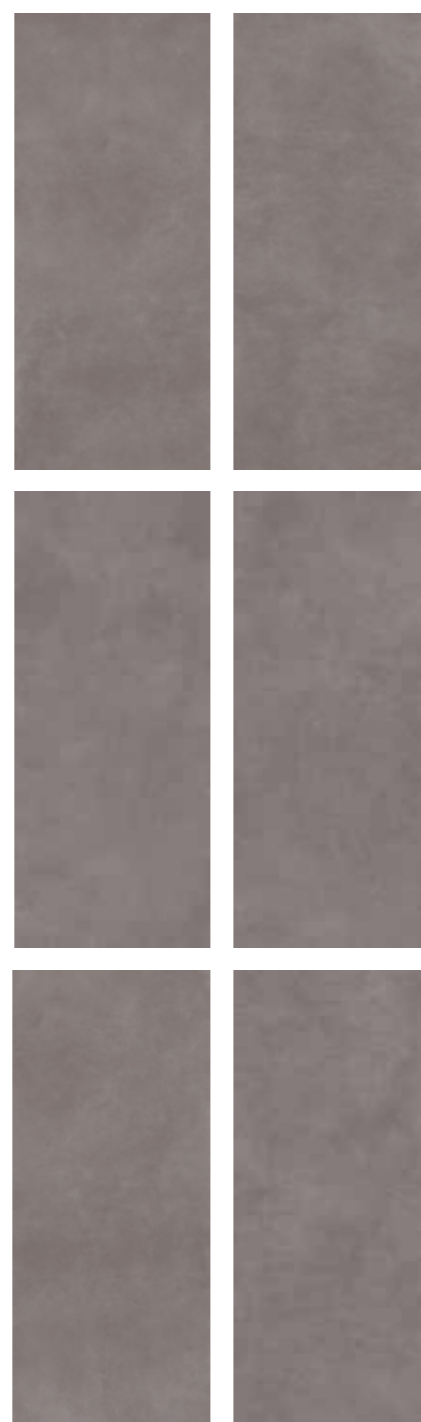

Concrete Effect variations 120x278

## Decors



**R817** 120x278 Botanical A Rett  
**R77X** 120x240 Botanical A Rett



**R81C** 120x278 Botanical B Rett  
**R77Y** 120x240 Botanical B Rett



**R81D** 120x278 Botanical C Rett  
**R77Z** 120x240 Botanical C Rett



**MATRIX** 33,5x35  
 Bianco / Grigio Chiaro / Grigio Scuro

# Maiora Concrete



R65N Grigio Chiaro Rettificato 120x120 - 47<sup>1/4</sup> x 47<sup>1/4</sup>

## TECH INFO

VARIAZIONI CROMATICHE / COLOUR VARIATIONS / FARBVARIATIONEN / VARIATIONEN CHROMATIQUES / VARIACIONES CROMÁTICAS / ВАРИАНТЫ ОТТЕНКА



Apprezzabili differenze nell'aspetto di superficie e grafica all'interno della stessa produzione / Clearly distinguishable differences in texture and pattern within the same production run / Auffällige Unterschiede in Aussehen und Struktur innerhalb der gleichen Produktionscharge / Différences visibles au niveau de l'aspect et de la fantaisie entre les carreaux du même lot de production / Diferencias visibles en el aspecto de la superficie y los motivos dentro de un mismo lote de producción / заметные отличия вида поверхности и графики в одной и той же партии

DESTINAZIONE D'USO / INTENDED USE / ANWENDUNGSBEREICH / CHAMP D'APPLICATION / USO PREVISTO / НАЗНАЧЕНИЕ

### H (Naturale/Matt)

Materiali consigliati per sollecitazioni all'abrasione relativamente forti in ambienti anche non protetti da agenti graffianti / Materials recommended for relatively heavy abrasion levels, also in premises not protected against abrasive substances / Materials recommended for relatively heavy abrasion levels, also in premises not protected against abrasive substances / Empfohlen für starke Abriebbeanspruchungen in Bereichen auch ohne Kratzschutzbehandlung / Matériaux recommandés pour des locaux soumis à des fortes contraintes d'abrasion, même non protégés contre les agents abrasifs / Materiales recomendados para soportar esfuerzos de abrasión relativamente intensos incluso en espacios no protegidos frente a agentes abrasivos / Материалы рекомендованы для относительно сильного абразивного воздействия, в том числе в помещениях, не защищенных от царапающих элементов

DECORI / DECORATIVE PIECES / DEKORE / DÉCORS / DECORACIONES / ДЕКОРЫ

### Botanical, Matrix

Produzione su richiesta / Production on request / Produktion auf Anfrage / Production sur demande / Producción bajo pedido / Изготовление по запросу

VARIAZIONI EFFETTO CEMENTO / CONCRETE EFFECT VARIATIONS / VARIATIONEN BETONOPTIK / VARIATIONEN EFFET BÉTON / VARIACIONES EFECTO CEMENTO / ВАРИАНТЫ ЭФФЕКТА ПОД ЦЕМЕНТ

Le immagini riportate rappresentano tutte le diverse grafiche del prodotto che vengono realizzate in successione sulla linea di produzione per ogni codice. Il codice prodotto è univoco: non è quindi possibile scegliere le grafiche e garantire la presenza di tutte le facce nella preparazione del materiale / The images shown illustrate the different product patterns manufactured in succession on the production line for each article. Every product code is unique: therefore, it is not possible to choose the patterns or guarantee that every tile surface will be included when the material is prepared / Les images reproduisent les différentes textures graphiques du produit, réalisées l'une à la suite de l'autre sur la ligne de production pour chaque code. Le code produit est univoque: il n'est donc pas possible de choisir les textures graphiques et de garantir la présence de toutes les variantes dans la préparation du matériau / Die Bilder zeigen die unterschiedlichen Materialzeichnungen des Produktes, die in der Produktionslinie für jeden Code nacheinander hergestellt werden. Es handelt sich um einen einheitlichen Produktcode: Aus diesem Grund ist es nicht möglich, die Materialzeichnungen auszuwählen und bei der Vorbereitung des Materials zu gewährleisten, dass alle Oberflächen vorhanden sind / Las imágenes presentadas muestran los diversos diseños gráficos del producto que se fabrican en serie en la línea de producción en referencia a cada código. El código del producto es unívoco: esto significa que no se pueden elegir los diseños gráficos y garantizar la presencia de todas las caras en la preparación del material / На изображениях приводятся все разнообразие графики изделий, которая выпускается на производственной линии в последовательности для каждого кода. Код изделия является единым, следовательно, нельзя выбирать графику и гарантировать наличие всех вариантов при подготовке материала

CARATTERISTICHE / CHARACTERISTICS / EIGENSCHAFTEN / CARACTERISTIQUES / DATOS / ХАРАКТЕРИСТИКИ

R10 Naturale/Matt	PENDULUM classe 1 Naturale/Matt p <sub>tv</sub> > 36 (Slider 96)	D-COF > 0,42	BCR μ > 0,40
≤ 175 mm <sup>3</sup>			

CERTIFICAZIONI / CERTIFICATIONS / ZERTIFIZIERUNGEN / CERTIFICACIONES / СЕРТИФИКАЦИИ



IMBALLI / PACKAGING / VERPACKUNGEN / EMBALLAGES / EMBALAJES / УПАКОВКИ

	scatole / box / karton / boîte / caja / короб			pallet / pallet / palette / palette / pallet / поддон			
	□	M²	KG	□	M²	KG	± mm
120x120	2	2,88	44,00	20	57,60	880,06	6

Imballaggio INCANTO & MAIORA > vedi Appendice / Packaging > see Appendix / Verpackungen > siehe Anhang / Emballages > voir Annexe / Embalajes > véase Apéndice / Упаковки > смотри Приложение

CONCRETE EFFECT

# Stratford



R8XC Grey Rettificato 120x120 - 47<sup>1/4</sup>"x47<sup>1/4</sup>" - R92A Struttura Crochet 3D White 21x18,2 - 8<sup>1/4</sup>"x7<sup>3/16</sup>"



## Stratford

gres fine porcellanato colorato in massa - rettificato monocalibro / colorbody fine porcelain stoneware - rectified monocaliber / durchgefärbtes feinsteinzeug - rektifiziert, in einem werkmaß / grès cérame fin coloré dans la masse - rectifié monocalibre / gres porcelánico fino coloreado en toda la masa - rectificado monocalibre / гомогенный мелкозернистый керамогранит - ректифицированный монокалиберный

21x18,2

gres porcellanato / porcelain stoneware / feinsteinzeug / grès cérame émaillé / gres porcelánico / керамогранит

gruppo Bia UNI EN 14411\_G

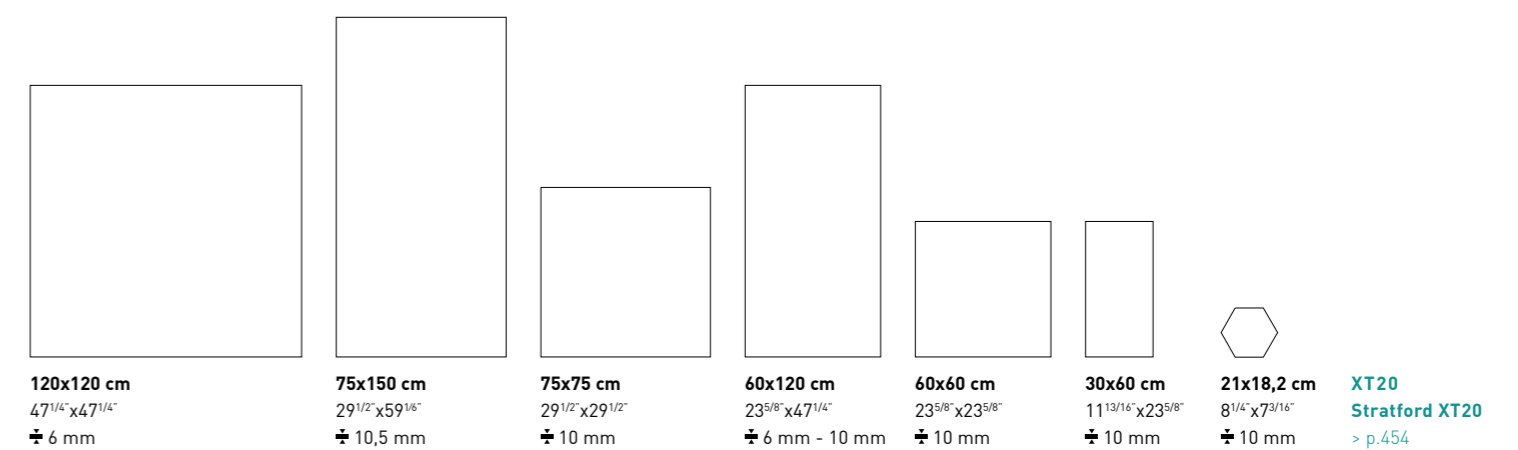

# Stratford

120x120 - 47<sup>1/4</sup>"x47<sup>1/4</sup>" 75x150 - 29<sup>1/2</sup>"x59<sup>1/8</sup>" 75x75 - 29<sup>1/2</sup>"x29<sup>1/2</sup>" 60x120 - 23<sup>5/8</sup>"x47<sup>1/4</sup>" 60x60 - 23<sup>5/8</sup>"x23<sup>5/8</sup>" 30x60 - 11<sup>3/16</sup>"x23<sup>5/8</sup>" 30x30 - 11<sup>3/16</sup>"x11<sup>3/16</sup>" 21x18,2 - 8<sup>1/4</sup>"x7<sup>3/16</sup>"

## Beige



- R8WY 120x120 Rett 6mm
- R8UW 75x150 Rett
- R8VD 75x75 Rett
- R8XF 60x120 Rett 6mm
- R8VK 60x120 Rett
- R8VR 60x120 Strutt Rett
- R8WH 60x60 Rett
- R8VX 60x60 Strutt Rett
- R8WP 30x60 Rett



R92Z 30x30 Mosaico



- R92D 7x60 BT.B.C.
- R92P 7x75 BT.B.C.



R96Z 15x60x4 E.ELLE

## Grey



- R8XC 120x120 Rett 6mm
- R8UZ 75x150 Rett
- R8VG 75x75 Rett
- R8XJ 60x120 Rett 6mm
- R8VN 60x120 Rett
- R8VU 60x120 Strutt Rett
- R8WL 60x60 Rett
- R8W8 60x60 Strutt Rett
- R8W5 30x60 Rett

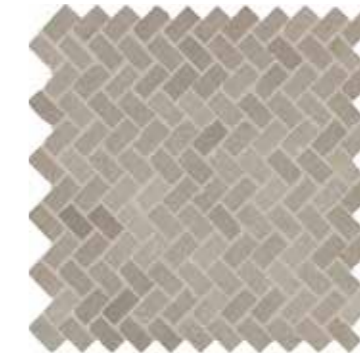

R93C 30x30 Mosaico



- R92G 7x60 BT.B.C.
- R92S 7x75 BT.B.C.



R97D 15x60x4 E.ELLE

## Clay



- R8WZ 120x120 Rett 6mm
- R8UX 75x150 Rett
- R8VE 75x75 Rett
- R8XG 60x120 Rett 6mm
- R8VL 60x120 Rett
- R8VS 60x120 Strutt Rett
- R8WJ 60x60 Rett
- R8VY 60x60 Strutt Rett
- R8WQ 30x60 Rett



R934 30x30 Mosaico



- R92F 7x60 BT.B.C.
- R92Q 7x75 BT.B.C.



R97A 15x60x4 E.ELLE

## Dark Grey



- R8XD 120x120 Rett 6mm
- R8VA 75x150 Rett
- R8VH 75x75 Rett
- R8XK 60x120 Rett 6mm
- R8VP 60x120 Rett
- R8VV 60x120 Strutt Rett
- R8WM 60x60 Rett
- R8WA 60x60 Strutt Rett
- R8WT 30x60 Rett

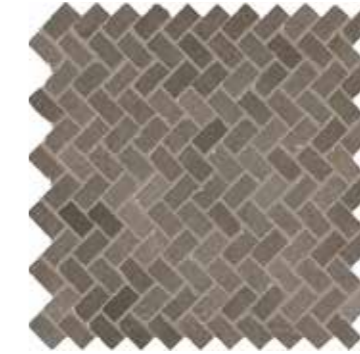

R93D 30x30 Mosaico



- R92H 7x60 BT.B.C.
- R92T 7x75 BT.B.C.



R97E 15x60x4 E.ELLE

## White

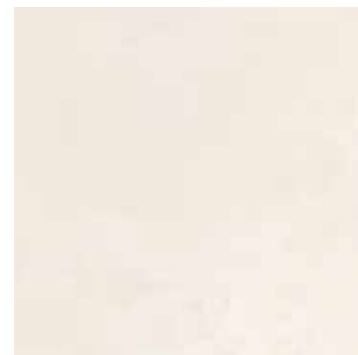

- R8XA 120x120 Rett 6mm
- R8UY 75x150 Rett
- R8VF 75x75 Rett
- R8XH 60x120 Rett 6mm
- R8VM 60x120 Rett
- R8VT 60x120 Strutt Rett
- R8WK 60x60 Rett
- R8VZ 60x60 Strutt Rett
- R8WR 30x60 Rett



R93A 30x30 Mosaico



- R92E 7x60 BT.B.C.
- R92R 7x75 BT.B.C.



R97C 15x60x4 E.ELLE

# Stratford

## Red



**R92V** 60x120 Rett  
**R8WD** 60x60 Rett

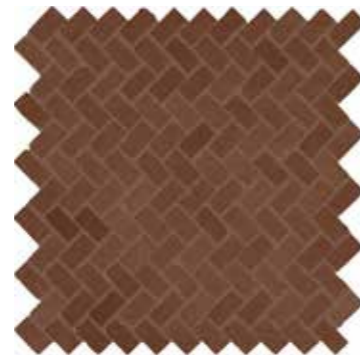

**R93F** 30x30 Mosaico



**R92K** 7x60 BT.B.C.

## Green



**R92X** 60x120 Rett  
**R8WE** 60x60 Rett



**R93H** 30x30 Mosaico



**R92M** 7x60 BT.B.C.

## Blue



**R92W** 60x120 Rett  
**R8WF** 60x60 Rett



**R93G** 30x30 Mosaico



**R92L** 7x60 BT.B.C.

120x120 - 47<sup>1/4</sup>"x47<sup>1/4</sup>" 75x150 - 29<sup>1/2</sup>"x59<sup>1/8</sup>" 75x75 - 29<sup>1/2</sup>"x29<sup>1/2</sup>" 60x120 - 23<sup>5/8</sup>"x47<sup>1/4</sup>" 60x60 - 23<sup>5/8</sup>"x23<sup>5/8</sup>" 30x60 - 11<sup>13/16</sup>"x23<sup>5/8</sup>" 30x30 - 11<sup>13/16</sup>"x11<sup>13/16</sup>" 21x18,2 - 8<sup>1/4</sup>"x7<sup>3/16</sup>"



**R8YC** 21x18,2 Esagona Beige



**R8YD** 21x18,2 Esagona Clay

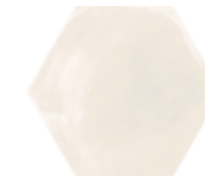

**R8YE** 21x18,2 Esagona White



**R8YF** 21x18,2 Esagona Grey



**R8YG** 21x18,2 Esagona Dark Grey



**R8YH** 21x18,2 Esagona Red



**R8YJ** 21x18,2 Esagona Green



**R8YK** 21x18,2 Esagona Blue

## Decors



**R8YM** 21x18,2 Decoro Tratto Beige



**R8YN** 21x18,2 Decoro Tratto Clay



**R8YP** 21x18,2 Decoro Tratto White



**R8YQ** 21x18,2 Decoro Tratto Grey



**R8YR** 21x18,2 Decoro Tratto Dark Grey



**R8YS** 21x18,2 Decoro Tratto Red



**R8YT** 21x18,2 Decoro Tratto Green



**R8YU** 21x18,2 Decoro Tratto Blue

# Stratford

120x120 - 47<sup>1/4</sup>" x 47<sup>1/4</sup>" 75x150 - 29<sup>1/2</sup>" x 59<sup>5/8</sup>" 75x75 - 29<sup>1/2</sup>" x 29<sup>1/2</sup>" 60x120 - 23<sup>5/8</sup>" x 47<sup>1/4</sup>" 60x60 - 23<sup>5/8</sup>" x 23<sup>5/8</sup>" 30x60 - 11<sup>13/16</sup>" x 23<sup>5/8</sup>" 30x30 - 11<sup>13/16</sup>" x 11<sup>13/16</sup>" 21x18,2 - 8<sup>1/4</sup>" x 7<sup>3/16</sup>"

## Decors



R8WV 60x120 Struttura Foglia 3D White



R8WW 60x120 Struttura Foglia 3D Grey



R92A 21x18,2 Struttura Crochet 3D White



R91Z 21x18,2 Struttura Crochet 3D Grey



R91T 120x120 Pannello Jap Clay  
[2pz x 60x120]

Abbinabile ai colori / Matching with colours / Mit den Grundfliesen kombinierbar / Peut s'associer aux carreaux de base de couleurs / Puede combinarse con los fondos / Сочетается с фоновой плиткой



Beige Clay Dark Grey Red



R91V 120x120 Pannello Prive White  
[2pz x 60x120]

Abbinabile ai colori / Matching with colours / Mit den Grundfliesen kombinierbar / Peut s'associer aux carreaux de base de couleurs / Puede combinarse con los fondos / Сочетается с фоновой плиткой



White Grey Green Blue

## TECH INFO

VARIAZIONI CROMATICHE / COLOUR VARIATIONS / FARBVARIATIONEN / VARIATIONS CHROMATIQUES / VARIACIONES CROMÁTICAS / ВАРИАНТЫ ОТТЕНКА



Apprezzabili differenze nell'aspetto di superficie e grafica all'interno della stessa produzione / Clearly distinguishable differences in texture and pattern within the same production run / Auffällige Unterschiede in Aussehen und Struktur innerhalb der gleichen Produktionscharge / Différences visibles au niveau de l'aspect et de la fantaisie entre les carreaux du même lot de production / Diferencias visibles en el aspecto de la superficie y los motivos dentro de un mismo lote de producción / заметные отличия вида поверхности и графики в одной и той же партии

DESTINAZIONE D'USO / INTENDED USE / ANWENDUNGSBEREICH / CHAMP D'APPLICATION / USO PREVISTO / НАЗНАЧЕНИЕ

vedi pag 689 / see page 689 / siehe Anhang 689 / voir page 689 / véase la pág. 689 / смотри на стр. 689)

H (Naturale/Matt, Strutturato)  
G (21x18,2; 60x120, 60x60: Blue e Green)

PEZZI SPECIALI / TRIMS / SPEZIALTEILE / PIÈCES SPÉCIALES / PIEZAS ESPECIALES / СПЕЦИАЛЬНЫЕ ИЗДЕЛИЯ

### BT.B.C.

Battiscopa Becco Civetta ottenuto da taglio del fondo / Coved Edge Skirting Tile cut from plain tile / Sockelleiste, Halbrundstab, aus Grundfliese geschnitten / Plinthe bord rond découpée dans le fond / Rodapié canto romo conseguido mediante corte del fondo / Плинтус с закругленным краем, полученный из фоновой плитки

### E.Elle

Elemento ad Elle tagliato ed assemblato / Two-piece L-Tile / Schenkelplatte, geschnitten und zusammengesetzt / Élément en L coupé et assemblé / Elemento en forma de "L" cortado y montado / Г-образный элемент, состоящий из двух частей

DECORI / DECORATIVE PIECES / DEKORE / DÉCORS / DECORACIONES / ДЕКОРЫ

### Mosaico

Mosaico assemblato su rete in fibra di vetro / Mosaic mesh - mounted on fibreglass / Auf Glasfasernetz geklebtes Mosaik / Mosaïque montée sur filet en fibre de verre / Mosaico enmallado sobre fibra de vidrio / Мозаика, собранная на сетке из стекловолокна

### Struttura Crochet 3D

5 diversi soggetti / 5 different motifs / 5 verschiedene Motive / 5 sujets différents / 5 temas diferentes / 5 различных рисунка

TECNOLOGIE / TECHNOLOGIES / TECHNOLOGIEN / TECHNOLOGIES / TECNOLOGÍAS / ТЕХНОЛОГИИ

### StepWise

Le piastrelle realizzate con questa nuova tecnologia sono caratterizzate da un'elevata resistenza allo scivolamento e da una superficie morbida al tatto e facile da pulire, data l'assenza di ruvidità superficiale / The tiles produced using this new technology have a high degree of slip resistance and a surface which is soft to the touch and easy to clean, since it has no superficial roughness / Les carreaux utilisant cette nouvelle technologie de production se distinguent par une très grande résistance à la glissance et par une surface douce au toucher et facile à nettoyer puisqu'elle ne présente aucune rugosité / Mit dieser neuen Technologie hergestellte Fliesen zeichnen sich durch eine hohe Rutschhemmung, eine weiche Haptik und eine einfache Reinigung aufgrund der fehlenden Oberflächenrauheit aus / Los azulejos fabricados aplicando esta nueva tecnología se caracterizan por su elevada resistencia al deslizamiento y por presentar una superficie suave al tacto y fácil de limpiar, dada la nula aspereza de su superficie / Произведенная по этой новой технологии плитка обладает высокой стойкостью к скольжению и мягкой на ощупь, легко очищающейся поверхностью, что обеспечивается отсутствием шероховатости на поверхности

Body Plus (Beige, Clay, White, Grey, Dark Grey, Red: 120X120, 60X120X6mm, 60X120X10mm, 75X150, 75X75, 60X60, 30X60, 30X30)

Prodotto ad alto contenuto tecnico caratterizzato dall'inclusione di scaglie a tutta massa con aspetto estremamente naturale / Bodyplus: High-tech product with through-body inclusion of chips giving an extremely natural appearance / Bodyplus: Produit à forte valeur technique caractérisé par l'incorporation incorporation dans la masse d'éclats de matières et par un aspect extrêmement naturel / Bodyplus: Hochtechnologisches Erzeugnis mit in den Scherben eingeschlossenen Körnungen von äußerst natürlichem Aussehen / Bodyplus: producto de alto contenido técnico caracterizado por la inclusión de esquirlas en toda la masa con un aspecto extremadamente natural / Bodyplus: Изделие с высоким технологическим содержанием, характеризующееся включением крошек по всей толщине, что придает ему очень естественный вид

### Sublime Sync (Struttura Foglia 3D)

Tecnologia digitale e struttura materica ad alta definizione / Digital technology and high-definition tactile structure / Technologie numérique et effet de matière en haute définition / High-Definition-Digitaldruck und-Materialtextur / Tecnología digital y estructura materica de alta definición / Цифровая технология и фактурная структура высокого разрешения

CARATTERISTICHE / CHARACTERISTICS / EIGENSCHAFTEN / CARACTERISTIQUES / DATOS / ХАРАКТЕРИСТИКИ

	R10 Naturale/Matt R11 Strutturato	PENDULUM classe 2 Naturale/Matt classe 3 Strutturato ptv > 36 p3 Naturale/Matt p4 Strutturato	D-COF > 0,42	BCR μ > 0,40
	B Naturale/Matt C Strutturato			
	≤ 175 mm²			

CERTIFICAZIONI / CERTIFICATIONS / ZERTIFIZIERUNGEN / CERTIFICACIONES / СЕРТИФИКАЦИИ



IMBALLI / PACKAGING / VERPACKUNGEN / EMBALLAJES / УПАКОВКИ

		scatole / box / karton / boîte / caja / коробк			pallet / pallet / palette / palette / pallet / поддон			
		□	M²	KG	□	M²	KG	± mm
120x120	Rettificato 6mm	2	2,88	43,00	20	57,60	860,09	6
120x120	Pannello Jap, Prive	1	1,44	34,00	10	14,40	340,00	10
75x150	Rettificato	2	2,25	55,00	21	47,25	1154,97	10,5
75x75	Rettificato	2	1,13	25,00	42	47,25	1050,00	10
60x120	Rettificato 6mm	3	2,16	32,00	15	32,40	480,00	6
60x120	Naturale/Matt, Strutturato	2	1,44	34,50	36	51,84	1241,97	10
60x120	Struttura Foglia 3D	2	1,44	34,50	36	51,84	1241,97	10
60x60	Rettificato	3	1,08	23,00	40	43,20	920,13	10
60x60	Strutturato	3	1,08	22,50	40	43,20	900,00	10
30x60	Rettificato	6	1,08	22,50	48	51,84	1080,00	10
30x30	Mosaico	4	0,36	5,49	60	21,60	480,00	10
21x18,2	Esagona, Decoro Tratto	15	0,43	7,50	100	42,99	749,87	10
21x18,2	Struttura Crochet 3D	15	0,43	7,50	100	42,99	749,87	10
15x60x4	E.ELLE	4	0,36	7,50	-	-	-	-
7x60	BT.B.C.	14	8,40 ml	20,00	-	-	-	10
7x75	BT.B.C.	14	10,50 ml	20,00	-	-	-	10

CONCRETE EFFECT

## Ironstone

R8DZ Bianco Rettificato 75x150 - 29<sup>1/2</sup>"x59<sup>1/8</sup>"







## Ironstone

gres fine porcellanato colorato in massa - rettificato monocalibro / colorbody fine porcelain stoneware - rectified monocaliber / durchgefärbtes feinsteinzeug - rektifiziert, in einem werkmaß / grès cérame fin coloré dans la masse - rectifié monocalibre / gres porcelánico fino coloreado en toda la masa - rectificado monocalibre / гомогенный мелкозернистый керамогранит - ректифицированный монокалиберный

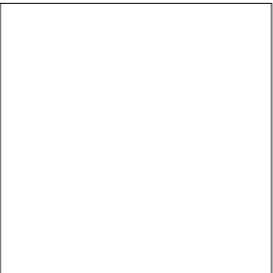
gruppo Bia UNI EN 14411\_G

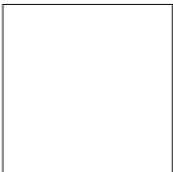

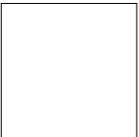
naturale/  
matt

					
<b>120x120 cm</b> 47 <sup>1/4</sup> "x47 <sup>1/4</sup> " ± 6 mm	<b>75x150 cm</b> 29 <sup>1/2</sup> "x59 <sup>1/8</sup> " ± 9,5 mm	<b>75x75 cm</b> 29 <sup>1/2</sup> "x29 <sup>1/2</sup> " ± 9,5 mm	<b>60x120 cm</b> 23 <sup>5/8</sup> "x47 <sup>1/4</sup> " ± 6 mm	<b>60x60 cm</b> 23 <sup>5/8</sup> "x23 <sup>5/8</sup> " ± 9,5 mm	<b>30x60 cm</b> 11 <sup>13/16</sup> "x23 <sup>5/8</sup> " ± 9,5 mm

# Ironstone

120x120 - 47<sup>1/4</sup>"x47<sup>3/4</sup>" 75x150 - 29<sup>1/2</sup>"x59<sup>1/8</sup>" 75x75 - 29<sup>1/2</sup>"x29<sup>1/2</sup>" 60x120 - 23<sup>5/8</sup>"x47<sup>3/4</sup>" 60x60 - 23<sup>5/8</sup>"x23<sup>5/8</sup>" 30x60 - 11<sup>13/16</sup>"x23<sup>5/8</sup>" 37,5x37,5 - 14<sup>3/4</sup>"x14<sup>3/4</sup>" 30x30 - 11<sup>13/16</sup>"x11<sup>13/16</sup>"

## Bianco



**R8RL** 120x120 Rett  
**R8DZ** 75x150 Rett  
**R8E9** 75x75 Rett  
**R8RR** 60x120 Rett  
**R8ED** 60x60 Rett  
**R8EG** 30x60 Rett



**R8EK** 30x30 Mosaico



**R8EN** 7x60 BT.B.C.  
**R8ER** 7x75 BT.B.C.

## Ghisa



**R8RJ** 120x120 Rett  
**R7F8** 75x150 Rett  
**R7FC** 75x75 Rett  
**R8RP** 60x120 Rett  
**R7FF** 60x60 Rett  
**R7FJ** 30x60 Rett



**R7XG** 30x30 Mosaico



**R7QC** 7x60 BT.B.C.  
**R7PY** 7x75 BT.B.C.

## Argento



**R8RK** 120x120 Rett  
**R7F9** 75x150 Rett  
**R7FD** 75x75 Rett  
**R8RQ** 60x120 Rett  
**R7FG** 60x60 Rett  
**R7FK** 30x60 Rett

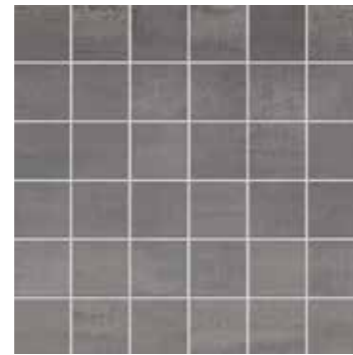

**R7XE** 30x30 Mosaico



**R7QA** 7x60 BT.B.C.  
**R7PX** 7x75 BT.B.C.

## Decors



**R8EX** 75x75 Tribale Bianco



**R7WW** 75x75 Tribale Argento

## Corten



**R8RM** 120x120 Rett  
**R8E3** 75x150 Rett  
**R8EA** 75x75 Rett  
**R8RS** 60x120 Rett  
**R8EE** 60x60 Rett  
**R8EH** 30x60 Rett



**R8EL** 30x30 Mosaico



**R8EP** 7x60 BT.B.C.  
**R8ES** 7x75 BT.B.C.



**R8EY** 75x75 Tribale Corten



**R7WY** 75x75 Tribale Ghisa



# Ironstone

## Decors



**R8EU** 75x75 Retrò Bianco



**R7XA** 75x75 Retrò Argento



**R8EV** 75x75 Retrò Corten



**R7XC** 75x75 Retrò Ghisa



**R8EV** 75x75 Retrò Corten



**R7XC** 75x75 Retrò Ghisa

120x120 - 47<sup>1/8</sup>"x47<sup>1/8</sup>" 75x150 - 29<sup>1/2</sup>"x59<sup>1/8</sup>" 75x75 - 29<sup>1/2</sup>"x29<sup>1/2</sup>" 60x120 - 23<sup>5/8</sup>"x47<sup>1/8</sup>" 60x60 - 23<sup>5/8</sup>"x23<sup>5/8</sup>" 30x60 - 11<sup>13/16</sup>"x23<sup>5/8</sup>" 37,5x37,5 - 14<sup>3/4</sup>"x14<sup>3/4</sup>" 30x30 - 11<sup>13/16</sup>"x11<sup>13/16</sup>"



**R8FA** 37,5x37,5 Mosaico Flora Bianco



**R7RM** 37,5x37,5 Mosaico Flora Argento



**R7RL** 37,5x37,5 Mosaico Flora Ghisa

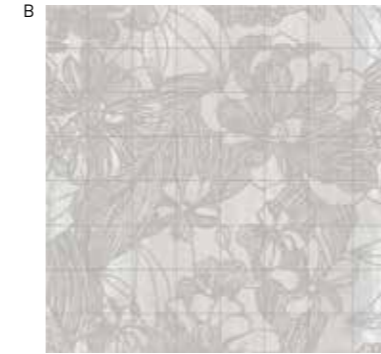

**R8FA** 37,5x37,5 Mosaico Flora Bianco



**R7RM** 37,5x37,5 Mosaico Flora Argento



**R7RL** 37,5x37,5 Mosaico Flora Ghisa

# Ironstone



R7FD Argento Rettificato 75x75 - 29<sup>1/2</sup> x 29<sup>1/2</sup> - R7XE Mosaico Argento 30x30 - 11<sup>13/16</sup> x 11<sup>13/16</sup> - R7RM Mosaico Flora Argento 37,5x37,5 - 14<sup>3/4</sup> x 14<sup>3/4</sup>

## TECH INFO

VARIAZIONI CROMATICHE / COLOUR VARIATIONS / FARBVARIATIONEN / VARIATIONS CHROMATIQUES / VARIACIONES CROMÁTICAS / ВАРИАНТЫ ОТТЕНКА



Apprezzabili differenze nell'aspetto di superficie e grafica all'interno della stessa produzione / Clearly distinguishable differences in texture and pattern within the same production run / Auffällige Unterschiede in Aussehen und Struktur innerhalb der gleichen Produktionscharge / Différences visibles au niveau de l'aspect et de la fantaisie entre les carreaux du même lot de production / Diferencias visibles en el aspecto de la superficie y los motivos dentro de un mismo lote de producción / заметные отличия вида поверхности и графики в одной и той же партии

DESTINAZIONE D'USO / INTENDED USE / ANWENDUNGSBEREICH / CHAMP D'APPLICATION / USO PREVISTO / НАЗНАЧЕНИЕ

### G (Naturale/Matt)

Materiali consigliati per locali sottoposti a sollecitazioni all'abrasione medio pesanti come: case individuali, commerciale leggero / Materials recommended for premises with medium-heavy abrasion levels, such as: detached homes, light-traffic commercial premises / Empfohlen für Räume mit mittelschwerer Abriebbeanspruchung wie: Einfamilienhäuser, leicht beanspruchte Gewerbebereiche / Matériaux recommandés pour des locaux soumis à des contraintes d'abrasion moyennes et fortes comme : maisons particulières, espaces commerciaux soumis à un trafic léger, etc / Materiales recomendados para locales sometidos a esfuerzos de abrasión medio-pesados, como casas unifamiliares y locales comerciales de tráfico ligero / Материалы рекомендованы для использования в частных домах и коммерческих помещениях, подверженных средне-сильному абразивному воздействию

DECORI / DECORATIVE PIECES / DEKORE / DÉCORS / DECORACIONES / ДЕКОРЫ

### Mosaico

Mosaico assemblato con tratto plastico / Spot-bonded mosaic / Punktverklebtes Mosaik / Mosaïque montée avec trait de colle / Mosaico colocado aplicando cola plástica / Мозаика с сегментами, выполненными из пластмассы - Мозаика, собранная на клеевой точке

### Decoro Retrò

2 diversi soggetti / 2 different motifs / 2 verschiedene Motive / 2 sujets différents / 2 temas diferentes / 2 различных рисунка

CARATTERISTICHE / CHARACTERISTICS / EIGENSCHAFTEN / CARACTERISTIQUES / DATOS / ХАРАКТЕРИСТИКИ

	R9 Naturale/Matt	PENDULUM classe 1	D-COF > 0,42	BCR $\mu > 0,40$
	$\leq 175 \text{ mm}^2$			

CERTIFICAZIONI / CERTIFICATIONS / ZERTIFIZIERUNGEN / CERTIFICATIONS / CERTIFICACIONES / СЕРТИФИКАЦИИ



IMBALLI / PACKAGING / VERPACKUNGEN / EMBALLAGES / EMBALAJES / УПАКОВКИ

		scatole / box / karton / boîte / caja / короб			pallet / pallet / palette / palette / pallet / поддон			
		□	M²	KG	□	M²	KG	±mm
120x120 6mm	Rettificato	2	2,88	46,00	20	57,60	919,98	6
60x120 6mm	Rettificato	3	2,16	31,56	15	32,40	473,41	6
75x150	Rettificato	2	2,25	51,81	21	47,25	1088,00	9,5
75x75	Rettificato	2	1,13	23,81	42	47,25	1000,00	9,5
60x60	Rettificato	3	1,08	22,50	40	43,20	900,00	9,5
30x60	Rettificato	6	1,08	23,04	48	51,84	1105,80	9,5
75x75	Decoro "su richiesta"	2	1,13	26,00	-	-	-	9,5
37,5x37,5	Mosaico Flora	4	0,56	14,00	-	-	-	9,5
30x30	Mosaico	4	0,36	8,00	-	-	-	9,5
7x75	BT.B.C.	14	10,50 ml	18,87	-	-	-	9,5
7x60	BT.B.C.	14	8,40 ml	18,18	-	-	-	9,5

CONCRETE EFFECT

# Re\_Solution



R61D Greige Rettificato 75x150 - 29<sup>1/2</sup> x 59<sup>1/8</sup>"



## Re\_Solution

gres fine porcellanato colorato in massa - rettificato monocalibro / colorbody fine porcelain stoneware - rectified monocaliber / durchgefärbtes feinsteinzeug - rektifiziert, in einem werkmaß / grès cérame fin coloré dans la masse - rectifié monocalibre / gres porcelánico fino coloreado en toda la masa - rectificado monocalibre / гомогенный мелкозернистый керамогранит - ректифицированный монокалиберный

gruppo Bla UNI EN 14411\_G



naturale/  
matt

glossy

outdoor

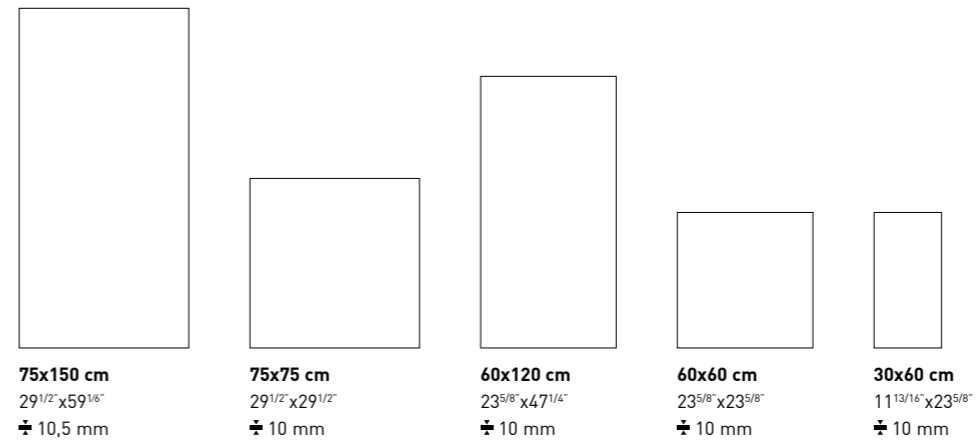

# Re\_Solution

75x150 - 29<sup>1/2</sup>"x59<sup>1/4</sup>" 75x75 - 29<sup>1/2</sup>"x29<sup>1/2</sup>" 60x120 - 23<sup>5/8</sup>"x47<sup>1/4</sup>" 60x60 - 23<sup>5/8</sup>"x23<sup>5/8</sup>" 30x60 - 11<sup>13/16</sup>"x23<sup>5/8</sup>" 37,5x37,5 - 14<sup>3/4</sup>"x14<sup>3/4</sup>" 30x30 - 11<sup>13/16</sup>"x11<sup>13/16</sup>"

## Blanc



**R6TY** 7x60 BT.B.C.  
**R6UQ** 7x75 BT.B.C.



**R6WX** 15x75x4 E.ELLE

**R619** 75x150 Rett  
**R61H** 75x75 Rett  
**R61P** 75x75 Strutt Rett  
**R6HL** 75x75 Brill Rett  
**R6YA** 60x120 Rett  
**R61V** 60x60 Rett  
**R6HZ** 60x60 Brill Rett  
**R621** 30x60 Rett  
**R6YK** 30x60 Brill Rett

**R6RD** 30x30 Mosaico

## Pencil

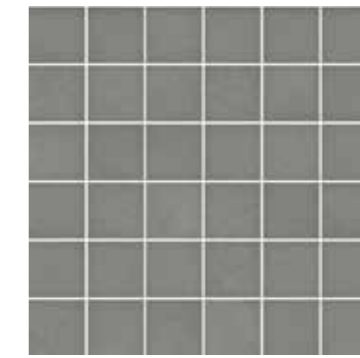

**R6UF** 7x60 BT.B.C.  
**R6UW** 7x75 BT.B.C.



**R6XE** 15x75x4 E.ELLE

**R61E** 75x150 Rett  
**R61L** 75x75 Rett  
**R61S** 75x75 Strutt Rett  
**R6HS** 75x75 Brill Rett  
**R6YF** 60x120 Rett  
**R61Y** 60x60 Rett  
**R6J5** 60x60 Brill Rett  
**R624** 30x60 Rett  
**R6YN** 30x60 Brill Rett

**R6RG** 30x30 Mosaico

## Linen



**R6UA** 7x60 BT.B.C.  
**R6US** 7x75 BT.B.C.



**R6WZ** 15x75x4 E.ELLE

**R61C** 75x150 Rett  
**R61J** 75x75 Rett  
**R61Q** 75x75 Strutt Rett  
**R6HN** 75x75 Brill Rett  
**R6YC** 60x120 Rett  
**R61W** 60x60 Rett  
**R6J1** 60x60 Brill Rett  
**R622** 30x60 Rett  
**R6YL** 30x60 Brill Rett

**R6RE** 30x30 Mosaico

## Smoke

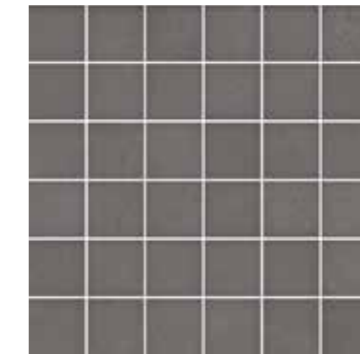

**R6UH** 7x60 BT.B.C.  
**R6UY** 7x75 BT.B.C.

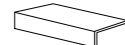

**R6XG** 15x75x4 E.ELLE

**R61F** 75x150 Rett  
**R61M** 75x75 Rett  
**R61T** 75x75 Strutt Rett  
**R6HU** 75x75 Brill Rett  
**R6YG** 60x120 Rett  
**R61Z** 60x60 Rett  
**R6J8** 60x60 Brill Rett  
**R625** 30x60 Rett  
**R6YP** 30x60 Brill Rett

**R6RH** 30x30 Mosaico

## Greige



**R6UD** 7x60 BT.B.C.  
**R6UU** 7x75 BT.B.C.

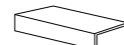

**R6XC** 15x75x4 E.ELLE

**R61D** 75x150 Rett  
**R61K** 75x75 Rett  
**R61R** 75x75 Strutt Rett  
**R6HQ** 75x75 Brill Rett  
**R6YD** 60x120 Rett  
**R61X** 60x60 Rett  
**R6J3** 60x60 Brill Rett  
**R623** 30x60 Rett  
**R6YM** 30x60 Brill Rett

**R6RF** 30x30 Mosaico

## Urban

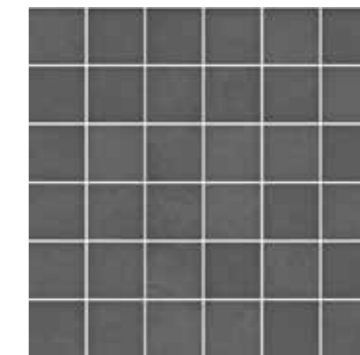

**R6UL** 7x60 BT.B.C.  
**R6VC** 7x75 BT.B.C.

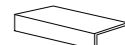

**R6XJ** 15x75x4 E.ELLE

**R61G** 75x150 Rett  
**R61N** 75x75 Rett  
**R61U** 75x75 Strutt Rett  
**R6HW** 75x75 Brill Rett  
**R6YH** 60x120 Rett  
**R620** 60x60 Rett  
**R6JA** 60x60 Brill Rett  
**R626** 30x60 Rett  
**R6YQ** 30x60 Brill Rett

**R6RJ** 30x30 Mosaico

# Re\_Solution

75x150 - 29<sup>1/2</sup>"x59<sup>1/16</sup>" 75x75 - 29<sup>1/2</sup>"x29<sup>1/2</sup>" 60x120 - 23<sup>5/8</sup>"x47<sup>1/16</sup>" 60x60 - 23<sup>5/8</sup>"x23<sup>5/8</sup>" 30x60 - 11<sup>13/16</sup>"x23<sup>5/8</sup>" 37,5x37,5 - 14<sup>3/4</sup>"x14<sup>3/4</sup>" 30x30 - 11<sup>13/16</sup>"x11<sup>13/16</sup>"

## Decors



**R6QY** 75x75 Decoro Trame Blanc

Abbinabile ai colori / Matching with colours / Mit den Grundfliesen kombinierbar / Peut s'associer aux carreaux de base de couleurs / Puede combinarse con los fondos / Сочетается с фоновой плиткой



**Blanc**

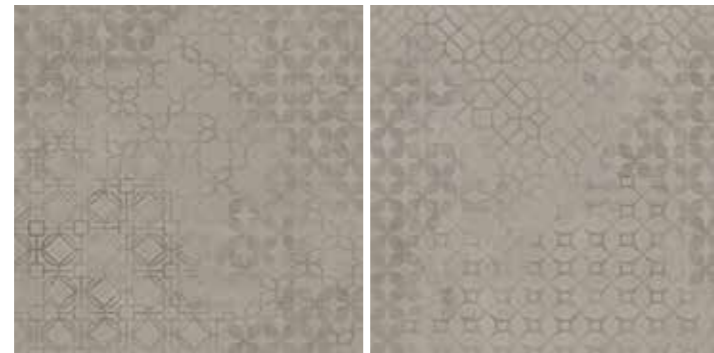

**R6QX** 75x75 Decoro Trame Linen

Abbinabile ai colori / Matching with colours / Mit den Grundfliesen kombinierbar / Peut s'associer aux carreaux de base de couleurs / Puede combinarse con los fondos / Сочетается с фоновой плиткой



**Linen Greige**



**R6QZ** 75x75 Decoro Trame Pencil

Abbinabile ai colori / Matching with colours / Mit den Grundfliesen kombinierbar / Peut s'associer aux carreaux de base de couleurs / Puede combinarse con los fondos / Сочетается с фоновой плиткой



**Pencil Smoke**



**R6TK** 37,5x37,5 Mosaico Blend Linen

Abbinabile ai colori / Matching with colours / Mit den Grundfliesen kombinierbar / Peut s'associer aux carreaux de base de couleurs / Puede combinarse con los fondos / Сочетается с фоновой плиткой



**Blanc Linen Greige**



**R6RA** 37,5x37,5 Mosaico Blend Pencil

Abbinabile ai colori / Matching with colours / Mit den Grundfliesen kombinierbar / Peut s'associer aux carreaux de base de couleurs / Puede combinarse con los fondos / Сочетается с фоновой плиткой



**Pencil Smoke Urban**

## TECH INFO

VARIAZIONI CROMATICHE / COLOUR VARIATIONS / FARBVARIATIONEN / VARIATIONS CHROMATIQUES / VARIACIONES CROMÁTICAS / ВАРИАНТЫ ОТТЕНКА



Apprezzabili differenze nell'aspetto di superficie e grafica all'interno della stessa produzione / Clearly distinguishable differences in texture and pattern within the same production run / Auffällige Unterschiede in Aussehen und Struktur innerhalb der gleichen Produktionscharge / Différences visibles au niveau de l'aspect et de la fantaisie entre les carreaux du même lot de production / Diferencias visibles en el aspecto de la superficie y los motivos dentro de un mismo lote de producción / заметные отличия вида поверхности и графики в одной и той же партии

DESTINAZIONE D'USO / INTENDED USE / ANWENDUNGSBEREICH / CHAMP D'APPLICATION / USO PREVISTO / НАЗНАЧЕНИЕ

### G (Brill)

Materiali consigliati per locali sottoposti a sollecitazioni all'abrasione medio pesanti come: case individuali, commerciale leggero / Materials recommended for premises with medium-heavy abrasion levels, such as: detached homes, light-traffic commercial premises / Empfohlen für Räume mit mittelschwerer Abriebbeanspruchung wie: Einfamilienhäuser, leicht beanspruchte Gewerbebereiche / Matériaux recommandés pour des locaux soumis à des contraintes d'abrasion moyennes et fortes comme : maisons particulières, espaces commerciaux soumis à un trafic léger, etc / Materiales recomendados para locales sometidos a esfuerzos de abrasión medio-pesados, como casas unifamiliares y locales comerciales de tráfico ligero / Materiales recomendados para uso en viviendas unifamiliares y locales comerciales de tráfico ligero / Материалы рекомендуются для использования в частных домах и коммерческих помещениях, подверженных средне-сильному абразивному воздействию

### H (Naturale/Matt, Strutturato)

Materiali consigliati per sollecitazioni all'abrasione relativamente forti in ambienti anche non protetti da agenti graffianti / Materials recommended for relatively heavy abrasion levels, also in premises not protected against abrasive substances / Materials recommended for relatively heavy abrasion levels, also in premises not protected against abrasive substances / Empfohlen für starke Abriebbeanspruchungen in Bereichen auch ohne Kratzschutzbehandlung / Matériaux recommandés pour des locaux soumis à des fortes contraintes d'abrasion, même non protégés contre les agents abrasifs / Materiales recomendados para soportar esfuerzos de abrasión relativamente intensos incluso en espacios no protegidos frente a agentes abrasivos / Материалы рекомендуются для относительно сильного абразивного воздействия, в том числе в помещениях, не защищенных от царапающих элементов

DECORI / DECORATIVE PIECES / DEKORE / DÉCORS / DECORACIONES / ДЕКОРЫ

### Decoro Trame

Il decoro Trame non ha un verso di posa. Eventuali irregolarità del disegno dovute alla posa casuale del prodotto non sono da considerarsi un difetto ma una caratteristica distintiva del decoro Trame / Trame decor can be laid in any direction. Any design irregularities due to the random installation of the product are not to be regarded as defects but rather distinctive features of the Trame decor. / Das Dekor Trame hat keine Verlegerichtung. Unregelmäßigkeiten des Patterns, die durch die Verlegung mit Zufallsbild entstehen, sind nicht als Defekt, sondern als besonderes Merkmal des Dekors Trame anzusehen / Le décor Trame n'a pas de sens de pose. Les éventuelles irrégularités du dessin dues à la pose aléatoire du produit ne doivent pas être considérées comme un défaut mais comme une caractéristique du décor Trame / La decoración Trame no tiene un sentido de colocación preciso. Cualquier irregularidad en el dibujo que se deba a la colocación aleatoria del producto no deberá considerarse como un defecto sino como una característica distintiva de la decoración Trame / Декор Trame не имеет направления укладки. Возможная неравномерность рисунка, вызванная произвольной укладкой изделий, должна рассматриваться не как дефект, а как отличительная характеристика декора Trame

### Mosaico

Mosaico assemblato con tratto plastico / Spot-bonded mosaic / Punktverklebtes Mosaik / Mosaïque montée avec trait de colle / Mosaico colocado aplicando cola plástica / Мозаика с сегментами, выполненными из пластмассы - Мозаика, собранная на клеевой точке

PEZZI SPECIALI / TRIMS / SPEZIALTEILE / PIÈCES SPÉCIALES / PIEZAS ESPECIALES / СПЕЦИАЛЬНЫЕ ИЗДЕЛИЯ

### BT.B.C.

Battiscopa Becco Civetta ottenuto da taglio del fondo / Coved Edge Skirting Tile cut from plain tile / Sockelleiste, Halbrundstab, aus Grundfliese geschnitten / Plinthe bord rond découpée dans le fond / Rodapié canto romo conseguido mediante corte del fondo / Плинтус с закругленным краем, полученный из фоновой плитки

### E.Elle

Elemento ad Elle tagliato ed assemblato / Two-piece L-Tile / Schenkelplatte, geschnitten und zusammengesetzt / Élément en L coupé et assemblé / Elemento en forma de "L" cortado y montado / Г-образный элемент, состоящий из двух частей

CARATTERISTICHE / CHARACTERISTICS / EIGENSCHAFTEN / CARACTERISTIQUES / DATOS / ХАРАКТЕРИСТИКИ

	<b>R10</b> Naturale/Matt <b>R11</b> Strutturato	<b>PENDULUM</b> <b>classe 1</b> Naturale/Matt <b>classe 3</b> Strutturato <b>ptv &gt; 36</b> Strutturato	<b>D-COF</b> <b>&gt; 0,42</b> Nat/Matt, Strutt	<b>BCR</b> <b>μ &gt; 0,40</b> Nat/Matt, Strutt
	<b>A</b> Naturale/Matt <b>C</b> Strutturato			
	<b>≤ 175 mm<sup>2</sup></b>			

CERTIFICAZIONI / CERTIFICATIONS / ZERTIFIZIERUNGEN / CERTIFICACIONES / СЕРТИФИКАЦИИ



IMBALLI / PACKAGING / VERPACKUNGEN / EMBALLAGES / EMBALAJES / УПАКОВКИ

		scatole / box / karton / boîte / caja / короб			pallet / pallet / palette / palette / pallet / поддон			
		□	M <sup>2</sup>	KG	□	M <sup>2</sup>	KG	±mm
75x150	Rettificato	2	2,25	55,99	21	47,25	1175,69	10,5
60x120	Rettificato	2	1,44	32,60	36	51,84	1173,65	10
75x75	Rettificato	2	1,13	26,45	42	47,25	1111,02	10
60x60	Rettificato	3	1,08	26,22	40	43,20	1048,82	10
30x60	Rettificato	6	1,08	24,20	48	51,84	1137,59	10
75x75	Decoro Trame	2	1,13	25,48	42	47,25	1070,30	10
37,5x37,5	Mosaico Blend	4	0,56	14,38	60	33,75	863,00	10
30x30	Mosaico	4	0,36	8,50	80	28,80	660,00	10
15x75x4	E.ELLE	2	0,23	10,00	-	-	-	-
7x60	BT.B.C.	15	9,00 ml	18,18	-	-	-	10
7x75	BT.B.C.	13	9,75 ml	18,00	-	-	-	10

CONCRETE EFFECT

# Patina



R850 Cognac Rettificato 75x150 - 29<sup>1/2</sup> x 59<sup>1/8</sup>"







## Patina

gres fine porcellanato colorato in massa - rettificato monocalibro / colorbody fine porcelain stoneware - rectified monocaliber / durchgefärbtes feinsteinzeug - rektifiziert, in einem werkmaß / grès cérame fin coloré dans la masse - rectifié monocalibre / gres porcelánico fino coloreado en toda la masa - rectificado monocalibre / гомогенный мелкозернистый керамогранит - ректифицированный монокалиберный

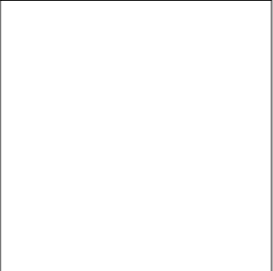
gruppo Bla UNI EN 14411\_G

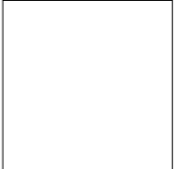
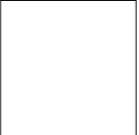

				
<b>120x120 cm</b> 47 <sup>1/4</sup> x 47 <sup>1/4</sup> " ± 10,5 mm	<b>75x150 cm</b> 29 <sup>1/2</sup> x 59 <sup>1/8</sup> " ± 9,5 mm	<b>75x75 cm</b> 29 <sup>1/2</sup> x 29 <sup>1/2</sup> " ± 9,5 mm	<b>60x60 cm</b> 23 <sup>5/8</sup> x 23 <sup>5/8</sup> " ± 10 mm	<b>30x60 cm</b> 11 <sup>13/16</sup> x 23 <sup>5/8</sup> " ± 10 mm

XT20  
Patina XT20  
> p.460

# Patina

120x120 - 47<sup>1/4</sup> x 47<sup>1/4</sup> 75x150 - 29<sup>1/2</sup> x 59<sup>1/8</sup> 75x75 - 29<sup>1/2</sup> x 29<sup>1/2</sup> 60x60 - 23<sup>5/8</sup> x 23<sup>5/8</sup> 30x60 - 11<sup>13/16</sup> x 23<sup>5/8</sup> 37,5x37,5 - 14<sup>3/4</sup> x 14<sup>3/4</sup> 30x30 - 11<sup>13/16</sup> x 11<sup>13/16</sup>

## Cera



**R16K** 120x120 Rett  
**R85N** 75x150 Rett  
**R85S** 75x75 Rett  
**RGK0** 75x75 Smoth Rett  
**R85Y** 60x60 Rett  
**R86K** 30x60 Rett



**R71W** 7x60 BT.B.C.  
**R71P** 7x75 BT.B.C.

## Asfalto



**R16R** 120x120 Rett  
**R85R** 75x150 Rett  
**R85V** 75x75 Rett  
**RGK3** 75x75 Smoth Rett  
**R86A** 60x60 Rett  
**R86N** 30x60 Rett



**R71Z** 7x60 BT.B.C.  
**R71T** 7x75 BT.B.C.

## Crema



**R16P** 120x120 Rett  
**R85P** 75x150 Rett  
**R85T** 75x75 Rett  
**RGK1** 75x75 Smoth Rett  
**R85Z** 60x60 Rett  
**R86L** 30x60 Rett



**R71X** 7x60 BT.B.C.  
**R71R** 7x75 BT.B.C.

## Petrolio



**R16S** 120x120 Rett  
**R86H** 75x150 Rett  
**R85W** 75x75 Rett  
**RGK4** 75x75 Smoth Rett  
**R86C** 60x60 Rett  
**R86P** 30x60 Rett



**R721** 7x60 BT.B.C.  
**R71U** 7x75 BT.B.C.

## Cognac



**R16Q** 120x120 Rett  
**R85Q** 75x150 Rett  
**R85U** 75x75 Rett  
**RGK2** 75x75 Smoth Rett  
**R861** 60x60 Rett  
**R86M** 30x60 Rett



**R71Y** 7x60 BT.B.C.  
**R71S** 7x75 BT.B.C.

## Marsala



**R86J** 75x150 Rett  
**R85X** 75x75 Rett  
**RGK5** 75x75 Smoth Rett  
**R86D** 60x60 Rett  
**R86Q** 30x60 Rett



**R722** 7x60 BT.B.C.  
**R71V** 7x75 BT.B.C.

# Patina

120x120 - 47<sup>1/4</sup>"x47<sup>1/4</sup>" 75x150 - 29<sup>1/2</sup>"x59<sup>1/8</sup>" 75x75 - 29<sup>1/2</sup>"x29<sup>1/2</sup>" 60x60 - 23<sup>5/8</sup>"x23<sup>5/8</sup>" 30x60 - 11<sup>13/16</sup>"x23<sup>5/8</sup>" 37,5x37,5 - 14<sup>3/4</sup>"x14<sup>3/4</sup>" 30x30 - 11<sup>13/16</sup>"x11<sup>13/16</sup>"

## Decors



R19Q 75x75 Decoro Cera-Petrolio



R19R 75x75 Decoro Crema-Cognac

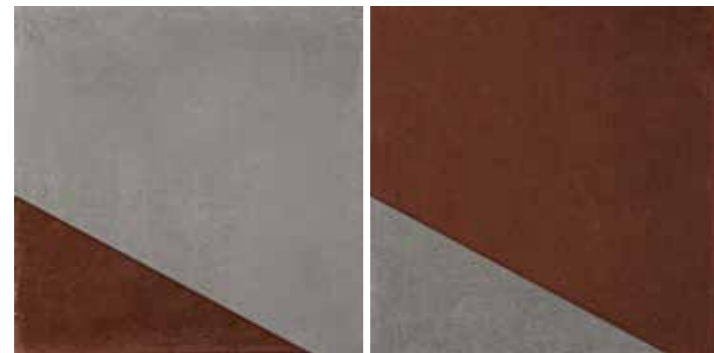

R19S 75x75 Decoro Cognac-Marsala



R19U 75x75 Decoro Petrolio-Marsala

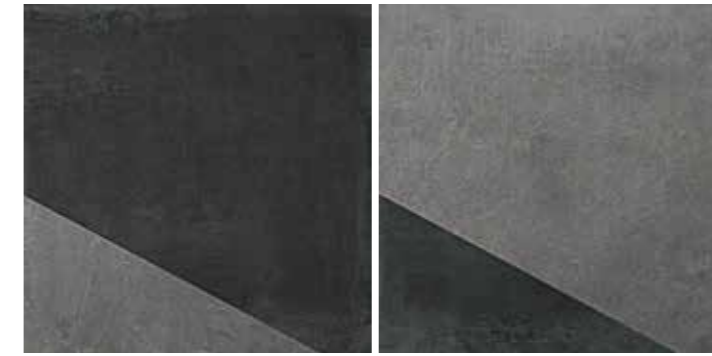

R19T 75x75 Decoro Asfalto-Petrolio



R19P 37,5x37,5 Mosaico Pop Cognac

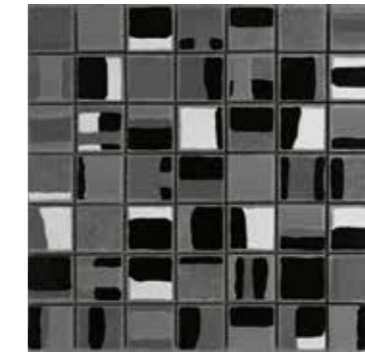

R71G 37,5x37,5 Mosaico Pop Asfalto



R71H 37,5x37,5 Mosaico Pop Petrolio

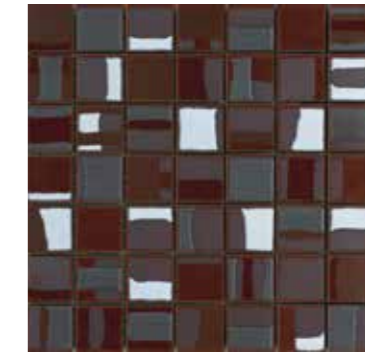

R71J 37,5x37,5 Mosaico Pop Marsala



# Patina

120x120 - 47<sup>1/4</sup> x 47<sup>1/4</sup> 75x150 - 29<sup>1/2</sup> x 59<sup>1/8</sup> 75x75 - 29<sup>1/2</sup> x 29<sup>1/2</sup> 60x60 - 23<sup>5/8</sup> x 23<sup>5/8</sup> 30x60 - 11<sup>13/16</sup> x 23<sup>5/8</sup> 37,5x37,5 - 14<sup>3/4</sup> x 14<sup>3/4</sup> 30x30 - 11<sup>13/16</sup> x 11<sup>13/16</sup>

## Decors



**R71C** 30x30 Mosaico Cera

Abbinabile ai colori / Matching with colours / Mit den Grundfliesen kombinierbar / Peut s'associer aux carreaux de base de couleurs / Puede combinarse con los fondos / Сочетается с фоновой плиткой



**Cera Crema**

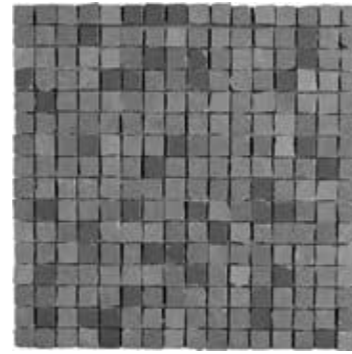

**R71D** 30x30 Mosaico Asfalto

Abbinabile ai colori / Matching with colours / Mit den Grundfliesen kombinierbar / Peut s'associer aux carreaux de base de couleurs / Puede combinarse con los fondos / Сочетается с фоновой плиткой



**Cognac Asfalto**

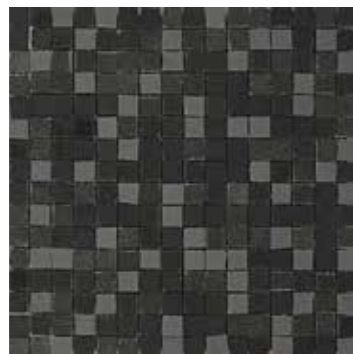

**R71E** 30x30 Mosaico Petrolio

Abbinabile ai colori / Matching with colours / Mit den Grundfliesen kombinierbar / Peut s'associer aux carreaux de base de couleurs / Puede combinarse con los fondos / Сочетается с фоновой плиткой



**Petrolio**

## TECH INFO

VARIAZIONI CROMATICHE / COLOUR VARIATIONS / FARBVARIATIONEN / VARIATIONS CHROMATIQUES / VARIACIONES CROMÁTICAS / ВАРИАНТЫ ОТТЕККА



**V2**  
Apprezzabili differenze nell'aspetto di superficie e grafica all'interno della stessa produzione / Clearly distinguishable differences in texture and pattern within the same production run / Auffällige Unterschiede in Aussehen und Struktur innerhalb der gleichen Produktionscharge / Différences visibles au niveau de l'aspect et de la fantaisie entre les carreaux du même lot de production / Diferencias visibles en el aspecto de la superficie y los motivos dentro de un mismo lote de producción / заметные отличия вида поверхности и графики в одной и той же партии

DESTINAZIONE D'USO / INTENDED USE / ANWENDUNGSBEREICH / CHAMP D'APPLICATION / USO PREVISTO / НАЗНАЧЕНИЕ

### F (Marsala: Naturale/Matt)

Materiali consigliati per qualsiasi locale di un'abitazione che non abbia collegamenti diretti con l'esterno o accessi non protetti da zerbini. Medie sollecitazioni all'abrasione / Tiles suitable for any room of a house without direct access from the outside or access not protected by doormats. Mean stress abrasive wear / Für alle Räume des Wohnbereichs empfohlen, zu denen man keinen direkten Zutritt von außen hat oder welche nicht durch Fußteppiche abgegrenzt sind. Mittlere Abriebbeanspruchung / Matériaux conseillés pour toutes les pièces d'une maison qui n'a pas d'accès directs par l'extérieur ou non protégés par des paillasons. Abrasion sous contraintes moyennes / Materiales aconsejados para cualquier habitación de una vivienda sin accesos directos desde el exterior o accesos no protegidos por felpudos. Esfuerzos medianos por abrasión / Materiales recomendados para cualquier habitación de una vivienda sin accesos directos desde el exterior o accesos no protegidos por felpudos. Esfuerzos medianos por abrasión / Материалы рекомендуются для любых жилых помещений, не имеющих прямого выхода на улицу или же доступа без входных ковриков. Среднее абразивное воздействие.

### G (Crema, Cognac, Asfalto, Petrolio: Naturale/Matt)

Materiali consigliati per locali sottoposti a sollecitazioni all'abrasione medio pesanti come: case individuali, commerciale leggero / Materials recommended for premises with medium-heavy abrasion levels, such as: detached homes, light-traffic commercial premises / Empfohlen für Räume mit mittelschwerer Abriebbeanspruchung wie: Einfamilienhäuser, leicht beanspruchte Gewerbebereiche / Matériaux recommandés pour des locaux soumis à des contraintes d'abrasion moyennes et fortes comme : maisons particulières, espaces commerciaux soumis à un trafic léger, etc / Materiales recomendados para locales sometidos a esfuerzos de abrasión medio-pesados, como casas unifamiliares y locales comerciales de tráfico ligero / Материалы рекомендуются для использования в частных домах и коммерческих помещениях, подверженных средне-сильному абразивному воздействию

### H (Cera: Naturale/Matt)

Materiali consigliati per sollecitazioni all'abrasione relativamente forti in ambienti anche non protetti da agenti graffianti / Materials recommended for relatively heavy abrasion levels, also in premises not protected against abrasive substances / Materials recommended for relatively heavy abrasion levels, also in premises not protected against abrasive substances / Empfohlen für starke Abriebbeanspruchungen in Bereichen

auch ohne Kratzschutzbehandlung / Matériaux recommandés pour des locaux soumis à des fortes contraintes d'abrasion, même non protégés contre les agents abrasifs / Materiales recomendados para soportar esfuerzos de abrasión relativamente intensos incluso en espacios no protegidos frente a agentes abrasivos / Материалы рекомендованы для относительно сильного абразивного воздействия, в том числе в помещениях, не защищенных от царапающих элементов

DECORI / DECORATIVE PIECES / DEKORE / DÉCORS / DECORACIONES / ДЕКОРЫ

### Mosaico Pop

Decoro con lustri/metalli preziosi utilizzabile a rivestimento; si consiglia la pulizia con detergenti neutri, non abrasivi. È sconsigliata la posa nell'area doccia / Decors with lustres/precious metals used for covering; we recommend cleaning with neutral, non-abrasive detergents. Tiles should not be installed in the shower area / Dekor mit Glanzelementen/Edelmetallen für die Wandverkleidung; es wird die Reinigung mit neutralen, scheuermittelfreien Reinigungsmitteln empfohlen. Die Verlegung in der Duschnische wird nicht empfohlen / Décor avec lustres/métaux précieux à poser sur le mur. Lavage recommandé avec des détergents neutres, non abrasifs. Pose déconseillée dans la douche / Decoración con elementos brillantes/metales preciosos utilizable para revestir superficies; se recomienda limpiarla con detergentes neutros, no abrasivos. Se desaconseja colocarla en el área de la ducha / Декор с блестящим покрытием/драгоценными металлами, используемый для облицовки; рекомендуется чистка с использованием нейтральных, неабразивных моющих средств. Не рекомендуется укладка в душевой зоне

### Mosaico

Mosaico assemblato su rete in fibra di vetro / Mosaic mesh - mounted on fibreglass / Auf Glasfasernetz geklebtes Mosaik / Mosaïque montée sur filet en fibre de verre / Mosaico enmallado sobre fibra de vidrio / Мозаика, собранная на сетке из стекловолокна

### Decoro

Decoro assemblato con tratto plastico / Spot-bonded Decors / Punktverklebtes Dekore / Décors montée avec trait de colle / Decorados colocado aplicando cola plástica / Декоры с сегментами, выполненными из пластмассы - Мозаика, собранная на клеевой точке

Decori su richiesta e coordinabili ai fondi rettificati / Decors are available upon request and can be matched with the rectified plain tiles / Dekore sind auf Anfrage erhältlich und mit den rektifizierten Grundfliesen kombinierbar / Les décors sont disponibles sur demande et coordonnables aux fonds rectifiés / Decorados disponibles bajo pedido y coordinables con las bases rectificadas / Декоры поставляются по заказу и предназначены для сочетания с обрезной фоновой плиткой

PEZZI SPECIALI / TRIMS / SPEZIALTEILE / PIÈCES SPÉCIALES / PIEZAS ESPECIALES / СПЕЦИАЛЬНЫЕ ИЗДЕЛИЯ

### BT.B.C.

Battiscopa Becco Civetta ottenuto da taglio del fondo / Coved Edge Skirting Tile cut from plain tile / Sockelleiste, Halbrundstab, aus Grundfliese geschnitten / Plinthe bord rond découpée dans le fond / Rodapié canto romo conseguido mediante corte del fondo / Плинтус с закругленным краем, полученный из фоновой плитки

CARATTERISTICHE / CHARACTERISTICS / EIGENSCHAFTEN / CARACTERISTIQUES / DATOS / ХАРАКТЕРИСТИКИ

	<b>R9</b> Naturale/Matt	<b>PENDULUM</b> classe 1 Naturale/Matt	<b>D-COF</b> > <b>0,42</b> Naturale/ Matt	<b>BCR</b> <b>μ &gt; 0,40</b> Naturale/ Matt
	≤ 175 mm <sup>3</sup>			



IMBALLI / PACKAGING / VERPACKUNGEN / EMBALLAGES / EMBALAJES / УПАКОВКИ

	scatole / box / karton / boîte / caja / коробк			pallet / pallet / palette / palette / pallet / поддон			
	□	M <sup>2</sup>	KG	□	M <sup>2</sup>	KG	± mm
120x120	1	1,44	37,00	36	51,84	1351,36	10,5
75x150	2	2,25	51,81	21	47,25	1088,00	9,5
75x75	2	1,13	23,81	42	47,25	1000,00	9,5
60x60	3	1,08	22,62	40	43,20	904,71	10
30x60	6	1,08	22,48	48	51,84	1079,10	10
75x75	2	1,125	27,00	10	11,250	286,00	9,5
37,5x37,5	4	0,563	8,00	60	33,751	503,00	9,5
30x30	4	0,36	9,60	80	28,80	767,99	10
7x75	14	10,50 ml	18,87	-	-	-	9,5
7x60	15	9,00 ml	18,18	-	-	-	10

CONCRETE EFFECT

# Boom



R53K Calce Rettificato 75x75 - 29<sup>1/2</sup>"x29<sup>1/2</sup>" - R54Q Mosaico Luce 30x30 - 11<sup>13/16</sup>"x11<sup>13/16</sup>"



## Boom

gres fine porcellanato colorato in massa - rettificato monocalibro / colorbody fine porcelain stoneware - rectified monocaliber / durchgefärbtes feinsteinzeug - rektifiziert, in einem werkmaß / grès cérame fin coloré dans la masse - rectifié monocalibre / gres porcelánico fino coloreado en toda la masa - rectificado monocalibre / гомогенный мелкозернистый керамогранит - ректифицированный монокалиберный

gruppo Bla UNI EN 14411\_G



naturale/  
matt outdoor



75x150 cm  
29<sup>1/2</sup>"x59<sup>1/8</sup>"  
± 9,5 mm

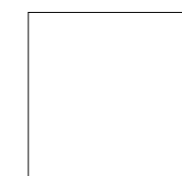

75x75 cm  
29<sup>1/2</sup>"x29<sup>1/2</sup>"  
± 9,5 mm

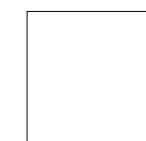

60x60 cm  
23<sup>5/8</sup>"x23<sup>5/8</sup>"  
± 9,5 mm



30x60 cm  
11<sup>13/16</sup>"x23<sup>5/8</sup>"  
± 9,5 mm

# Boom

75x150 - 29<sup>1/2</sup>"x59<sup>1/8</sup>" 75x75 - 29<sup>1/2</sup>"x29<sup>1/2</sup>" 44,9x61,6 - 17<sup>11/16</sup>"x24<sup>1/4</sup>" 60x60 - 23<sup>5/8</sup>"x23<sup>5/8</sup>" 30x60 - 11<sup>13/16</sup>"x23<sup>5/8</sup>" 30x30 - 11<sup>13/16</sup>"x11<sup>13/16</sup>"

## Sabbia



**R00A** 75x150 Rett  
**R53J** 75x75 Rett  
**R54G** 60x60 Rett  
**R00G** 60x60 Strutt Rett  
**R13S** 30x60 Rett



**R13X** 30x30 Mosaico



**R54L** 7x60 BT.B.C.  
**R53P** 7x75 BT.B.C.

## Acciaio



**R00D** 75x150 Rett  
**R53L** 75x75 Rett  
**R54H** 60x60 Rett  
**R00J** 60x60 Strutt Rett  
**R13C** 30x60 Rett



**R13V** 30x30 Mosaico



**R54N** 7x60 BT.B.C.  
**R53R** 7x75 BT.B.C.

## Calce



**R00C** 75x150 Rett  
**R53K** 75x75 Rett  
**R54F** 60x60 Rett  
**R00H** 60x60 Strutt Rett  
**R13T** 30x60 Rett



**R13Y** 30x30 Mosaico



**R54M** 7x60 BT.B.C.  
**R53Q** 7x75 BT.B.C.

## Piombo

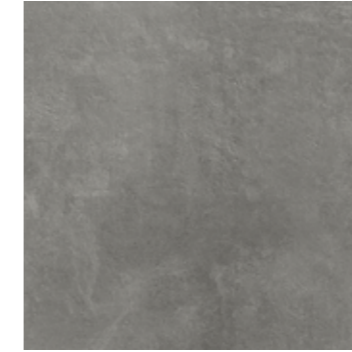

**R00E** 75x150 Rett  
**R53M** 75x75 Rett  
**R54J** 60x60 Rett  
**R00K** 60x60 Strutt Rett  
**R13D** 30x60 Rett



**R13W** 30x30 Mosaico



**R54P** 7x60 BT.B.C.  
**R53S** 7x75 BT.B.C.

## Luce



**R000** 75x150 Rett  
**R53H** 75x75 Rett  
**R54E** 60x60 Rett  
**R00F** 60x60 Strutt Rett  
**R13A** 30x60 Rett



**R13U** 30x30 Mosaico



**R54K** 7x60 BT.B.C.  
**R53N** 7x75 BT.B.C.

# Boom

75x150 - 29<sup>1/2</sup> x 59<sup>1/8</sup> 75x75 - 29<sup>1/2</sup> x 29<sup>1/2</sup> 44,9x61,6 - 17<sup>11/16</sup> x 24<sup>1/4</sup> 60x60 - 23<sup>5/8</sup> x 23<sup>5/8</sup> 30x60 - 11<sup>13/16</sup> x 23<sup>5/8</sup> 30x30 - 11<sup>13/16</sup> x 11<sup>13/16</sup>

## Decors

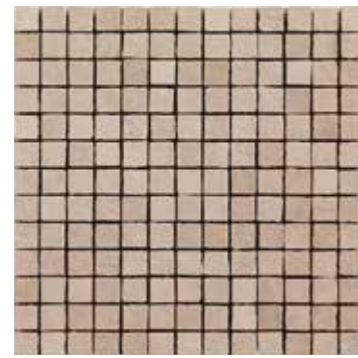

R54R 30x30 Mosaico Sabbia

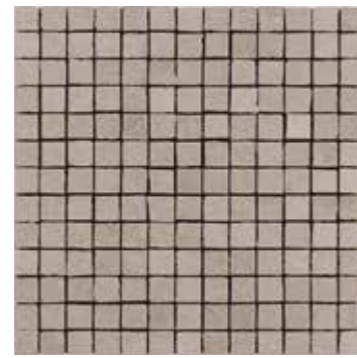

R54S 30x30 Mosaico Calce

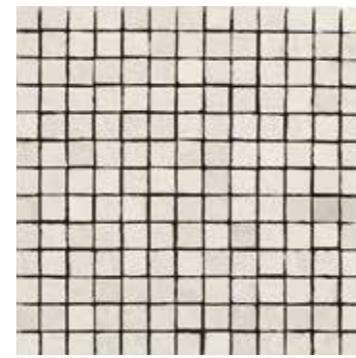

R54Q 30x30 Mosaico Luce

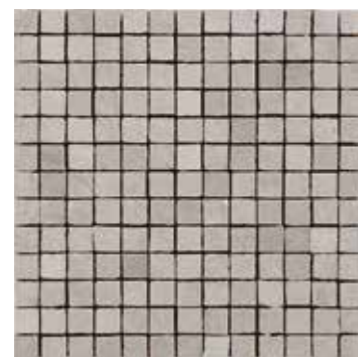

R54T 30x30 Mosaico Acciaio

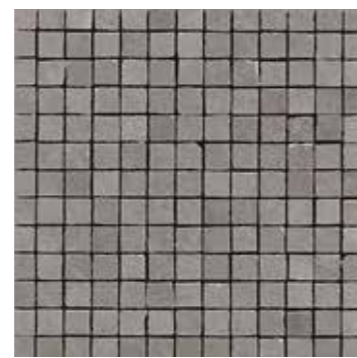

R54U 30x30 Mosaico Piombo



R02E 44,9x61,6 Mosaico Sabbia



R02F 44,9x61,6 Mosaico Calce



R02G 44,9x61,6 Mosaico Acciaio



R02H 44,9x61,6 Mosaico Piombo

## TECH INFO

VARIAZIONI CROMATICHE / COLOUR VARIATIONS / FARBVARIATIONEN / VARIATIONS CHROMATIQUES / VARIACIONES CROMÁTICAS / ВАРИАНТЫ ОТТЕНКА



Significativa variazione di aspetto superficiale, grafica e colore da piastrella a piastrella e all'interno della stessa piastrella. Si consiglia di visionare la gamma cromatica prima della selezione del materiale / Significant variation in texture, pattern and colour from tile to tile within the same production run. The colour range should be viewed before selecting the material / Bedeutende Variation in Aussehen, Struktur und Farbe von Fliese zu Fliese und in ein und derselben Fliese. Es wird empfohlen, das Farbsortiment vor der Auswahl des Materials zu prüfen / Variation significative au niveau de l'aspect, de la fantaisie et de la couleur entre les carreaux et au sein d'un même carreau. Il est recommandé de consulter la gamme des couleurs avant de sélectionner le matériel / Variación considerable en el aspecto superficial, los motivos y el color entre un azulejo y otro y dentro del propio azulejo. Es aconsejable visualizar la gama cromática antes de seleccionar el material / Значительные отличия вида поверхности, графики и цвета у разных плиток и на одной и той же плитке. Перед отбором материала рекомендуется посмотреть цветовую гамму

DESTINAZIONE D'USO / INTENDED USE / ANWENDUNGSBEREICH / CHAMP D'APPLICATION / USO PREVISTO / НАЗНАЧЕНИЕ

### H (Naturale/Matt, Strutturato)

Materiali consigliati per sollecitazioni all'abrasione relativamente forti in ambienti anche non protetti da agenti graffianti / Materials recommended for relatively heavy abrasion levels, also in premises not protected against abrasive substances / Materials recommended for relatively heavy abrasion levels, also in premises not protected against abrasive substances / Empfohlen für starke Abriebbeanspruchungen in Bereichen auch ohne Kratzschutzbehandlung / Matériaux recommandés pour des locaux soumis à des fortes contraintes d'abrasion, même non protégés contre les agents abrasifs / Materiales recomendados para soportar esfuerzos de abrasión relativamente intensos incluso en espacios no protegidos frente a agentes abrasivos / Материалы рекомендованы для относительно сильного абразивного воздействия, в том числе в помещениях, не защищенных от царапающих элементов

DECORI / DECORATIVE PIECES / DEKORE / DÉCORS / DECORACIONES / ДЕКОРЫ

### Mosaico

Mosaico assemblato su rete in fibra di vetro / Mosaic mesh - mounted on fibreglass / Auf Glasfasernetz geklebtes Mosaik / Mosaïque montée sur filet en fibre de verre / Mosaico enmallado sobre fibra de vidrio / Мозаика, собранная на сетке из стекловолокна

CARATTERISTICHE / CHARACTERISTICS / EIGENSCHAFTEN / CARACTERISTIQUES / DATOS / ХАРАКТЕРИСТИКИ

	R9 Naturale/Matt R11 Strutturato	PENDULUM classe 1 Naturale/Matt classe 3 Strutturato ptv > 36 Strutturato	D-COF > 0,42	BCR μ > 0,40
	B Strutturato			
	≤ 175 mm <sup>2</sup>			

CERTIFICAZIONI / CERTIFICATIONS / ZERTIFIZIERUNGEN / CERTIFICACIONES / СЕРТИФИКАЦИИ



IMBALLI / PACKAGING / VERPACKUNGEN / EMBALLAGES / EMBALAJES / УПАКОВКИ

	scatole / box / karton / boîte / caja / коробк			pallet / pallet / palette / palette / pallet / поддон				
	□	M <sup>2</sup>	KG	□	M <sup>2</sup>	KG	± mm	
75x150	2	2,25	51,81	21	47,25	1088,00	9,5	
75x75	2	1,13	23,81	42	47,25	1000,00	9,5	
60x60	3	1,08	26,22	40	43,20	1048,82	9,5	
30x60	6	1,08	26,22	48	51,84	1048,82	9,5	
44,9x61,6	Mosaico	4	0,68	10,50	20	13,48	210,00	9,5
30x30	Mosaico 5x5	4	0,36	7,51	80	28,80	600,66	9,5
30x30	Mosaico	4	0,36	7,55	80	28,80	603,86	9,5
7x75	BT.B.C.	14	10,50 ml	18,87	-	-	9,5	
7x60	BT.B.C.	15	9,00 ml	18,18	-	-	9,5	

CONCRETE EFFECT

# Rewind



R4AW Argilla Rettificato 75x75 - 29<sup>1/2</sup> x 29<sup>1/2</sup> - R4DV Decoro Cementine 21x18,2 - 8<sup>1/4</sup> x 7<sup>3/16</sup>



## Rewind

gres fine porcellanato colorato in massa - rettificato monocalibro / colorbody fine porcelain stoneware - rectified monocaliber / durchgefärbtes feinsteinzeug - rektifiziert, in einem werkmaß / grès cérame fin coloré dans la masse - rectifié monocalibre / gres porcelánico fino coloreado en toda la masa - rectificado monocalibre / гомогенный мелкозернистый керамогранит - ректифицированный монокалиберный

45x45

gres fine porcellanato colorato in massa / colorbody fine porcelain stoneware / durchgefärbtes feinsteinzeug / grès cérame fin coloré dans la masse / gres porcelánico fino coloreado en toda la masa / гомогенный мелкозернистый керамогранит

21x18,2 - 7x28

gres porcellanato / porcelain stoneware / feinsteinzeug / grès cérame émaillé / gres porcelánico / керамогранит

gruppo Bla UNI EN 14411\_G



naturale/  
matt

<b>90x90 cm</b> 35 <sup>3/16</sup> x 35 <sup>3/16</sup> ± 10,5 mm	<b>75x75 cm</b> 29 <sup>1/2</sup> x 29 <sup>1/2</sup> ± 9,5 mm	<b>60x120 cm</b> 23 <sup>5/8</sup> x 47 <sup>1/4</sup> ± 10 mm	<b>60x60 cm</b> 23 <sup>5/8</sup> x 23 <sup>5/8</sup> ± 10 mm	<b>30x60 cm</b> 11 <sup>13/16</sup> x 23 <sup>5/8</sup> ± 10 mm	<b>45x45 cm</b> 17 <sup>11/16</sup> x 17 <sup>11/16</sup> ± 9 mm	<b>21x18,2 cm</b> 8 <sup>1/4</sup> x 7 <sup>3/16</sup> ± 9,5 mm	<b>7x28 cm</b> 2 <sup>3/4</sup> x 11 <sup>1/8</sup> ± 9 mm

**XT20**  
**Rewind XT20**  
> p.464  
**WALL TILES**  
**Rewind Wall**  
> p.560

# Rewind

90x90 - 35<sup>7/16</sup> x 35<sup>7/16</sup> 75x75 - 29<sup>1/2</sup> x 29<sup>1/2</sup> 60x120 - 23<sup>5/8</sup> x 47<sup>1/4</sup> 60x60 - 23<sup>5/8</sup> x 23<sup>5/8</sup> 30x60 - 11<sup>13/16</sup> x 23<sup>5/8</sup> 45x45 - 17<sup>11/16</sup> x 17<sup>11/16</sup> 21x18,2 - 8<sup>1/4</sup> x 7<sup>3/16</sup> 7x28 - 2<sup>3/4</sup> x 11<sup>1/16</sup>

## Vanilla



**R4KY** 7x28 Rett



**R4CM** 21x18,2

**R4KL** 90x90 Rett  
**R4AS** 75x75 Rett  
**R4DX** 60x120 Rett  
**R4AY** 60x60 Rett  
**R4CF** 30x60 Rett  
**R4JX** 45x45



**R4EN** 7x60 BT.B.C.  
**R4EU** 7x75 BT.B.C.  
**R4KE** 8x45 BT.B.C.



**R4FX** 32,5x60 GR.

## Corda



**R4LE** 7x28 Rett



**R4CS** 21x18,2

**R4KR** 90x90 Rett  
**R4AX** 75x75 Rett  
**R4EA** 60x120 Rett  
**R4CE** 60x60 Rett  
**R4CL** 30x60 Rett  
**R4KD** 45x45



**R4ET** 7x60 BT.B.C.  
**R4EZ** 7x75 BT.B.C.  
**R4KK** 8x45 BT.B.C.

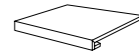

**R4GA** 32,5x60 GR.

## Polvere



**R4KZ** 7x28 Rett



**R4CN** 21x18,2

**R4KM** 90x90 Rett  
**R4AT** 75x75 Rett  
**R4DY** 60x120 Rett  
**R4AZ** 60x60 Rett  
**R4CG** 30x60 Rett  
**R4JY** 45x45



**R4EP** 7x60 BT.B.C.  
**R4EV** 7x75 BT.B.C.  
**R4KF** 8x45 BT.B.C.



**R4FY** 32,5x60 GR.

## Argilla



**R4LD** 7x28 Rett



**R4CR** 21x18,2

**R4KQ** 90x90 Rett  
**R4AW** 75x75 Rett  
**R4DZ** 60x120 Rett  
**R4CD** 60x60 Rett  
**R4CK** 30x60 Rett  
**R4KC** 45x45



**R4ES** 7x60 BT.B.C.  
**R4EY** 7x75 BT.B.C.  
**R4KJ** 8x45 BT.B.C.



**R4GB** 32,5x60 GR.

## Peltro



**R4LA** 7x28 Rett



**R4CP** 21x18,2

**R4KN** 90x90 Rett  
**R4AU** 75x75 Rett  
**R4CA** 60x60 Rett  
**R4CH** 30x60 Rett  
**R4JZ** 45x45



**R4EQ** 7x60 BT.B.C.  
**R4EW** 7x75 BT.B.C.  
**R4KG** 8x45 BT.B.C.



**R4FZ** 32,5x60 GR.

## Tabacco



**R4LC** 7x28 Rett



**R4CQ** 21x18,2

**R4KP** 90x90 Rett  
**R4AV** 75x75 Rett  
**R4CC** 60x60 Rett  
**R4CJ** 30x60 Rett  
**R4KA** 45x45



**R4ER** 7x60 BT.B.C.  
**R4EX** 7x75 BT.B.C.  
**R4KH** 8x45 BT.B.C.



**R4G5** 32,5x60 GR.

# Rewind

90x90 - 35<sup>7/16</sup> x 35<sup>7/16</sup> 75x75 - 29<sup>1/2</sup> x 29<sup>1/2</sup> 60x120 - 23<sup>5/8</sup> x 47<sup>1/4</sup> 60x60 - 23<sup>5/8</sup> x 23<sup>5/8</sup> 30x60 - 11<sup>13/16</sup> x 23<sup>5/8</sup> 45x45 - 17<sup>11/16</sup> x 17<sup>11/16</sup> 21x18,2 - 8<sup>1/4</sup> x 7<sup>5/16</sup> 7x28 - 2<sup>3/4</sup> x 11<sup>1/16</sup>

## Decors



**R4DU** 21x18,2 Decoro geometrico Corda

Abbinabile ai colori / Matching with colours / Mit den Grundfliesen kombinierbar / Peut s'associer aux carreaux de base de couleurs / Puede combinarse con los fondos / Сочетается с фоновой плиткой



**Corda** **Tabacco** **Argilla**



**R4DT** 21x18,2 Decoro geometrico Vanilla

Abbinabile ai colori / Matching with colours / Mit den Grundfliesen kombinierbar / Peut s'associer aux carreaux de base de couleurs / Puede combinarse con los fondos / Сочетается с фоновой плиткой

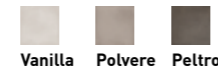

**Vanilla** **Polvere** **Peltro**

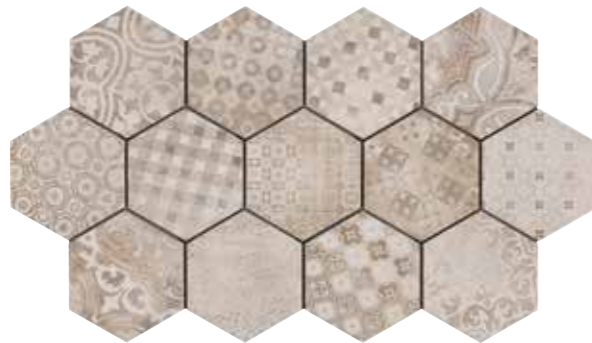

**R4DV** 21x18,2 Decoro Cementine

## TECH INFO

VARIAZIONI CROMATICHE / COLOUR VARIATIONS / FARBVARIATIONEN / VARIATIONS CHROMATIQUES / VARIACIONES CROMÁTICAS / ВАРИАНТЫ ОТТЕНКА



Apprezzabili differenze nell'aspetto di superficie e grafica all'interno della stessa produzione / Clearly distinguishable differences in texture and pattern within the same production run / Auffällige Unterschiede in Aussehen und Struktur innerhalb der gleichen Produktionscharge / Différences visibles au niveau de l'aspect et de la fantaisie entre les carreaux du même lot de production / Diferencias visibles en el aspecto de la superficie y los motivos dentro de un mismo lote de producción / заметные отличия вида поверхности и графики в одной и той же партии

DESTINAZIONE D'USO / INTENDED USE / ANWENDUNGSBEREICH / CHAMP D'APPLICATION / USO PREVISTO / НАЗНАЧЕНИЕ

**G (7x28 Polvere, 7x28 Peltro, 7x28 Tabacco: Naturale/Matt)**

Materiali consigliati per locali sottoposti a sollecitazioni all'abrasione medio pesanti come: case individuali, commerciale leggero / Materials recommended for premises with medium-heavy abrasion levels, such as: detached homes, light-traffic commercial premises / Empfohlen für Räume mit mittelschwerer Abriebbeanspruchung wie: Einfamilienhäuser, leicht beanspruchte Gewerbebereiche / Matériaux recommandés pour des locaux soumis à des contraintes d'abrasion moyennes et fortes comme : maisons particulières, espaces commerciaux soumis à un trafic léger, etc / Materiales recomendados para locales sometidos a esfuerzos de abrasión medio-pesados, como casas unifamiliares y locales comerciales de tráfico ligero / Материалы рекомендованы для использования в частных домах и коммерческих помещениях, подверженных средне-сильному абразивному воздействию

**H (Naturale/Matt)**

Materiali consigliati per sollecitazioni all'abrasione relativamente forti in ambienti anche non protetti da agenti graffianti / Materials recommended for relatively heavy abrasion levels, also in premises not protected against abrasive substances / Materials recommended for relatively heavy abrasion levels, also in premises not protected against abrasive substances / Empfohlen für starke Abriebbeanspruchungen in Bereichen auch ohne Kratzschutzbehandlung / Matériaux recommandés pour des locaux soumis à des fortes contraintes d'abrasion, même non protégés contre les agents abrasifs / Materiales recomendados para soportar esfuerzos de abrasión relativamente intensos incluso en espacios no protegidos frente a agentes abrasivos / Материалы рекомендованы для относительно сильного абразивного воздействия, в том числе в помещениях, не защищенных от царапающих элементов

DECORI / DECORATIVE PIECES / DEKORE / DÉCORS / DECORACIONES / ДЕКОРЫ

**Decoro Geometrico**

18 diversi soggetti / 18 different motifs / 18 verschiedene Motive / 18 sujets différents / 18 temas diferentes / 18 различных рисунка

**Decoro Cementine**

13 diversi soggetti / 13 different motifs / 13 verschiedene Motive / 13 sujets différents / 13 temas diferentes / 13 различных рисунка

PEZZI SPECIALI / TRIMS / SPEZIALTEILE / PIÈCES SPÉCIALES / PIEZAS ESPECIALES / СПЕЦИАЛЬНЫЕ ИЗДЕЛИЯ

**BT.B.C.**

Battiscopa Becco Civetta ottenuto da taglio del fondo / Coved Edge Skirting Tile cut from plain tile / Sockelleiste, Halbrundstab, aus Grundfliese geschnitten / Plinthe bord rond découpée dans le fond / Rodapié canto romo conseguido mediante corte del fondo / Плинтус с закругленным краем, полученный из фоновой плитки

**BT.B.C. (8x45)**

Battiscopa Becco Civetta ottenuto per pressatura / Press-formed Coved Edge Skirting Tile / Sockelleiste, Halbrundstab, gepresst / Plinthe bord rond obtenue par pressage / Rodapié canto romo conseguido mediante prensado / Плинтус с закругленным краем, полученный прессованием

**GR.**

Gradone lineare tagliato ed assemblato / Two-piece straight step / Stufenplatte gerade geschnitten und zusammengesetzt / Large marche droite coupée et assemblée / Escalón lineal cortado y montado / Собранный загибающаяся линейная ступень со срезом

CARATTERISTICHE / CHARACTERISTICS / EIGENSCHAFTEN / CARACTERISTIQUES / DATOS / ХАРАКТЕРИСТИКИ

<b>R9</b>	<b>PENDULUM</b>	<b>D-COF</b>	<b>BCR</b>
<b>R10</b> 7x28 Strutturato	<b>classe 1</b>	<b>&gt; 0,42</b>	<b>μ &gt; 0,40</b>
	<b>ptv &gt; 36</b> 90x90 - 60x120 - 75x75 - 60x60 - 30x60 - 45x45 - 21x18,2 Esagona -		21x18,2 - 7x28 Strutturato

**B** 7x28 Strutturato

≤ 175 mm<sup>2</sup>

CERTIFICAZIONI / CERTIFICATIONS / ZERTIFIZIERUNGEN / CERTIFICACIONES / СЕРТИФИКАЦИИ



IMBALLI / PACKAGING / VERPACKUNGEN / EMBALLAGES / EMBALAJES / УПАКОВКИ

		scatole / box / karton / boîte / caja / короб			pallet / pallet / palette / palette / pallet / поддон			
			M <sup>2</sup>	KG		M <sup>2</sup>	KG	± mm
90x90	Rettificato	2	1,62	40,99	24	38,88	984,00	10,5
75x75	Rettificato	2	1,13	23,81	42	47,25	1000,00	9,5
60x120	Rettificato	2	1,44	32,82	36	51,84	1181,67	10
60x60	Rettificato	3	1,08	23,15	40	43,20	926,05	10
30x60	Rettificato	5	0,90	19,16	48	43,20	919,74	10
45x45		5	1,01	20,00	33	33,41	662,19	9
21x18,2		16	0,46	9,64	100	45,86	963,88	9,5
7x28		50	0,98	19,18	52	50,96	997,11	9
7x60	BT.B.C	15	9,00 ml	18,18	-	-	-	10
7x75	BT.B.C	14	10,50 ml	18,87	-	-	-	9,5
8x45	BT.B.C	30	13,50 ml	21,30	-	-	-	9
32,5x60	GR.	4	0,78	21,07	-	-	-	-

CONCRETE EFFECT

# Concept



R28M Greige Rettificato 15x60 - 5<sup>7/8</sup>"x23<sup>5/8</sup>" - R287 Greige Rettificato 60x60 - 23<sup>5/8</sup>"x23<sup>5/8</sup>"



## Concept

**Beige, Greige, Fango, Grigio, Nero**  
 gres fine porcellanato colorato in massa - rettificato monocalibro / colorbody fine porcelain stoneware - rectified monocaliber/ durchgefärbtes feinsteinzeug - rektifiziert, in einem werkmaß / grès cérame fin coloré dans la masse - rectifié monocalibre / gres porcelánico fino coloreado en toda la masa - rectificado monocalibre / гомогенный мелкозернистый керамогранит - ректифицированный монокалиберный

**Bianco**  
 gres porcellanato - rettificato monocalibro / porcelain stoneware - rectified monocaliber / feinsteinzeug - rektifiziert, in einem werkmaß / grès cérame émaillé - rectifié monocalibre / gres porcelánico - rectificado monocalibre / керамогранит - ректифицированный монокалиберный

**45x45**  
 gres porcellanato / porcelain stoneware / feinsteinzeug / grès cérame émaillé / gres porcelánico / керамогранит

gruppo **Bla UNI EN 14411\_G**



**10x10**  
 gres porcellanato / porcelain stoneware / feinsteinzeug / grès cérame émaillé / gres porcelánico / керамогранит

gruppo **Bla UNI EN 14411\_G**



<b>60x120 cm</b> 23 <sup>5/8</sup> "x47 <sup>1/4</sup> " ± 9,5 mm	<b>30x120 cm</b> 11 <sup>13/16</sup> "x47 <sup>1/4</sup> " ± 9,5 mm	<b>75x75 cm</b> 29 <sup>1/2</sup> "x29 <sup>1/2</sup> " ± 9,5 mm	<b>37,5x75 cm</b> 14 <sup>3/4</sup> "x29 <sup>1/2</sup> " ± 9,5 mm	<b>60x60 cm</b> 23 <sup>5/8</sup> "x23 <sup>5/8</sup> " ± 9,5 mm	<b>30x60 cm</b> 11 <sup>13/16</sup> "x23 <sup>5/8</sup> " ± 9,5 mm	<b>15x60 cm</b> 5 <sup>7/8</sup> "x23 <sup>5/8</sup> " ± 9,5 mm	<b>45x45 cm</b> 17 <sup>11/16</sup> "x17 <sup>11/16</sup> " ± 9 mm	<b>10x10 cm</b> 3 <sup>15/16</sup> "x3 <sup>15/16</sup> " ± 7 mm

**XT20**  
**Concept XT20**  
 > p.468



# Concept

60x60 - 23<sup>5/8</sup>"x23<sup>5/8</sup>" 30x60 - 11<sup>13/16</sup>"x23<sup>5/8</sup>" 60x120 - 23<sup>5/8</sup>"x47<sup>1/4</sup>" 30x120 - 11<sup>13/16</sup>"x47<sup>1/4</sup>" 75x75 - 29<sup>1/2</sup>"x29<sup>1/2</sup>" 37,5x75 - 14<sup>3/4</sup>"x29<sup>1/2</sup>" 15x60 - 5<sup>7/8</sup>"x23<sup>5/8</sup>" 45x45 - 17<sup>11/16</sup>"x17<sup>11/16</sup>" 30x30 - 11<sup>13/16</sup>"x11<sup>13/16</sup>" 10x10 - 3<sup>15/16</sup>"x3<sup>15/16</sup>"

## Beige



- R2G5 60x120 Rett
- R2JX 30x120 Rett
- R3HQ 75x75 Rett
- R3HW 37,5x75 Rett
- R285 60x60 Rett
- R28E 30x60 Rett
- R28L 15x60 Rett
- R2XV 45x45
- R37G 10x10

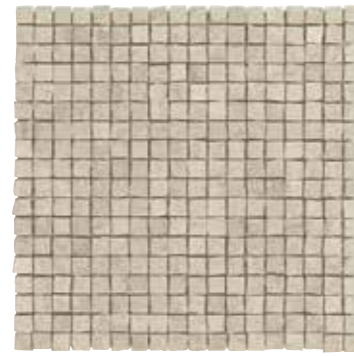

R2AW 30x30 Mosaico



- R2CE 7x60 BT.B.C.
- R3J2 7x75 BT.B.C.



- R2WT 8x45 BT.B.C.



- R2CL 32,5x60 GR.

## Bianco



- R2GR 60x120 Rett
- R2JW 30x120 Rett
- R3HP 75x75 Rett
- R3HV 37,5x75 Rett
- R284 60x60 Rett
- R28D 30x60 Rett
- R28K 15x60 Rett
- R2XU 45x45
- R37F 10x10



R2AT 30x30 Mosaico



- R2CA 7x60 BT.B.C.
- R3J1 7x75 BT.B.C.



- R2WQ 8x45 BT.B.C.



- R2CH 32,5x60 GR.

## Greige



- R2GT 60x120 Rett
- R2JY 30x120 Rett
- R3HR 75x75 Rett
- R3HX 37,5x75 Rett
- R287 60x60 Rett
- R28F 30x60 Rett
- R28M 15x60 Rett
- R2XW 45x45
- R37H 10x10



R2AX 30x30 Mosaico



- R2CF 7x60 BT.B.C.
- R3J3 7x75 BT.B.C.



- R2RK 8x45 BT.B.C.



- R2CM 32,5x60 GR.

## Grigio



- R2GU 60x120 Rett
- R2JZ 30x120 Rett
- R3HT 75x75 Rett
- R3HZ 37,5x75 Rett
- R288 60x60 Rett
- R28G 30x60 Rett
- R28N 15x60 Rett
- R2XX 45x45
- R37L 10x10

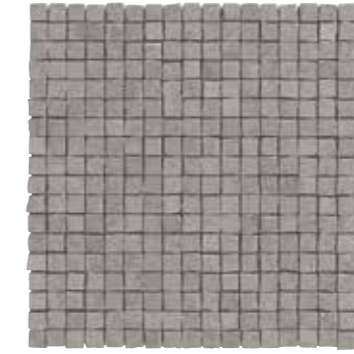

R2AU 30x30 Mosaico



- R2CC 7x60 BT.B.C.
- R3J5 7x75 BT.B.C.



- R2RL 8x45 BT.B.C.



- R2CJ 32,5x60 GR.

## Fango



- R2GV 60x120 Rett
- R2KA 30x120 Rett
- R3HS 75x75 Rett
- R3HY 37,5x75 Rett
- R28A 60x60 Rett
- R28H 30x60 Rett
- R28P 15x60 Rett
- R2WN 45x45
- R37J 10x10

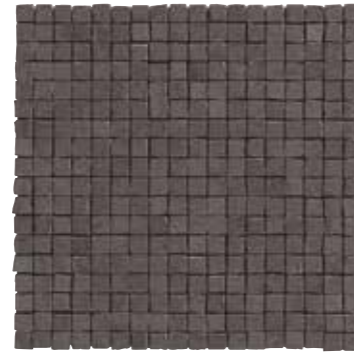

R2AY 30x30 Mosaico



- R2CG 7x60 BT.B.C.
- R3J4 7x75 BT.B.C.



- R2RM 8x45 BT.B.C.



- R2CN 32,5x60 GR.

## Nero



- R2GW 60x120 Rett
- R2KC 30x120 Rett
- R3HU 75x75 Rett
- R3J0 37,5x75 Rett
- R28C 60x60 Rett
- R28J 30x60 Rett
- R28Q 15x60 Rett
- R2WP 45x45
- R37K 10x10

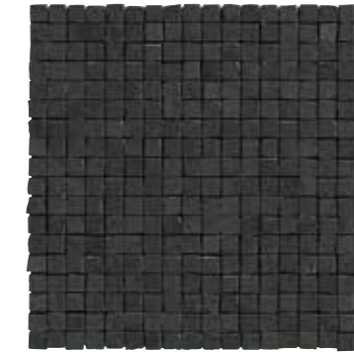

R2AV 30x30 Mosaico



- R2CD 7x60 BT.B.C.
- R3J7 7x75 BT.B.C.



- R2RN 8x45 BT.B.C.



- R2CK 32,5x60 GR.

I formati 60x60 e 30x60 rettificati sono modulari se posati con fuga 2 mm / The 60x60 and 30x60 rectified sizes can be used in modular combinations if laid with 2 mm joint / Die rektifizierten Formate 60x60 und 30x60 sind bei Verlegung mit 2-mm-Fuge modular / Les formats 60x60 et 30x60 rectifiés peuvent se combiner s'ils sont posés avec un joint de 2 mm / Los formatos de 60 x 60 y de 30 x 60 rectificadas son modulares si se colocan dejando juntas de 2 mm. / Обрезные форматы 60x60 и 30x60 могут укладываться модульно со швом 2 мм

# Concept

60x60 - 23<sup>5/8"</sup> x 23<sup>5/8"</sup> 30x60 - 11<sup>13/16"</sup> x 23<sup>5/8"</sup> 60x120 - 23<sup>5/8"</sup> x 47<sup>1/4"</sup> 30x120 - 11<sup>13/16"</sup> x 47<sup>1/4"</sup> 75x75 - 29<sup>1/2"</sup> x 29<sup>1/2"</sup> 37,5x75 - 14<sup>3/4"</sup> x 29<sup>1/2"</sup> 15x60 - 5<sup>7/8"</sup> x 23<sup>5/8"</sup> 45x45 - 17<sup>11/16"</sup> x 17<sup>11/16"</sup> 30x30 - 11<sup>13/16"</sup> x 11<sup>13/16"</sup> 10x10 - 3<sup>15/16"</sup> x 3<sup>15/16"</sup>

## Decors



**R2AP** 30x60 Decoro A Beige



**R2AR** 30x60 Decoro A Greige

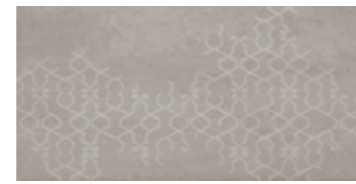

**R2AM** 30x60 Decoro A Grigio



**R2AQ** 30x60 Decoro B Beige

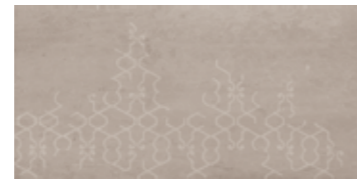

**R2AS** 30x60 Decoro B Beige

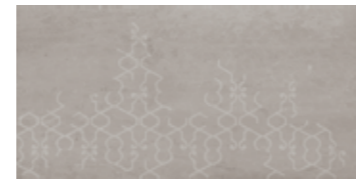

**R2AN** 30x60 Decoro B Beige

La faccia più decorata (A) è ripetibile; la faccia più vuota (B) viene usata come chiusura / The more elaborately decorated side (A) can be used recurrently; the plainer side (B) is for use as a closing element / Die dekorierte Seite (A) ist wiederholbar; die Seite mit weniger Dekor (B) wird als Abschluss verwendet / Le côté le plus décoré (A) peut être répété; le côté le plus vide (B) est utilisé comme clôture / La cara más decorada (A) es repetible; la cara más vacía (B) se usa como cierre / Более украшенная сторона (A) повторяется; более пустая сторона (B) используется в качестве затвора



**R2HS** 30x60 Muretto Beige



**R2HT** 30x60 Muretto Greige



**R2HU** 30x60 Muretto Fango



**R2HP** 30x60 Muretto Bianco



**R2HQ** 30x60 Muretto Grigio



**R2HR** 30x60 Muretto Nero

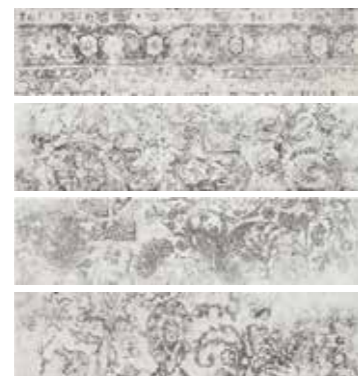

**R2AH** 15x60 Decoro Bianco



## TECH INFO

VARIAZIONI CROMATICHE / COLOUR VARIATIONS / FARBVARIATIONEN / VARIATIONS CHROMATIQUES / VARIACIONES CROMÁTICAS / ВАРИАНТЫ ОТТЕНКА



Apprezzabili differenze nell'aspetto di superficie e grafica all'interno della stessa produzione / Clearly distinguishable differences in texture and pattern within the same production run / Auffällige Unterschiede in Aussehen und Struktur innerhalb der gleichen Produktionscharge / Différences visibles au niveau de l'aspect et de la fantaisie entre les carreaux du même lot de production / Diferencias visibles en el aspecto de la superficie y los motivos dentro de un mismo lote de producción / заметные отличия вида поверхности и графики в одной и той же партии

DESTINAZIONE D'USO / INTENDED USE / ANWENDUNGSBEREICH / CHAMP D'APPLICATION / USO PREVISTO / НАЗНАЧЕНИЕ

### G (45x45 Greige, 45x45 Fango, 45x45 Nero: Naturale/Matt)

Materiali consigliati per locali sottoposti a sollecitazioni all'abrasione medio pesanti come: case individuali, commerciale leggero / Materials recommended for premises with medium-heavy abrasion levels, such as: detached homes, light-traffic commercial premises / Empfohlen für Räume mit mittelschwerer Abriebbeanspruchung wie: Einfamilienhäuser, leicht beanspruchte Gewerbebereiche / Matériaux recommandés pour des locaux soumis à des contraintes d'abrasion moyennes et fortes comme : maisons particulières, espaces commerciaux soumis à un trafic léger, etc / Materiales recomendados para locales sometidos a esfuerzos de abrasión medio-pesados, como casas unifamiliares y locales comerciales de tráfico ligero / Материалы рекомендованы для использования в частных домах и коммерческих помещениях, подверженных средне-сильному абразивному воздействию

### H (Naturale/Matt)

Materiali consigliati per sollecitazioni all'abrasione relativamente forti in ambienti anche non protetti da agenti graffianti / Materials recommended for relatively heavy abrasion levels, also in premises not protected against abrasive substances / Materials recommended for relatively heavy abrasion levels, also in premises not protected against abrasive substances / Empfohlen für starke Abriebbeanspruchungen in Bereichen auch ohne Kratzschutzbehandlung / Matériaux recommandés pour des locaux soumis à des fortes contraintes d'abrasion, même non protégés contre les agents abrasifs / Materiales recomendados para soportar esfuerzos de abrasión relativamente intensos incluso en espacios no protegidos frente a agentes abrasivos / Материалы рекомендованы для относительно сильного абразивного воздействия, в том числе в помещениях, не защищенных от царапающих элементов

CARATTERISTICHE / CHARACTERISTICS / EIGENSCHAFTEN / CARACTERISTIQUES / DATOS / ХАРАКТЕРИСТИКИ

R10	PENDULUM	BCR
{60x120, 30x120, 75x75, 60x60, 30x60, 15x60, 45x45, 30x30, 37,5x37,5}	classe 1, ptv > 36	$\mu > 0,40$
{60x120, 30x120, 75x75, 60x60, 30x60, 15x60, 45x45, 30x30, 37,5x37,5}		

≤ 175 mm<sup>2</sup>

DECORI / DECORATIVE PIECES / DEKORE / DÉCORS / DECORACIONES / ДЕКОРЫ

### Mosaico

Mosaico con pellicola trasparente removibile applicata sulla superficie anteriore / Mosaic with removable clear film applied on the front / Mosaik mit vorderseitig angebrachter durchsichtiger Abziehfolie / Mosaïque avec film transparent amovible sur la face avant / Mosaico con película transparente extraíble aplicada sobre la superficie delantera / Мозаика с прозрачной снимаемой пленкой, наносимой на переднюю поверхность

### Muretto

Mosaico assemblato su rete in fibra di vetro / Mosaic mesh - mounted on fibreglass / Auf Glasfasernetz geklebtes Mosaik / Mosaïque montée sur filet en fibre de verre / Mosaico enmallado sobre fibra de vidrio / Мозаика, собранная на сетке из стекловолокна

### Decoro 15x60

4 diversi soggetti / 4 different motifs / 4 verschiedene Motive / 4 sujets différents / 4 temas diferentes / 4 различных рисунка

PEZZI SPECIALI / TRIMS / SPEZIALTEILE / PIÈCES SPÉCIALES / PIEZAS ESPECIALES / СПЕЦИАЛЬНЫЕ ИЗДЕЛИЯ

### BT.B.C.

Battiscopa Becco Civetta ottenuto da taglio del fondo / Coved Edge Skirting Tile cut from plain tile / Sockelleiste, Halbrundstab, aus Grundfliese geschnitten / Plinthe bord rond découpée dans le fond / Rodapié canto romo conseguido mediante corte del fondo / Плинтус с закругленным краем, полученный из фоновой плитки



Battiscopa Becco Civetta ottenuto per pressatura / Press-formed Coved Edge Skirting Tile / Sockelleiste, Halbrundstab, gepresst / Plinthe bord rond obtenue par pressage / Rodapié canto romo conseguido mediante prensado / Плинтус с закругленным краем, полученный прессованием

### GR.

Gradone lineare tagliato ed assemblato / Two-piece straight step / Stufenplatte gerade geschnitten und zusammengesetzt / Large marche droite coupée et assemblée / Escalón lineal cortado y montado / Собранный загибающаяся линейная ступень со срезом

CERTIFICAZIONI / CERTIFICATIONS / ZERTIFIZIERUNGEN / CERTIFICACIONES / СЕРТИФИКАЦИИ



IMBALLI / PACKAGING / VERPACKUNGEN / EMBALLAGES / EMBALAJES / УПАКОВКИ

	scatole / box / karton / boîte / caja / короб			pallet / pallet / palette / palette / pallet / поддон				
	□	M²	KG	□	M²	KG	± mm	
60x120	2	1,44	31,47	36	51,84	1132,85	9,5	
30x120	3	1,08	22,88	48	51,84	1098,00	9,5	
75x75	2	1,12	23,81	42	47,25	1000,00	9,5	
37,5x75	4	1,12	23,81	42	47,25	1000,00	9,5	
60x60	3	1,08	22,12	40	43,20	884,88	9,5	
30x60	6	1,08	21,54	48	51,84	1034,10	9,5	
15x60	9	0,81	17,47	64	51,84	1118,20	9,5	
45x45	5	1,01	20,50	33	33,41	656,04	9	
10x10	96	1,00	14,68	66	66,02	968,73	7	
30x60	Muretto	4	0,72	17,74	27	19,44	478,88	9,5
30x60	Decoro A-B	4	0,72	12,67	-	-	-	
30x30	Mosaico	4	0,36	9,60	80	28,80	767,99	9,5
15x60	Decoro	4	0,36	7,27	-	-	-	
32,5x60	GR.	4	0,78	19,75	-	-	-	
7x75	BT.B.C.	14	10,50 ml	18,42	-	-	9,5	
7x60	BT.B.C.	15	9,0 ml	15,00	-	-	9,5	
8x45	BT.B.C.	30	13,50 ml	18,75	-	-	9	

CONCRETE EFFECT

# Studio



R4PW Tortora Rettificato 60x60 - 23<sup>5/8</sup>" x 23<sup>5/8</sup>"



## Studio

gres fine porcellanato colorato in massa - rettificato monocalibro / colorbody fine porcelain stoneware - rectified monocaliber / durchgefärbtes feinsteinzeug - rektifiziert, in einem werkmaß / grès cérame fin coloré dans la masse - rectifié monocalibre / gres porcelánico fino coloreado en toda la masa - rectificado monocalibre / гомогенный мелкозернистый керамогранит - ректифицированный монокалиберный

gruppo Bla UNI EN 14411\_G



naturale/  
matt outdoor



60x120 cm  
23<sup>5/8</sup>" x 47<sup>1/4</sup>"  
± 9,5 mm

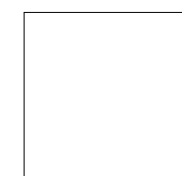

75x75 cm  
29<sup>1/2</sup>" x 29<sup>1/2</sup>"  
± 9,5 mm

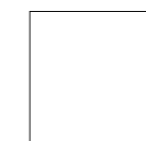

60x60 cm  
23<sup>5/8</sup>" x 23<sup>5/8</sup>"  
± 9,5 mm



30x60 cm  
11<sup>3/16</sup>" x 23<sup>5/8</sup>"  
± 9,5 mm

# Studio

60x120 - 23<sup>5/8</sup> x 47<sup>1/4</sup> 75x75 - 29<sup>1/2</sup> x 29<sup>1/2</sup> 60x60 - 23<sup>5/8</sup> x 23<sup>5/8</sup> 30x60 - 11<sup>13/16</sup> x 23<sup>5/8</sup> 30x30 - 11<sup>13/16</sup> x 11<sup>13/16</sup>

## Ghiaccio

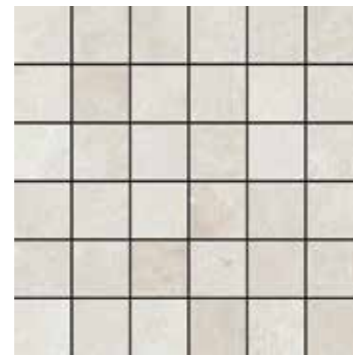

**DT0F** 7x60 BT.B.C.  
**DT05** 7x75 BT.B.C.

**R4PP** 60x120 Rett  
**R522** 75x75 Rett  
**R4PU** 60x60 Rett  
**R17V** 60x60 Rett C2  
**R14G** 60x60 Rett C3  
**R4QF** 30x60 Rett  
**R17Q** 30x60 Rett C2  
**R16S** 30x60 Rett C3

**R4QX** 30x30 Mosaico

## Grigio

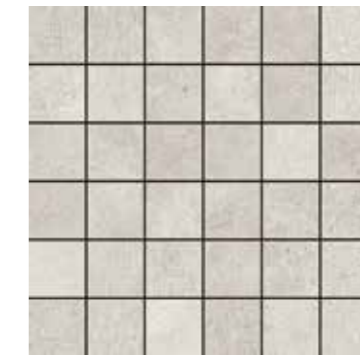

**DT0P** 7x60 BT.B.C.  
**DT0D** 7x75 BT.B.C.

**R4PS** 60x120 Rett  
**R52C** 75x75 Rett  
**R4PX** 60x60 Rett  
**R17W** 60x60 Rett C2  
**R16Q** 60x60 Rett C3  
**R4QJ** 30x60 Rett  
**R17S** 30x60 Rett C2  
**R16U** 30x60 Rett C3

**R4RA** 30x30 Mosaico

## Sabbia



**DT0G** 7x60 BT.B.C.  
**DT0A** 7x75 BT.B.C.

**R4PQ** 60x120 Rett  
**R527** 75x75 Rett  
**R4PV** 60x60 Rett  
**R17Y** 60x60 Rett C2  
**R15K** 60x60 Rett C3  
**R4QG** 30x60 Rett  
**R17R** 30x60 Rett C2  
**R16T** 30x60 Rett C3

**R4QY** 30x30 Mosaico

## Antracite



**DT0Q** 7x60 BT.B.C.  
**DT0E** 7x75 BT.B.C.

**R4PT** 60x120 Rett  
**R52D** 75x75 Rett  
**R4PY** 60x60 Rett  
**R17X** 60x60 Rett C2  
**R16R** 60x60 Rett C3  
**R4QK** 30x60 Rett  
**R17U** 30x60 Rett C2  
**R16W** 30x60 Rett C3

**R4RC** 30x30 Mosaico

## Tortora



**DT0K** 7x60 BT.B.C.  
**DT0C** 7x75 BT.B.C.

**R4PR** 60x120 Rett  
**R52A** 75x75 Rett  
**R4PW** 60x60 Rett  
**R17Z** 60x60 Rett C2  
**R16P** 60x60 Rett C3  
**R4QH** 30x60 Rett  
**R17T** 30x60 Rett C2  
**R16V** 30x60 Rett C3

**R4QZ** 30x30 Mosaico

Decors

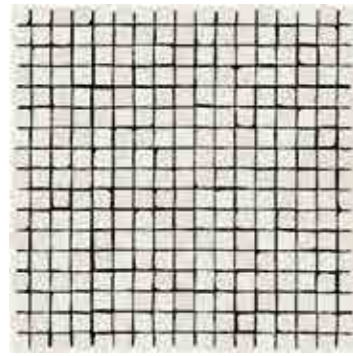

R4QR 30x30 Mosaico Ghiaccio

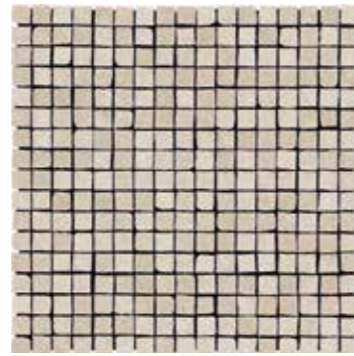

R4QS 30x30 Mosaico Sabbia



R4QT 30x30 Mosaico Tortora

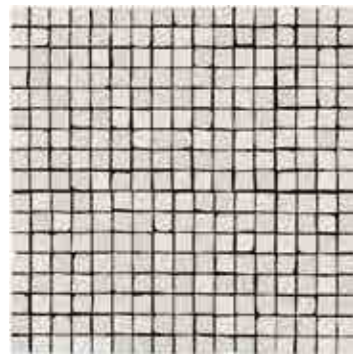

R4QU 30x30 Mosaico Grigio

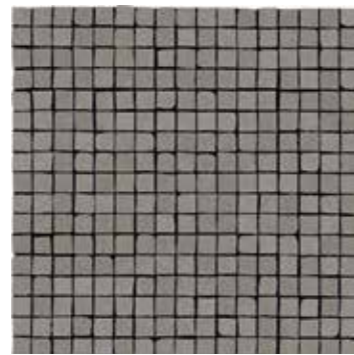

R4QV 30x30 Mosaico Antracite



R4RD 60x60 Decoro Cementine



Abbinabile ai colori / Matching with colours / Mit den Grundfliesen kombinierbar / Peut s'associer aux carreaux de base de couleurs / Puede combinarse con los fondos / Сочетается с фоновой плиткой



Ghiaccio Sabbia Tortora Grigio Antracite

TECH INFO

VARIAZIONI CROMATICHE / COLOUR VARIATIONS / FARBVARIATIONEN / VARIATIONS CHROMATIQUES / VARIACIONES CROMÁTICAS / ВАРИАНТЫ ОТТЕКHA



Apprezzabili differenze nell'aspetto di superficie e grafica all'interno della stessa produzione / Clearly distinguishable differences in texture and pattern within the same production run / Auffällige Unterschiede in Aussehen und Struktur innerhalb der gleichen Produktionscharge / Différences visibles au niveau de l'aspect et de la fantaisie entre les carreaux du même lot de production / Diferencias visibles en el aspecto de la superficie y los motivos dentro de un mismo lote de producción / заметные отличия вида поверхности и графики в одной и той же партии

DESTINAZIONE D'USO / INTENDED USE / ANWENDUNGSBEREICH / CHAMP D'APPLICATION / USO PREVISTO / НАЗНАЧЕНИЕ

H (Naturale/Matt, Strutturato)

Materiali consigliati per sollecitazioni all'abrasione relativamente forti in ambienti anche non protetti da agenti graffianti / Materials recommended for relatively heavy abrasion levels, also in premises not protected against abrasive substances / Materials recommended for relatively heavy abrasion levels, also in premises not protected against abrasive substances / Empfohlen für starke Abriebbeanspruchungen in Bereichen auch ohne Kratzschutzbehandlung / Matériaux recommandés pour des locaux soumis à des fortes contraintes d'abrasion, même non protégés contre les agents abrasifs / Materiales recomendados para soportar esfuerzos de abrasión relativamente intensos incluso en espacios no protegidos frente a agentes abrasivos / Материалы рекомендованы для относительно сильного абразивного воздействия, в том числе в помещениях, не защищенных от царапающих элементов

CLASSIFICAZIONE / CLASSIFICATION / KLASSIFIZIERUNG / CLASSIFICATION / CLASIFICACIÓN / КЛАССИФИКАЦИЯ

C2

Classificazione in base alla normativa spagnola UNE - ENV 12633:2003 / Classification according to Spanish standard UNE - ENV 12633: 2003 / Klassifizierung gemäß der spanischen Norm UNE - ENV 12633:2003 / Classification selon la norme espagnole UNE-ENV 12633:2003 / Clasificación con arreglo a la norma española UNE - ENV 12633:2003 / Классификация в соответствии с испанским стандартом UNE - ENV 12633:2003

C3

Classificazione in base alla normativa spagnola UNE - ENV 12633:2003 / Classification according to Spanish standard UNE - ENV 12633: 2003 / Klassifizierung gemäß der spanischen Norm UNE - ENV 12633:2003 / Classification selon la norme espagnole UNE-ENV 12633:2003 / Clasificación con arreglo a la norma española UNE - ENV 12633:2003 / Классификация в соответствии с испанским стандартом UNE - ENV 12633:2003

DECORI / DECORATIVE PIECES / DEKORE / DÉCORS / DECORACIONES / ДЕКОРЫ

Mosaico

Mosaico assemblato su rete in fibra di vetro / Mosaic mesh - mounted on fibreglass / Auf Glasfasernetz geklebtes Mosaik / Mosaïque montée sur filet en fibre de verre / Mosaico enmallado sobre fibra de vidrio / Мозаика, собранная на сетке из стекловолокна

PEZZI SPECIALI / TRIMS / SPEZIALTEILE / PIÈCES SPÉCIALES / PIEZAS ESPECIALES / СПЕЦИАЛЬНЫЕ ИЗДЕЛИЯ

BT.B.C.

Battiscopa Becco Civetta ottenuto da taglio del fondo / Coved Edge Skirting Tile cut from plain tile / Sockelleiste, Halbrundstab, aus Grundfliese geschnitten / Plinthe bord rond découpée dans le fond / Rodapié canto romo conseguido mediante corte del fondo / Плинтус с закругленным краем, полученный из фоновой плитки

CARATTERISTICHE / CHARACTERISTICS / EIGENSCHAFTEN / CARACTERISTIQUES / DATOS / ХАРАКТЕРИСТИКИ

	R9	PENDULUM classe 1 classe 2 C2 classe 3 C3 ptv > 36 C2, C3	D-COF > 0,42	BCR μ > 0,40
	R10 C2			
	R11 C3			
	B C3			
	≤ 175 mm <sup>2</sup>			

CERTIFICAZIONI / CERTIFICATIONS / ZERTIFIZIERUNGEN / CERTIFICATIONS / CERTIFICACIONES / СЕРТИФИКАЦИИ



IMBALLI / PACKAGING / VERPACKUNGEN / EMBALLAGES / EMBALAJES / УПАКОВКИ

	scatole / box / karton / boîte / caja / коробк			pallet / pallet / palette / palette / pallet / поддон			
	□	M <sup>2</sup>	KG	□	M <sup>2</sup>	KG	± mm
60x120	2	1,44	31,47	36	51,84	1132,85	9,5
75x75	2	1,13	23,81	42	47,25	1000,00	9,5
60x60	3	1,08	21,01	40	43,20	840,50	9,5
60x60	3	1,08	21,01	40	43,20	840,50	9,5
30x60	6	1,08	21,07	48	51,84	1011,41	9,5
30x60	6	1,08	21,07	48	51,84	1011,41	9,5
60x60	3	1,08	21,88	40	43,20	875,14	9,5
30x30	4	0,36	7,51	80	28,80	600,66	9,5
7x75	14	10,50 ml	18,87	-	-	-	9,5
7x60	15	9,00 ml	17,47	-	-	-	9,5

CONCRETE EFFECT

# Epoca



R54X Cotto Scuro Rettificato 30x30 - 11<sup>13/16</sup> x 11<sup>13/16</sup> - R044 Cotto Scuro Gradone 30x33 - 11<sup>13/16</sup> x 12<sup>15/16</sup>

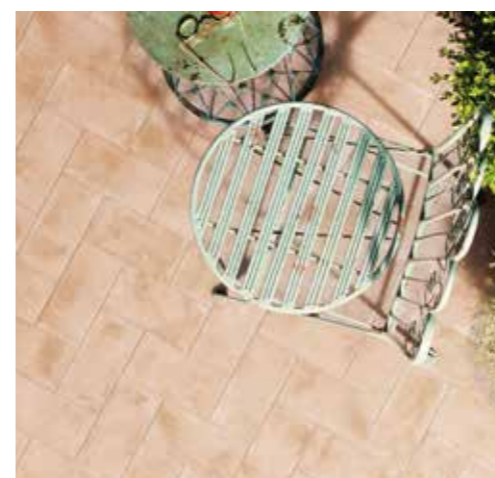

## Epoca

gres porcellanato / porcelain stoneware / feinsteinzeug / grès cérame émaillé / gres porcelánico / керамогранит  
gruppo Bla UNI EN 14411\_6



naturale/  
matt outdoor



30x30 cm  
11<sup>13/16</sup> x 11<sup>13/16</sup>  
± 9 mm



15x30 cm  
5<sup>7/8</sup> x 11<sup>13/16</sup>  
± 9 mm



15x15 cm  
5<sup>7/8</sup> x 5<sup>7/8</sup>  
± 9 mm

# Epoca

30x30 - 11<sup>13/16</sup>"x11<sup>13/16</sup>" 15x30 - 5<sup>7/8</sup>"x11<sup>13/16</sup>" 15x15 - 5<sup>7/8</sup>"x5<sup>7/8</sup>" 13,8x30 - 5<sup>7/16</sup>"x11<sup>13/16</sup>" 13,8x13,8 - 5<sup>7/16</sup>"x5<sup>7/16</sup>" 6,9x6,9 - 2<sup>11/16</sup>"x2<sup>11/16</sup>"

## Ocra



R54V 30x30 Rett  
R54Z 15x30 Rett  
R55E 15x30 Strutt  
R558 15x15 Rett

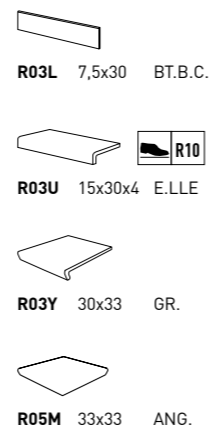

## Cotto Rosso



R54Y 30x30 Rett  
R557 15x30 Rett  
R55H 15x30 Strutt  
R55D 15x15 Rett

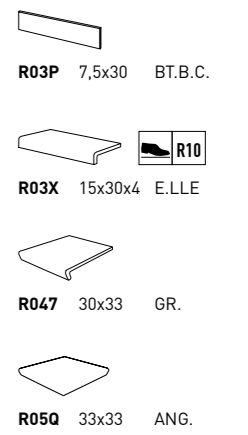

## Rosa



R54W 30x30 Rett  
R551 15x30 Rett  
R55F 15x30 Strutt  
R55A 15x15 Rett

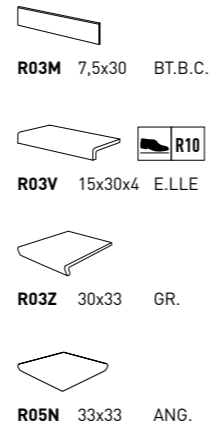

## Decors



R03Q 30x30 Decoro Tappeto Ocra



R03S 13,8x13,8 AN. Ocra



R03R 13,8x30 F. Ocra



R03T 6,9x6,9 Decoro Cabochon Ocra

## Cotto Scuro



R54X 30x30 Rett  
R553 15x30 Rett  
R55G 15x30 Strutt  
R55C 15x15 Rett

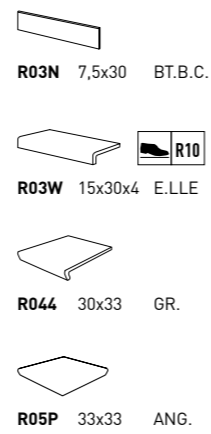



R55F Rosa Strutturato 15x30 - 5<sup>7/8</sup> x 11<sup>13/16</sup>"

**TECH INFO**

VARIAZIONI CROMATICHE / COLOUR VARIATIONS / FARBVARIATIONEN / VARIATIONS CHROMATIQUES / VARIACIONES CROMÁTICAS / ВАРИАНТЫ ОТТЕНКА



Significativa variazione di aspetto superficiale, grafica e colore da piastrella a piastrella e all'interno della stessa piastrella. Si consiglia di visionare la gamma cromatica prima della selezione del materiale / Significant variation in texture, pattern and colour from tile to tile within the same production run. The colour range should be viewed before selecting the material / Bedeutende Variation in Aussehen, Struktur und Farbe von Fliese zu Fliese und in ein und derselben Fliese. Es wird empfohlen, das Farbsortiment vor der Auswahl des Materials zu prüfen / Variation significative au niveau de l'aspect, de la fantaisie et de la couleur entre les carreaux et au sein d'un même carreau. Il est recommandé de consulter la gamme des couleurs avant de sélectionner le matériel / Variación considerable en el aspecto superficial, los motivos y el color entre un azulejo y otro y dentro del propio azulejo. Es aconsejable visualizar la gama cromática antes de seleccionar el material / Значительные отличия вида поверхности, графики и цвета у разных плиток и на одной и той же плитке. Перед отбором материала рекомендуется посмотреть цветовую гамму

DESTINAZIONE D'USO / INTENDED USE / ANWENDUNGSBEREICH / CHAMP D'APPLICATION / USO PREVISTO / НАЗНАЧЕНИЕ

**F (Decoro Tappeto Ocra, F. Ocra, AN. Ocra, Decoro Cabochoh Ocra: Naturale/Matt)**

Materiali consigliati per qualsiasi locale di un'abitazione che non abbia collegamenti diretti con l'esterno o accessi non protetti da zerbini. Medie sollecitazioni all'abrasione / Tiles suitable for any room of a house without direct access from the outside or access not protected by doormats. Mean stress abrasive wear / Für alle Räume des Wohnbereichs empfohlen, zu denen man keinen direkten Zutritt von außen hat oder welche nicht durch Fußteppiche abgegrenzt sind. Mittlere Abriebbeanspruchung / Matériaux conseillés pour toutes les pièces d'une maison qui n'a pas d'accès directs par l'extérieur ou non protégés par des paillassons. Abrasion sous contraintes moyennes / Materiales aconsejados para cualquier habitación de una vivienda sin accesos directos desde el exterior o accesos no protegidos por felpudos. Esfuerzos medianos por abrasión / Материалы рекомендованы для любых жилых помещений, не имеющих прямого выхода на улицу или же доступа без входных ковриков. Среднее абразивное воздействие

**G (Naturale/Matt, Strutturato)**

Materiali consigliati per locali sottoposti a sollecitazioni all'abrasione medio pesanti come: case individuali, commerciale leggero / Materials recommended for premises with medium-heavy abrasion levels, such as: detached homes, light-traffic commercial premises / Empfohlen für Räume mit mittelschwerer Abriebbeanspruchung wie: Einfamilienhäuser, leicht beanspruchte Gewerbebereiche / Matériaux recommandés pour des locaux soumis à des contraintes d'abrasion moyennes et fortes comme : maisons particulières, espaces commerciaux soumis à un trafic léger, etc / Materiales recomendados para locales sometidos a esfuerzos de abrasión medio-pesados, como casas unifamiliares y locales comerciales de tráfico ligero / Материалы рекомендованы для использования в частных домах и коммерческих помещениях, подверженных средне-сильному абразивному воздействию

CARATTERISTICHE / CHARACTERISTICS / EIGENSCHAFTEN / CARACTERISTIQUES / DATOS / ХАРАКТЕРИСТИКИ

	<b>R9</b> <b>R10</b> Strutturato	<b>PENDULUM</b> <b>classe 1</b> Naturale/Matt <b>classe 2</b> Strutturato <b>ptv &gt; 36</b> Strutturato	<b>D-COF</b> <b>&gt; 0,42</b>	<b>BCR</b> <b>μ &gt; 0,40</b>
	<b>B</b> Strutturato			
	<b>≤ 175 mm²</b>			

PEZZI SPECIALI / TRIMS / SPEZIALTEILE / PIÈCES SPÉCIALES / PIEZAS ESPECIALES / СПЕЦИАЛЬНЫЕ ИЗДЕЛИЯ

**BT.B.C.**

Battiscopa Becco Civetta ottenuto per pressatura / Press-formed Coved Edge Skirting Tile / Sockelleiste, Halbrundstab, gepresst / Plinthe bord rond obtenue par pressage / Rodapié canto romo conseguido mediante prensado / Плинтус с закругленным краем, полученный прессованием

**E.Elle**

Elemento ad Elle monolitico piegato / One-piece bent L-tile / Schenkelplatte einteilig, gebogen / Élément en L monolithique cintré / Elemento en forma de "L" monolitico doblado / Монолитный гнутый г-образный элемент

**GR.**

Gradone monolitico piegato / One-piece bent step-tread tile / Stufen einteilig, gebogen / Nez de marche monolithique cintré / Peldaño ingletado monolitico doblado / Линейная монолитная ступень

**ANG.**

Angolare monolitico piegato / One-piece bent corner tile / Eckstück, einteilig, gebogen / Pièce d'angle monolithique cintré / Pieza angular monolítica doblada / монолитный угол

CONSIGLI DI POSA / INSTALLATION ADVICE / HINWEISE ZUR VERLEGUNG / CONSEILS DE POSE / SUGERENCIAS PARA LA COLOCACIÓN / РЕКОМЕНДАЦИИ ПО УКЛАДКЕ

Per le pavimentazioni esterne non protette, Ragno consiglia di creare una pendenza ≥ 1,5% sulla superficie calpestabile allo scopo di limitare il formarsi di ristagni d'acqua localizzati. Nel caso in cui questi ristagni permangano sulla superficie delle piastrelle nonostante una posa a regola d'arte, è necessario intervenire meccanicamente con l'utilizzo di scope o aspira-liquidi / For unprotected outdoor pavings, Ragno recommends the creation of a gradient of ≥ 1.5% on the finished surface, to prevent the formation of patches of standing water. In the event that standing water persists on the surface of the tiles in spite of correct installation, it must be removed mechanically with the aid of brooms or wet-and-dry vacuum cleaners / Zur Unterbindung von punktueller Stauwasserbildung bei Belägen in ungeschützten Außenbereichen, empfiehlt die Ragno die Ausbildung eines Gefälles ≥ 1,5% auf der Trittlfläche. Sollte trotz fachgerechter Verlegung Stauwasser auf der Fliesenoberfläche zurückbleiben, ist dessen mechanische Entfernung mit Hilfe eines Besens oder Nasssaugers erforderlich / Pour des sols extérieurs non protégés, Ragno conseille de créer une inclinaison ≥ 1,5% sur la surface de piétinement en vue de limiter la stagnation localisée de l'eau. Si, malgré une pose dans les règles de l'art, cette stagnation devait persister à la surface des carreaux, une intervention mécanique, au moyen de balais et d'aspirateurs de liquides, est alors nécessaire / En el caso de pavimentaciones exteriores no protegidas, Ragno recomienda crear una pendiente ≥ 1,5% en la superficie transitable para limitar la formación de depósitos localizados de agua estancada. En caso de que estos depósitos de agua permanezcan en la superficie del azulejo, aun cuando la colocación se haya realizado correctamente, será necesario intervenir mecánicamente empleando un cepillo o un aspirador de líquidos / Для наружных незащищенных полов Ragno рекомендует создавать уклон ≥ 1,5% на пешеходной поверхности для снижения образования локальных застоев воды. В случае, если застои воды образуются на плитке несмотря на правильную укладку, необходимо прибегать к использованию механических средств, таких как щетки или же аппараты для сбора жидкостей

CERTIFICAZIONI / CERTIFICATIONS / ZERTIFIZIERUNGEN / CERTIFICATIONS / CERTIFICACIONES / СЕРТИФИКАЦИИ



IMBALLI / PACKAGING / VERPACKUNGEN / EMBALLAGES / EMBALAJES / УПАКОВКИ

	scatole / box / karton / boîte / caja / коробк			pallet / pallet / palette / palette / pallet / поддон			
	□	M²	KG	□	M²	KG	± mm
30x30	14	1,26	23,56	40	50,40	942,58	9
15x30	20	0,90	16,83	64	57,60	1077,24	9
15x15	40	0,90	16,83	64	57,60	1077,24	9
6,9x6,9	8	0,04	64,17	-	-	-	-
7,5x30	BT.B.C.	50	15,00 ml	19,79	-	-	8
15x30x4	E. ELLE	6	0,27	6,87	-	-	9,5
30x33	GR.	6	0,60	175,71	-	-	9,5
33x33	ANG.	2	0,22	7,43	-	-	-



CONCRETE EFFECT

# Calce



## Calce

gres porcellanato / porcelain stoneware / feinsteinzeug / grès cérame émaillé / gres porcelánico / керамогранит

gruppo Bla UNI EN 14411\_6



naturale/  
matt



7x28 cm

2<sup>3</sup>/<sub>4</sub> x 11<sup>1</sup>/<sub>8</sub>"

± 9 mm

R02S Calce Perla 7x28 - 2<sup>3</sup>/<sub>4</sub> x 11<sup>1</sup>/<sub>8</sub>" - R04N Realstone\_Quarzite Bianco Rettificato 60x60 - 23<sup>5</sup>/<sub>8</sub> x 23<sup>5</sup>/<sub>8</sub>"

# Calce

7x28 - 2<sup>3/4</sup>"x11<sup>1/8</sup>"

## Puro



R02Q 7x28

## Panna



R02R 7x28

## Perla



R02S 7x28

## Nocciola



R02T 7x28

## Antracite



R02U 7x28

## Nero



R02V 7x28

## TECH INFO

DESTINAZIONE D'USO / INTENDED USE / ANWENDUNGSBEREICH / CHAMP D'APPLICATION / USO PREVISTO / НАЗНАЧЕНИЕ

### F (Nero: Naturale/Matt)

Materiali consigliati per qualsiasi locale di un'abitazione che non abbia collegamenti diretti con l'esterno o accessi non protetti da zerbini. Medie sollecitazioni all'abrasione / Tiles suitable for any room of a house without direct access from the outside or access not protected by doormats. Mean stress abrasive wear / Für alle Räume des Wohnbereichs empfohlen, zu denen man keinen direkten Zutritt von außen hat oder welche nicht durch Fußteppiche abgegrenzt sind. Mittlere Abriebbeanspruchung / Matériaux conseillés pour toutes les pièces d'une maison qui n'a pas d'accès directs par l'extérieur ou non protégés par des paillasons. Abrasion sous contraintes moyennes / Materiales aconsejados para cualquier habitación de una vivienda sin accesos directos desde el exterior o accesos no protegidos por felpudos. Esfuerzos medianos por abrasión / Материалы рекомендованы для любых жилых помещений, не имеющих прямого выхода на улицу или же доступа без входных ковриков. Среднее абразивное воздействие

### G (Puro, Panna, Perla, Nocciola, Antracite: Naturale/Matt)

Materiali consigliati per locali sottoposti a sollecitazioni all'abrasione medio pesanti come: case individuali, commerciale leggero / Materials recommended for premises with medium-heavy abrasion levels, such as: detached homes, light-traffic commercial premises / Empfohlen für Räume mit mittelschwerer Abriebbeanspruchung wie: Einfamilienhäuser, leicht beanspruchte Gewerbebereiche / Matériaux recommandés pour des locaux soumis à des contraintes d'abrasion moyennes et fortes comme : maisons particulières, espaces commerciaux soumis à un trafic léger, etc / Materiales recomendados para locales sometidos a esfuerzos de abrasión medio-pesados, como casas unifamiliares y locales comerciales de tráfico ligero / Материалы рекомендованы для использования в частных домах и коммерческих помещениях, подверженных средне-сильному абразивному воздействию

CARATTERISTICHE / CHARACTERISTICS / EIGENSCHAFTEN / CARACTERISTIQUES / DATOS / ХАРАКТЕРИСТИКИ

R10	PENDULUM classe 1 ptv > 36	D-COF > 0,42	BCR μ > 0,40
A			
≤ 175 mm <sup>2</sup>			

CERTIFICAZIONI / CERTIFICATIONS / ZERTIFIZIERUNGEN / CERTIFICACIONES / СЕРТИФИКАЦИИ



IMBALLI / PACKAGING / VERPACKUNGEN / EMBALAJES / УПАКОВКИ

	scatole / box / karton / boîte / caja / короб			pallet / pallet / palette / palette / pallet / поддон			
	□	M <sup>2</sup>	KG	□	M <sup>2</sup>	KG	± mm
7x28	50	0,98	18,72	52	50,96	973,61	9

CONCRETE EFFECT

# Eden



## Eden

gres porcellanato / porcelain stoneware / feinsteinzeug / grès cérame émaillé / gres porcelánico / керамогранит  
Gruppo BIa UNI EN 14411\_G

7x28 Eden Decoro Tin  
rivestimenti in pasta bianca / white body wall tiles / wandfliesen aus weissen ton scherben / revêtements en pate blanche / revestimientos en pasta blanca / облицовка из белой глины  
Gruppo BIlll UNI EN 14411\_L



  
21x18,2 cm  
8<sup>1/4</sup>" x 7<sup>3/16</sup>"  
± 9,5 mm

  
7x28 cm  
2<sup>3/4</sup>" x 11<sup>1/16</sup>"  
± 9 mm

RGL0 Eden Esagona Fango 21x18,2 - 8<sup>1/4</sup>" x 7<sup>3/16</sup>" - R17M Woodchoice Chevron Salt 11x54 - 4<sup>5/8</sup>" x 21<sup>1/4</sup>"

# Eden

21x18,2 - 8<sup>1/4</sup> x 7<sup>3/16</sup> 7x28 - 2<sup>3/4</sup> x 11<sup>1/8</sup>

## Bianco



**RGKX** 21x18,2 Esagona



**R06H** 7x28

## Cotone



**RGKY** 21x18,2 Esagona



**R06J** 7x28

## Decors



**R12C** 7x28 Decoro Tin Bianco



**R12D** 7x28 Decoro Tin Cotone

## Greige



**RGKZ** 21x18,2 Esagona



**R06K** 7x28

## Fango



**RGL0** 21x18,2 Esagona



**R06L** 7x28

## Ottanio



**RGL1** 21x18,2 Esagona



**R06M** 7x28



**Cotone**



**RF8N** 21x18,2 Decoro Tappeto 1 Bianco



**RF8P** 21x18,2 Decoro Tappeto 1 Cotone



**RF8Q** 21x18,2 Decoro Tappeto 2 Bianco



**RF8R** 21x18,2 Decoro Tappeto 2 Cotone



**RGL2** 21x18,2 Esagona Decoro Romance Bianco



**RGL3** 21x18,2 Esagona Decoro Romance Cotone



RGL2 Eden Esagona Decoro Romance Bianco 21x18,2 - 8<sup>1/4</sup> x 7<sup>3/16</sup> - R85W Patina Petrolio Rettificato - 75x75 29<sup>1/2</sup> x 29<sup>1/2</sup>

TECH INFO

VARIAZIONI CROMATICHE / COLOUR VARIATIONS / FARBVARIATIONEN / VARIATIONS CHROMATIQUES / VARIACIONES CROMÁTICAS / ВАРИАНТЫ ОТТЕЧКА

V2 (Greige, Fango, Ottanio)

Apprezzabili differenze nell'aspetto di superficie e grafica all'interno della stessa produzione / Clearly distinguishable differences in texture and pattern within the same production run / Auffällige Unterschiede in Aussehen und Struktur innerhalb der gleichen Produktionscharge / Différences visibles au niveau de l'aspect et de la fantaisie entre les carreaux du même lot de production / Diferencias visibles en el aspecto de la superficie y los motivos dentro de un mismo lote de producción / заметные отличия вида поверхности и графики в одной и той же партии

V3 (Cotone)

Significativa variazione di aspetto superficiale, grafica e colore da piastrella a piastrella e all'interno della stessa piastrella. Si consiglia di visionare la gamma cromatica prima della selezione del materiale / Significant variation in texture, pattern and colour from tile to tile within the same production run. The colour range should be viewed before selecting the material / Bedeutende Variation in Aussehen, Struktur und Farbe von Fliese zu Fliese und in ein und derselben Fliese. Es wird empfohlen, das Farbsortiment vor der Auswahl des Materials zu prüfen / Variation significative au niveau de l'aspect, de la fantaisie et de la couleur entre les carreaux et au sein d'un même carreau. Il est recommandé de consulter la gamme des couleurs avant de sélectionner le matériel / Variación considerable en el aspecto superficial, los motivos y el color entre un azulejo y otro y dentro del propio azulejo. Es aconsejable visualizar la gama cromática antes de seleccionar el material / Значительные отличия вида поверхности, графики и цвета у разных плиток и на одной и той же плитке. Перед отбором материала рекомендуется посмотреть цветовую гамму

DESTINAZIONE D'USO / INTENDED USE / ANWENDUNGSBEREICH / CHAMP D'APPLICATION / USO PREVISTO / НАЗНАЧЕНИЕ

F (Semi-Matt)

Materiali consigliati per qualsiasi locale di un'abitazione che non abbia collegamenti diretti con l'esterno o accessi non protetti da zerbini. Medie sollecitazioni all'abrasione / Tiles suitable for any room of a house without direct access from the outside or access not protected by doormats. Mean stress abrasive wear / Für alle Räume des Wohnbereichs empfohlen, zu denen man keinen direkten Zutritt von außen hat oder welche nicht durch Fußteppiche abgegrenzt sind. Mittlere Abriebbeanspruchung / Matériaux conseillés pour toutes les pièces d'une maison qui n'a pas d'accès directs par l'extérieur ou non protégés par des paillassons. Abrasion sous contraintes moyennes / Materiales aconsejados para cualquier habitación de una vivienda sin accesos directos desde el exterior o accesos no protegidos por felpudos. Esfuerzos medianos por abrasión / Материалы рекомендованы для любых жилых помещений, не имеющих прямого выхода на улицу или же доступа без входных ковриков. Среднее абразивное воздействие

G (Decoro Tappeto 1-2, Esagona Decoro Romance: Semi-Matt)

Materiali consigliati per locali sottoposti a sollecitazioni all'abrasione medio pesanti come: case individuali, commerciale leggero / Materials recommended for premises with medium-heavy abrasion levels, such as: detached homes, light-traffic commercial premises / Empfohlen für Räume mit mittelschwerer Abriebbeanspruchung wie: Einfamilienhäuser, leicht beanspruchte Gewerbebereiche / Matériaux recommandés pour des locaux soumis à des contraintes d'abrasion moyennes et fortes comme : maisons particulières, espaces commerciaux soumis à un trafic léger, etc / Materiales recomendados para locales sometidos a esfuerzos de abrasión medio-pesados, como casas unifamiliares y locales comerciales de tráfico ligero / Материалы рекомендованы для использования в частных домах и коммерческих помещениях, подверженных средне-сильному абразивному воздействию

DECORI / DECORATIVE PIECES / DEKORE / DÉCORS / DECORACIONES / ДЕКОРЫ

Esagona Decoro Romance

12 diversi soggetti / 12 different motifs / 12 verschiedene Motive / 12 sujets différents / 12 temas diferentes / 12 различных рисунка

CERTIFICAZIONI / CERTIFICATIONS / ZERTIFIZIERUNGEN / CERTIFICACIONES / СЕРТИФИКАЦИИ



IMBALLI / PACKAGING / VERPACKUNGEN / EMBALLAGES / EMBALAJES / УПАКОВКИ

		scatole / box / karton / boîte / caja / коробки			pallet / pallet / palette / palette / pallet / поддон			
		□	M²	KG	□	M²	KG	± mm
21x18,2		16	0,46	9,64	100	45,86	963,88	9,5
7x28		50	0,98	19,42	52	50,96	1009,77	9
21x18,2	Decoro	16	0,46	9,64	100	45,86	963,88	9,5
7x28	Decoro Tin	8	0,16	8,17	-	-	-	-

# WOOD EFFECT



282	Woodsense
286	Woodliving
292	Woodtale
298	Woodmania
304	Woodsoft
310	Woodplace
316	Woodclassic
322	Woodreal
328	Woodshape
332	Woodstory
338	Harmony
344	Woodcomfort
350	Woodlike
354	Woodclass
360	Woodpassion
366	Woodcraft
372	Woodessence
378	Woodglam
382	Woodchoice

WOOD EFFECT

# Woodsense



R7FR Marrone Rettificato 19x150 - 7<sup>1/2</sup> x 59<sup>1/8</sup>"



## Woodsense

gres fine porcellanato colorato in massa - rettificato monocalibro / colorbody fine porcelain stoneware - rectified monocaliber / durchgefärbtes feinsteinzeug - rektifiziert, in einem werkmaß / grès cérame fin coloré dans la masse - rectifié monocalibre / gres porcelánico fino coloreado en toda la masa - rectificado monocalibre / гомогенный мелкозернистый керамогранит - ректифицированный монокалиберный

gruppo Bla UNI EN 14411\_G



naturale/  
matt outdoor



25x150 cm  
9<sup>13/16</sup>" x 59<sup>1/8</sup>"  
± 9,5 mm

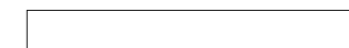

19x150 cm  
7<sup>1/2</sup>" x 59<sup>1/8</sup>"  
± 9,5 mm



20x120 cm  
7<sup>7/8</sup>" x 47<sup>1/8</sup>"  
± 9,5 mm

XT20  
Woodsense XT20  
> p.438

# Woodsense

25x150 - 9<sup>13</sup>/<sub>16</sub>" x 59<sup>15</sup>/<sub>16</sub>" 19x150 - 7<sup>12</sup>/<sub>16</sub>" x 59<sup>15</sup>/<sub>16</sub>" 20x120 - 7<sup>15</sup>/<sub>16</sub>" x 47<sup>14</sup>/<sub>16</sub>"

## Avorio



**R7EV** 25x150 Rett  
**R7FN** 19x150 Rett  
**R7FU** 20x120 Rett  
**R7G0** 20x120 Grip Rett



**R8CH** 6x60 BT.B.C.  
**R8CU** 6x75 BT.B.C.

## Beige



**R7EW** 25x150 Rett  
**R7FQ** 19x150 Rett  
**R7FV** 20x120 Rett  
**R7GA** 20x120 Grip Rett



**R8CK** 6x60 BT.B.C.  
**R8CV** 6x75 BT.B.C.

## Marrone



**R7EX** 25x150 Rett  
**R7FR** 19x150 Rett  
**R7FW** 20x120 Rett  
**R7GC** 20x120 Grip Rett



**R8CL** 6x60 BT.B.C.  
**R8CW** 6x75 BT.B.C.

## Grigio



**R7EY** 25x150 Rett  
**R7FS** 19x150 Rett  
**R7FX** 20x120 Rett  
**R7GD** 20x120 Grip Rett



**R8CM** 6x60 BT.B.C.  
**R8CX** 6x75 BT.B.C.

## TECH INFO

VARIAZIONI CROMATICHE / COLOUR VARIATIONS / FARBVARIATIONEN / VARIATIONS CHROMATIQUES / VARIACIONES CROMÁTICAS / ВАРИАНТЫ ОТТЕНКА



Significativa variazione di aspetto superficiale, grafica e colore da piastrella a piastrella e all'interno della stessa piastrella. Si consiglia di visionare la gamma cromatica prima della selezione del materiale / Significant variation in texture, pattern and colour from tile to tile within the same production run. The colour range should be viewed before selecting the material / Bedeutende Variation in Aussehen, Struktur und Farbe von Fliese zu Fliese und in ein und derselben Fliese. Es wird empfohlen, das Farbsortiment vor der Auswahl des Materials zu prüfen / Variation significative au niveau de l'aspect, de la fantaisie et de la couleur entre les carreaux et au sein d'un même carreau. Il est recommandé de consulter la gamme des couleurs avant de sélectionner le matériel / Variación considerable en el aspecto superficial, los motivos y el color entre un azulejo y otro y dentro del propio azulejo. Es aconsejable visualizar la gama cromática antes de seleccionar el material. / Значительные отличия вида поверхности, графики и цвета у разных плиток и на одной и той же плитке. Перед отбором материала рекомендуется посмотреть цветовую гамму

DESTINAZIONE D'USO / INTENDED USE / ANWENDUNGSBEREICH / CHAMP D'APPLICATION / USO PREVISTO / НАЗНАЧЕНИЕ

### G (Naturale/Matt, Grip)



Materiali consigliati per locali sottoposti a sollecitazioni all'abrasione medio pesanti come: case individuali, commerciale leggero / Materials recommended for premises with medium-heavy abrasion levels, such as: detached homes, light-traffic commercial premises / Empfohlen für Räume mit mittelschwerer Abriebbeanspruchung wie: Einfamilienhäuser, leicht beanspruchte Gewerbebereiche / Matériaux recommandés pour des locaux soumis à des contraintes d'abrasion moyennes et fortes comme : maisons particulières, espaces commerciaux soumis à un trafic léger, etc / Materiales recomendados para locales sometidos a esfuerzos de abrasión medio-pesados, como casas unifamiliares y locales comerciales de tráfico ligero / Материалы рекомендованы для использования в частных домах и коммерческих помещениях, подверженных средне-сильному абразивному воздействию

PEZZI SPECIALI / TRIMS / SPEZIALTEILE / PIÈCES SPÉCIALES / PIEZAS ESPECIALES / СПЕЦИАЛЬНЫЕ ИЗДЕЛИЯ

### BT.B.C.

Battiscopa Becco Civetta ottenuto da taglio del fondo / Coved Edge Skirting Tile cut from plain tile / Sockelleiste, Halbrundstab, aus Grundfliese geschnitten / Plinthe bord rond découpée dans le fond / Rodapié canto romo conseguido mediante corte del fondo / Плинтус с закругленным краем, полученный из фоновой плитки

CARATTERISTICHE / CHARACTERISTICS / EIGENSCHAFTEN / CARACTERISTIQUES / DATOS / ХАРАКТЕРИСТИКИ

	<b>R10</b> Naturale/Matt <b>R11</b> Grip	<b>PENDULUM</b> classe 1 Naturale/Matt classe 3 Grip ptv > 36 Grip	<b>D-COF</b> > 0,42	<b>BCR</b> μ > 0,40
	<b>B</b> Grip			
	≤ 175 mm <sup>2</sup>			

CERTIFICAZIONI / CERTIFICATIONS / ZERTIFIZIERUNGEN / CERTIFICACIONES / СЕРТИФИКАЦИИ



IMBALLI / PACKAGING / VERPACKUNGEN / EMBALLAGES / EMBALAJES / УПАКОВКИ

		scatole / box / karton / boîte / caja / коробк			pallet / pallet / palette / palette / pallet / поддон			
		□	M <sup>2</sup>	KG	□	M <sup>2</sup>	KG	± mm
25x150	Rettificato	3	1,13	24,90	45	50,63	1120,40	9,5
19x150	Rettificato	4	1,14	24,75	48	54,72	1188,00	9,5
20x120	Rettificato	3	0,72	15,57	60	43,20	934,00	9,5
6x60	BT.B.C.	13	7,80 ml	15,00	-	-	-	9,5
6x75	BT.B.C.	13	9,75 ml	20,00	-	-	-	9,5



WOOD EFFECT

# Woodliving



R3ZY Rovere Scuro 30x120 - 11<sup>13</sup>/<sub>16</sub>"x47<sup>1</sup>/<sub>4</sub>"



## Woodliving

gres fine porcellanato colorato in massa - rettificato monocalibro / colorbody fine porcelain stoneware - rectified monocaliber / durchgefärbtes feinsteinzeug - rektifiziert, in einem werkmaß / grès cérame fin coloré dans la masse - rectifié monocalibre / gres porcelánico fino coloreado en toda la masa - rectificado monocalibre / гомогенный мелкозернистый керамогранит - ректифицированный монокалиберный

gruppo Bla UNI EN 14411\_G



30x120 cm  
11<sup>13</sup>/<sub>16</sub>"x47<sup>1</sup>/<sub>4</sub>"  
± 9,5 mm

20x120 cm  
7<sup>7</sup>/<sub>8</sub>"x47<sup>1</sup>/<sub>4</sub>"  
± 9,5 mm

15x120 cm  
5<sup>7</sup>/<sub>8</sub>"x47<sup>1</sup>/<sub>4</sub>"  
± 9,5 mm

XT20  
Woodliving XT20  
> p.442

# Woodliving

30x120 - 11<sup>13</sup>/<sub>16</sub>"x47<sup>1</sup>/<sub>4</sub>" 20x120 - 7<sup>7</sup>/<sub>8</sub>"x47<sup>1</sup>/<sub>4</sub>" 15x120 - 5<sup>7</sup>/<sub>8</sub>"x47<sup>1</sup>/<sub>4</sub>"

## Rovere Biondo



**R3ZZ** 30x120 Rett  
**R40F** 20x120 Rett  
**R40L** 15x120 Rett



**R40W** 7x60 BT.B.C.



**R41C** 32,5x120x4 GR.

## Rovere Ghiaccio



**R3ZV** 30x120 Rett  
**R40A** 20x120 Rett  
**R40G** 15x120 Rett



**R40S** 7x60 BT.B.C.



**R40X** 32,5x120x4 GR.

## Rovere Scuro



**R3ZY** 30x120 Rett  
**R40E** 20x120 Rett  
**R40K** 15x120 Rett



**R40V** 7x60 BT.B.C.



**R41A** 32,5x120x4 GR.

## Rovere Fumo



**R3ZW** 30x120 Rett  
**R40C** 20x120 Rett  
**R40H** 15x120 Rett



**R40T** 7x60 BT.B.C.



**R40Y** 32,5x120x4 GR.

## Rovere Tortora



**R3ZX** 30x120 Rett  
**R40D** 20x120 Rett  
**R40J** 15x120 Rett



**R40U** 7x60 BT.B.C.



**R40Z** 32,5x120x4 GR.

# Woodliving



R3ZX Rovere Tortora Rettificato 30x120 - 11<sup>13/16</sup>"x47<sup>1/4</sup>"

## TECH INFO

VARIAZIONI CROMATICHE / COLOUR VARIATIONS / FARBVARIATIONEN / VARIATIONS CHROMATIQUES / VARIACIONES CROMÁTICAS / ВАРИАНТЫ ОТТЕНКА



V2

Apprezzabili differenze nell'aspetto di superficie e grafica all'interno della stessa produzione / Clearly distinguishable differences in texture and pattern within the same production run / Auffällige Unterschiede in Aussehen und Struktur innerhalb der gleichen Produktionscharge / Différences visibles au niveau de l'aspect et de la fantaisie entre les carreaux du même lot de production / Diferencias visibles en el aspecto de la superficie y los motivos dentro de un mismo lote de producción / Заметные отличия вида поверхности и графики в одной и той же партии

DESTINAZIONE D'USO / INTENDED USE / ANWENDUNGSBEREICH / CHAMP D'APPLICATION / USO PREVISTO / НАЗНАЧЕНИЕ

### G (Naturale/Matt)

Materiali consigliati per locali sottoposti a sollecitazioni all'abrasione medio pesanti come: case individuali, commerciale leggero / Materials recommended for premises with medium-heavy abrasion levels, such as: detached homes, light-traffic commercial premises / Empfohlen für Räume mit mittelschwerer Abriebbeanspruchung wie: Einfamilienhäuser, leicht beanspruchte Gewerbebereiche / Matériaux recommandés pour des locaux soumis à des contraintes d'abrasion moyennes et fortes comme : maisons particulières, espaces commerciaux soumis à un trafic léger, etc / Materiales recomendados para locales sometidos a esfuerzos de abrasión medio-pesados, como casas unifamiliares y locales comerciales de tráfico ligero / Материалы рекомендованы для использования в частных домах и коммерческих помещениях, подверженных средне-сильному абразивному воздействию

PEZZI SPECIALI / TRIMS / SPEZIALTEILE / PIÈCES SPÉCIALES / PIEZAS ESPECIALES / СПЕЦИАЛЬНЫЕ ИЗДЕЛИЯ

### BT.B.C.

Battiscopa Becco Civetta ottenuto da taglio del fondo / Coved Edge Skirting Tile cut from plain tile / Sockelleiste, Halbrundstab, aus Grundfliese geschnitten / Plinthe bord rond découpée dans le fond / Rodapié canto romo conseguido mediante corte del fondo / Плинтус с закругленным краем, полученный из фоновой плитки

### GR.

Gradone lineare tagliato ed assemblato / Two-piece straight step / Stufenplatte gerade geschnitten und zusammengesetzt / Large marche droite coupée et assemblée / Escalón lineal cortado y montado / Собранный загибающаяся линейная ступень со срезом

CARATTERISTICHE / CHARACTERISTICS / EIGENSCHAFTEN / CARACTERISTIQUES / DATOS / ХАРАКТЕРИСТИКИ

	R9	PENDULUM classe 2	D-COF > 0,42	BCR $\mu > 0,40$
	$\leq 175 \text{ mm}^3$			

CERTIFICAZIONI / CERTIFICATIONS / ZERTIFIZIERUNGEN / CERTIFICACIONES / СЕРТИФИКАЦИИ



IMBALLI / PACKAGING / VERPACKUNGEN / EMBALLAGES / EMBALAJES / УПАКОВКИ

		scatole / box / karton / boîte / caja / коробк			pallet / pallet / palette / palette / pallet / поддон			
		□	M <sup>2</sup>	KG	□	M <sup>2</sup>	KG	± mm
30x120	Rettificato	3	1,08	22,99	48	51,84	1103,52	9,5
20x120	Rettificato	3	0,72	15,57	60	43,20	934,00	9,5
15x120	Rettificato	6	1,08	22,68	40	43,20	907,00	9,5
7x60	BT.B.C.	14	8,40 ml	14,73	-	-	-	9,5
32,5x120x4	GR.	2	0,78	17,69	-	-	-	-

WOOD EFFECT

# Woodtale



R4TQ Quercia Rettificato 20x120 - 7<sup>78</sup> x 47<sup>1/4</sup>" - R4ST Bistrot Calacatta Michelangelo 7x28 - 2<sup>34</sup> x 11<sup>1/32</sup>"



## Woodtale

gres fine porcellanato colorato in massa - rettificato monocalibro / colorbody fine porcelain stoneware - rectified monocaliber / durchgefärbtes feinsteinzeug - rektifiziert, in einem werkmaß / grès cérame fin coloré dans la masse - rectifié monocalibre / gres porcelánico fino coloreado en toda la masa - rectificado monocalibre / гомогенный мелкозернистый керамогранит - ректифицированный монокалиберный

gruppo Bia UNI EN 14411\_G



30x120 cm  
11<sup>13/16</sup> x 47<sup>1/4</sup>"  
± 9,5 mm

20x120 cm  
7<sup>7/8</sup> x 47<sup>1/4</sup>"  
± 9,5 mm

15x120 cm  
5<sup>7/8</sup> x 47<sup>1/4</sup>"  
± 9,5 mm

XT20  
Woodtale XT20  
> p.446

# Woodtale

30x120 - 11<sup>13</sup>/<sub>16</sub>"x47<sup>1</sup>/<sub>4</sub>" 20x120 - 7<sup>7</sup>/<sub>8</sub>"x47<sup>1</sup>/<sub>4</sub>" 15x120 - 5<sup>7</sup>/<sub>8</sub>"x47<sup>1</sup>/<sub>4</sub>"

## Betulla



R4TG 30x120 Rett  
R4TM 20x120 Rett  
R4TS 15x120 Rett



R4XU 7x60 BT.B.C.



R4XP 32,5x120x4 GR.

## Quercia



R4TK 30x120 Rett  
R4TQ 20x120 Rett  
R4TV 15x120 Rett



R4XX 7x60 BT.B.C.



R4XS 32,5x120x4 GR.

## Miele



R4TH 30x120 Rett  
R4TN 20x120 Rett  
R4TT 15x120 Rett



R4XV 7x60 BT.B.C.



R4XQ 32,5x120x4 GR.

## Noce



R4TL 30x120 Rett  
R4TR 20x120 Rett  
R4TW 15x120 Rett



R4XY 7x60 BT.B.C.



R4XT 32,5x120x4 GR.

## Nocciola



R4TJ 30x120 Rett  
R4TP 20x120 Rett  
R4TU 15x120 Rett



R4XW 7x60 BT.B.C.



R4XR 32,5x120x4 GR.

# Woodtale



WOODTALE | WOOD EFFECT

WOODTALE | WOOD EFFECT

R4TQ Quercia Rettificato 20x120 - 7<sup>me</sup> x 47<sup>1/4"</sup>

## TECH INFO

VARIAZIONI CROMATICHE / COLOUR VARIATIONS / FARBVARIATIONEN / VARIATIONS CHROMATIQUES / VARIACIONES CROMÁTICAS / ВАРИАНТЫ ОТТЕНКА



Significativa variazione di aspetto superficiale, grafica e colore da piastrella a piastrella e all'interno della stessa piastrella. Si consiglia di visionare la gamma cromatica prima della selezione del materiale / Significant variation in texture, pattern and colour from tile to tile within the same production run. The colour range should be viewed before selecting the material / Bedeutende Variation in Aussehen, Struktur und Farbe von Fliese zu Fliese und in ein und derselben Fliese. Es wird empfohlen, das Farbsortiment vor der Auswahl des Materials zu prüfen / Variation significative au niveau de l'aspect, de la fantaisie et de la couleur entre les carreaux et au sein d'un même carreau. Il est recommandé de consulter la gamme des couleurs avant de sélectionner le matériel / Variación considerable en el aspecto superficial, los motivos y el color entre un azulejo y otro y dentro del propio azulejo. Es aconsejable visualizar la gama cromática antes de seleccionar el material / Значительные отличия вида поверхности, графики и цвета у разных плиток и на одной и той же плитке. Перед отбором материала рекомендуется посмотреть цветовую гамму

DESTINAZIONE D'USO / INTENDED USE / ANWENDUNGSBEREICH / CHAMP D'APPLICATION / USO PREVISTO / НАЗНАЧЕНИЕ

### H (Naturale/Matt)

Materiali consigliati per sollecitazioni all'abrasione relativamente forti in ambienti anche non protetti da agenti graffianti / Materials recommended for relatively heavy abrasion levels, also in premises not protected against abrasive substances / Empfohlen für starke Abriebbeanspruchungen in Bereichen auch ohne Kratzschutzbehandlung / Matériaux recommandés pour des locaux soumis à des fortes contraintes d'abrasion, même non protégés contre les agents abrasifs / Materiales recomendados para soportar esfuerzos de abrasión relativamente intensos incluso en espacios no protegidos frente a agentes abrasivos. / Материалы рекомендованы для относительно сильного абразивного воздействия, в том числе в помещениях, не защищенных от царапающих элементов.

PEZZI SPECIALI / TRIMS / SPEZIALTEILE / PIÈCES SPÉCIALES / PIEZAS ESPECIALES / СПЕЦИАЛЬНЫЕ ИЗДЕЛИЯ

### BT.B.C.

Battiscopa Becco Civetta ottenuto da taglio del fondo / Coved Edge Skirting Tile cut from plain tile / Sockelleiste, Halbrundstab, aus Grundfliese geschnitten / Plinthe bord rond découpée dans le fond / Rodapié canto romo conseguido mediante corte del fondo / Плинтус с закругленным краем, полученный из фоновой плитки

### GR.

Gradone lineare tagliato ed assemblato / Two-piece straight step / Stufenplatte gerade geschnitten und zusammengesetzt / Large marche droite coupée et assemblée / Escalón lineal cortado y montado / Собранный загибающаяся линейная ступень со срезом

CARATTERISTICHE / CHARACTERISTICS / EIGENSCHAFTEN / CARACTERISTIQUES / DATOS / ХАРАКТЕРИСТИКИ

R9	PENDULUM classe 1	D-COF > 0,42	BCR $\mu > 0,40$
$\leq 175 \text{ mm}^2$			

CERTIFICAZIONI / CERTIFICATIONS / ZERTIFIZIERUNGEN / CERTIFICACIONES / СЕРТИФИКАЦИИ



IMBALLI / PACKAGING / VERPACKUNGEN / EMBALLAGES / EMBALAJES / УПАКОВКИ

		scatole / box / karton / boîte / caja / короб			pallet / pallet / palette / palette / pallet / поддон			
		□	M <sup>2</sup>	KG	□	M <sup>2</sup>	KG	± mm
30x120	Rettificato	3	1,08	22,99	48	51,84	1103,52	9,5
20x120	Rettificato	3	0,72	15,57	60	43,20	934,00	9,5
15x120	Rettificato	6	1,08	22,68	40	43,20	907,00	9,5
7x60	BT.B.C.	14	8,40 ml	14,73	-	-	-	9,5
32,5x120x4	GR.	2	0,78	7,69	-	-	-	-

WOOD EFFECT

# Woodmania



R56A Honey 20x120 - 7<sup>16</sup>°x47<sup>14</sup>°



## Woodmania

gres fine porcellanato colorato in massa / colorbody fine porcelain stoneware / durchgefärbtes feinsteinzeug in einem werkmaß / grès cérame fin coloré dans la masse / gres porcelánico fino coloreado en toda la masa / гомогенный мелкозернистый керамогранит

gruppo Bla UNI EN 14411\_G



naturale/ outdoor matt



20x120 cm  
7<sup>16</sup>°x47<sup>14</sup>°  
± 9,5 mm

XT20  
Woodmania XT20  
> p.450

# Woodmania

20x120 - 7<sup>16</sup> x 47<sup>14</sup>"

## Ivory



**R55Z** 20x120  
**R56L** 20x120 Grip



**R56F** 6x60 BT.B.C.



**R14A** 15x120x4 E.ELLE

## Musk



**R56D** 20x120  
**R56P** 20x120 Grip



**R56J** 6x60 BT.B.C.



**R14E** 15x120x4 E.ELLE

## Honey



**R56A** 20x120  
**R56M** 20x120 Grip



**R56G** 6x60 BT.B.C.



**R14C** 15x120x4 E.ELLE

## Ash



**R56E** 20x120  
**R56Q** 20x120 Grip



**R56K** 6x60 BT.B.C.

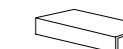

**R14F** 15x120x4 E.ELLE

## Caramel



**R56C** 20x120  
**R56N** 20x120 Grip



**R56H** 6x60 BT.B.C.



**R14D** 15x120x4 E.ELLE

CONSIGLI DI POSA / INSTALLATION ADVICE / HINWEISE ZUR VERLEGUNG / CONSEILS DE POSE / SUGERENCIAS PARA LA COLOCACIÓN / РЕКОМЕНДАЦИИ ПО УКЛАДКЕ

Per le pavimentazioni esterne non protette, Ragno consiglia di creare una pendenza  $\geq 1,5\%$  sulla superficie calpestabile allo scopo di limitare il formarsi di ristagni d'acqua localizzati. Nel caso in cui questi ristagni permangano sulla superficie delle piastrelle nonostante una posa a regola d'arte, è necessario intervenire meccanicamente con l'utilizzo di scope o aspira-liquidi / For unprotected outdoor pavings, Ragno recommends the creation of a gradient of  $\geq 1.5\%$  on the finished surface, to prevent the formation of patches of standing water. In the event that standing water persists on the surface of the tiles in spite of correct installation, it must be removed mechanically with the aid of brooms or wet-and-dry vacuum cleaners / Zur Unterbindung von punktueller Stauwasserbildung bei Belägen in ungeschützten Außenbereichen, empfiehlt die Ragno die Ausbildung eines Gefälles  $\geq 1,5\%$  auf der Trittlfläche. Sollte trotz fachgerechter Verlegung Stauwasser auf der Fliesenoberfläche zurückbleiben, ist dessen mechanische Entfernung mit Hilfe eines Besens oder Nasssaugers erforderlich / Pour des sols extérieurs non protégés, Ragno conseille de créer une inclinaison  $\geq 1,5\%$  sur la surface de piétinement en vue de limiter la stagnation localisée de l'eau. Si, malgré une pose dans les règles de l'art, cette stagnation devait persister à la surface des carreaux, une intervention mécanique, au moyen de balais et d'aspirateurs de liquides, est alors nécessaire / En el caso de pavimentaciones exteriores no protegidas, Ragno recomienda crear una pendiente  $\geq 1,5\%$  en la superficie transitable para limitar la formación de depósitos localizados de agua estancada. En caso de que estos depósitos de agua permanezcan en la superficie del azulejo, aun cuando la colocación se haya realizado correctamente, será necesario intervenir mecánicamente empleando un cepillo o un aspirador de líquidos / Для наружных незащищенных полов Ragno рекомендует создавать уклон  $\geq 1,5\%$  на пешеходной поверхности для снижения образования локальных застоев воды. В случае, если застои воды образуются на плитке несмотря на правильную укладку, необходимо прибегать к использованию механических средств, таких как щетки или же аппараты для сбора жидкостей



# Woodmania

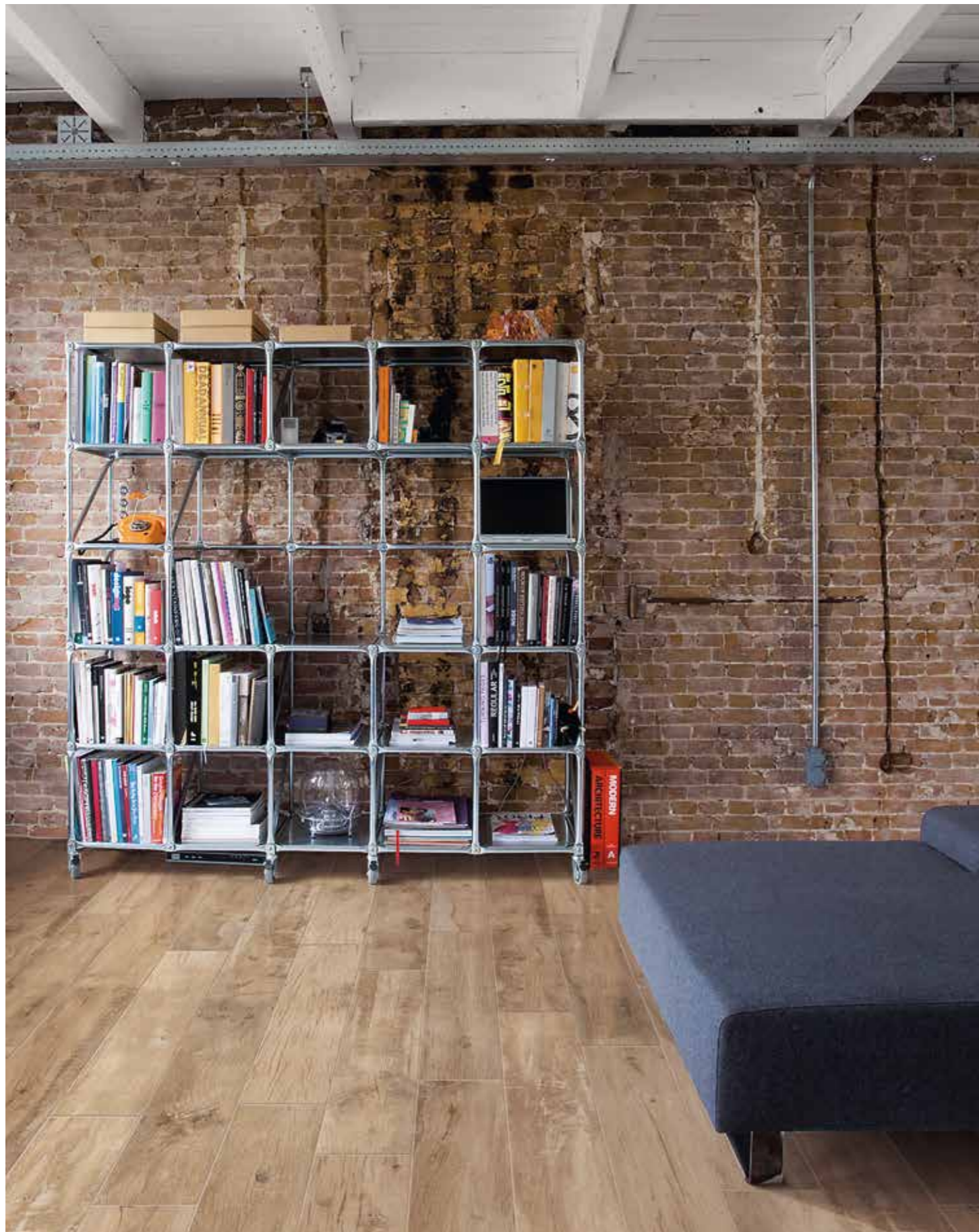

R56A Honey 20x120 - 778°x47°/4°

## TECH INFO

VARIAZIONI CROMATICHE / COLOUR VARIATIONS / FARBVARIATIONEN / VARIATIONS CHROMATIQUES / VARIACIONES CROMÁTICAS / ВАРИАНТЫ ОТТЕККА



**V4**  
 Variazioni irregolari da piastrella a piastrella. Una piastrella può differire totalmente nell'aspetto superficiale e colore da un'altra. Si consiglia di visionare la gamma cromatica prima della selezione del materiale / Random differences from tile to tile. One tile may have totally different texture and colour from another. The colour range should be viewed before selecting the material / Wesentliche Variationen von Fliese zu Fliese. Eine Fliese kann sich in Aussehen und Farbe komplett von einer anderen unterscheiden. Es wird empfohlen, das Farbsortiment vor der Auswahl des Materials zu prüfen / Variations irrégulières entre les carreaux. L'aspect et la couleur peuvent être complètement différents d'un carreau à l'autre. Il est recommandé de consulter la gamme des couleurs avant de sélectionner le matériel / Variaciones irregulares entre un azulejo y otro. Un azulejo puede ser completamente diferente de otro en el aspecto superficial y el color. Es aconsejable visualizar la gama cromática antes de seleccionar el material / Неоднородные изменения на разных плитках. Каждая плитка может полностью отличаться по виду поверхности и цвету от другой. Перед отбором материала рекомендуется посмотреть цветовую гамму

DESTINAZIONE D'USO / INTENDED USE / ANWENDUNGSBEREICH / CHAMP D'APPLICATION / USO PREVISTO / НАЗНАЧЕНИЕ

### H (Ivory: Naturale/Matt. Honey: Naturale/Matt, Grip)

Materiali consigliati per sollecitazioni all'abrasione relativamente forti in ambienti anche non protetti da agenti graffianti / Materials recommended for relatively heavy abrasion levels, also in premises not protected against abrasive substances / Empfohlen für starke Abriebbeanspruchungen in Bereichen auch ohne Kratzschutzbehandlung / Matériaux recommandés pour des locaux soumis à des fortes contraintes d'abrasion, même non protégés contre les agents abrasifs / Materiales recomendados para soportar esfuerzos de abrasión relativamente intensos incluso en espacios no protegidos frente a agentes abrasivos. / Материалы рекомендованы для относительно сильного абразивного воздействия, в том числе в помещениях, не защищенных от царапающих элементов.

### G (Caramel, Musk, Ash: Naturale/Matt. Ivory: Grip)

Materiali consigliati per locali sottoposti a sollecitazioni all'abrasione medio pesanti come: case individuali, commerciale leggero / Materials recommended for premises with medium-heavy abrasion levels, such as: detached homes, light-traffic commercial premises / Empfohlen für Räume mit mittelschwerer Abriebbeanspruchung wie: Einfamilienhäuser, leicht beanspruchte Gewerbebereiche / Matériaux recommandés pour des locaux soumis à des contraintes d'abrasion moyennes et fortes comme : maisons particulières, espaces commerciaux soumis à un trafic léger, etc / Materiales recomendados para locales sometidos a esfuerzos de abrasión medio-pesados, como casas unifamiliares y locales comerciales de tráfico ligero / Материалы рекомендованы для использования в частных домах и коммерческих помещениях, подверженных средне-сильному абразивному воздействию

### F (Caramel, Musk, Ash: Grip)

Materiali consigliati per qualsiasi locale di un'abitazione che non abbia collegamenti diretti con l'esterno o accessi non protetti da zerbini. Medie sollecitazioni all'abrasione / Tiles suitable for any room of a house without direct access from the outside or access not protected by doormats. Mean stress abrasive wear / Für alle Räume des Wohnbereichs empfohlen, zu denen man keinen direkten Zutritt von außen hat oder welche nicht durch Fußteppiche abgegrenzt sind. Mittlere Abriebbeanspruchung / Matériaux conseillés pour toutes les pièces d'une maison qui n'a pas d'accès directs par l'extérieur ou non protégés par des paillasons. Abrasion sous contraintes moyennes / Materiales aconsejados para cualquier habitación de una vivienda sin accesos directos desde el exterior o accesos no protegidos por felpudos. Esfuerzos medianos por abrasión / Материалы рекомендованы для любых жилых помещений, не имеющих прямого выхода на улицу или же доступа без входных ковриков. Среднее абразивное воздействие. в частных домах и коммерческих помещениях, подверженных средне-сильному абразивному воздействию

PEZZI SPECIALI / TRIMS / SPEZIALTEILE / PIÈCES SPÉCIALES / PIEZAS ESPECIALES / СПЕЦИАЛЬНЫЕ ИЗДЕЛИЯ

### BT.B.C.

Battiscopa Becco Civetta ottenuto da taglio del fondo / Coved Edge Skirting Tile cut from plain tile / Sockelleiste, Halbrundstab, aus Grundfliese geschnitten / Plinthe bord rond découpée dans le fond / Rodapié canto romo conseguido mediante corte del fondo / Плинтус с закругленным краем, полученный из фоновой плитки

### E.Elle

Elemento ad Elle tagliato ed assemblato / Two-piece L-Tile / Schenkelplatte, geschnitten und zusammengesetzt / Élément en L coupé et assemblé / Elemento en forma de "L" cortado y montado / Г-образный элемент, состоящий из двух частей  
 Solo su richiesta / To order only / Nur auf Anfrage / Sur demande uniquement / solo bajo pedido / только по заказу

CARATTERISTICHE / CHARACTERISTICS / EIGENSCHAFTEN / CARACTERISTIQUES / DATOS / ХАРАКТЕРИСТИКИ

R10 Naturale/Matt R11 Grip	PENDULUM classe 2 Naturale classe 3 Grip ptv > 36	D-COF > 0,42	BCR μ > 0,40
C Grip			
≤ 175 mm <sup>2</sup>			

CERTIFICAZIONI / CERTIFICATIONS / ZERTIFIZIERUNGEN / CERTIFICACIONES / СЕРТИФИКАЦИИ



IMBALLI / PACKAGING / VERPACKUNGEN / EMBALLAGES / EMBALAJES / УПАКОВКИ

	scatole / box / karton / boîte / caja / короб			pallet / pallet / palette / palette / pallet / поддон			
	□	M <sup>2</sup>	KG	□	M <sup>2</sup>	KG	± mm
20x120	4	0,96	20,05	40	38,40	801,84	9,5
20x120 Grip	4	0,96	20,05	40	38,40	801,84	9,5
6x60 BT.B.C.	14	8,40 ml	14,56	-	-	-	9,5
32,5x120x4 GR.	2	0,36	17,00	-	-	-	-

WOOD EFFECT

# Woodsoft



R14H Bianco Rettificato 20x120 - 7<sup>16</sup> x 47<sup>14</sup>



## Woodsoft

gres fine porcellanato colorato in massa - rettificato monocalibro / colorbody fine porcelain stoneware - rectified monocaliber / durchgefärbtes feinsteinzeug - rektifiziert, in einem werkmaß / grès cérame fin coloré dans la masse - rectifié monocalibre / gres porcelánico fino coloreado en toda la masa - rectificado monocalibre / гомогенный мелкозернистый керамогранит - ректифицированный монокалиберный  
gruppo Bla UNI EN 14411\_G



20x120 cm  
7<sup>16</sup> x 47<sup>14</sup>  
± 9,5 mm

# Woodsoft

Bianco



R14H 20x120



R19J 6x60 BT.B.C.

Tortora



R13Z 20x120



R19M 6x60 BT.B.C.

20x120 - 7<sup>16</sup>/<sub>16</sub> x 47<sup>14</sup>/<sub>16</sub>"

Beige Ch.



R14J 20x120



R19K 6x60 BT.B.C.

Grigio



R14I 20x120



R19N 6x60 BT.B.C.

Beige Sc.



R14K 20x120



R19L 6x60 BT.B.C.

# Woodsoft

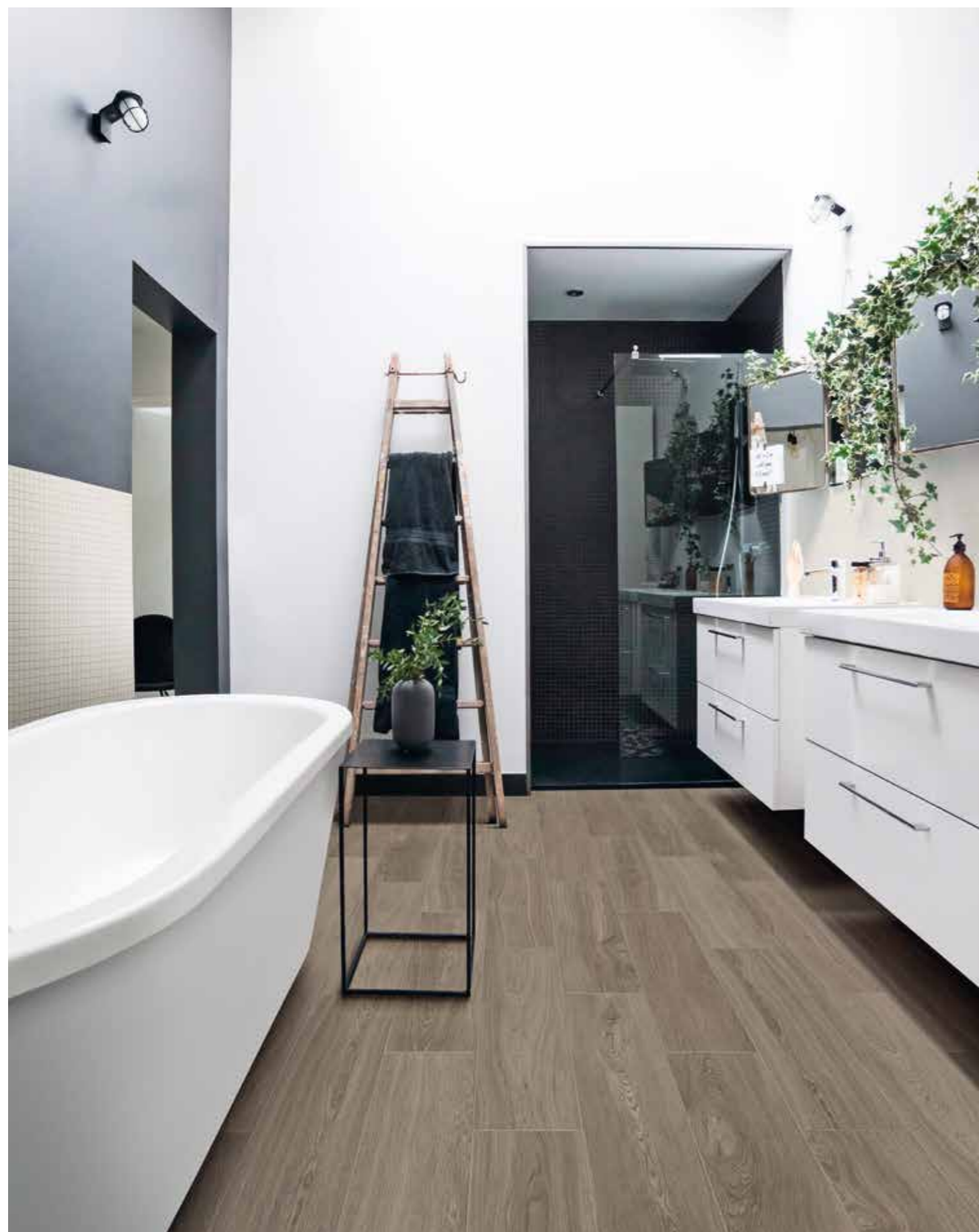

WOODSOFT | WOOD EFFECT

WOODSOFT | WOOD EFFECT

R13Z Woodsoft Tortora Rettificato 20x120 - 7<sup>38</sup> x47<sup>14</sup> - R02X Flex Cenere 25x76 - 9<sup>13/16</sup> x29<sup>15/16</sup> - R07C Flex Mosaico Cenere 30x30 - 11<sup>31/64</sup> x11<sup>31/64</sup>

## TECH INFO

VARIAZIONI CROMATICHE / COLOUR VARIATIONS / FARBVARIATIONEN / VARIATIONS CHROMATIQUES / VARIACIONES CROMÁTICAS / ВАРИАНТЫ ОТТЕНКА



Apprezzabili differenze nell'aspetto di superficie e grafica all'interno della stessa produzione / Clearly distinguishable differences in texture and pattern within the same production run / Auffällige Unterschiede in Aussehen und Struktur innerhalb der gleichen Produktionscharge / Différences visibles au niveau de l'aspect et de la fantaisie entre les carreaux du même lot de production / Diferencias visibles en el aspecto de la superficie y los motivos dentro de un mismo lote de producción / заметные отличия вида поверхности и графики в одной и той же партии

DESTINAZIONE D'USO / INTENDED USE / ANWENDUNGSBEREICH / CHAMP D'APPLICATION / USO PREVISTO / НАЗНАЧЕНИЕ

### H (Naturale/Matt)

Materiali consigliati per sollecitazioni all'abrasione relativamente forti in ambienti anche non protetti da agenti graffianti / Materials recommended for relatively heavy abrasion levels, also in premises not protected against abrasive substances / Materials recommended for relatively heavy abrasion levels, also in premises not protected against abrasive substances / Empfohlen für starke Abriebbeanspruchungen in Bereichen auch ohne Kratzschutzbehandlung / Matériaux recommandés pour des locaux soumis à des fortes contraintes d'abrasion, même non protégés contre les agents abrasifs / Materiales recomendados para soportar esfuerzos de abrasión relativamente intensos incluso en espacios no protegidos frente a agentes abrasivos / Материалы рекомендованы для относительно сильного абразивного воздействия, в том числе в помещениях, не защищенных от царапающих элементов

PEZZI SPECIALI / TRIMS / SPEZIALTEILE / PIÈCES SPÉCIALES / PIEZAS ESPECIALES / СПЕЦИАЛЬНЫЕ ИЗДЕЛИЯ

### BT.B.C.

Battiscopa Becco Civetta ottenuto da taglio del fondo / Coved Edge Skirting Tile cut from plain tile / Sockelleiste, Halbrundstab, aus Grundfliese geschnitten / Plinthe bord rond découpée dans le fond / Rodapié canto romo conseguido mediante corte del fondo / Плинтус с закругленным краем, полученный из фоновой плитки

CARATTERISTICHE / CHARACTERISTICS / EIGENSCHAFTEN / CARACTERÍSTICAS / DATOS / ХАРАКТЕРИСТИКИ

	R9	PENDULUM classe 1	D-COF > 0,42	BCR $\mu > 0,40$
	$\leq 175 \text{ mm}^2$			

CERTIFICAZIONI / CERTIFICATIONS / ZERTIFIZIERUNGEN / CERTIFICACIONES / CERTIFICACIONES / СЕРТИФИКАЦИИ



IMBALLI / PACKAGING / VERPACKUNGEN / EMBALLAGES / EMBALAJES / УПАКОВКИ

		scatole / box / karton / boîte / caja / короб			pallet / pallet / palette / palette / pallet / поддон			
		□	M <sup>2</sup>	KG	□	M <sup>2</sup>	KG	± mm
20x120		4	0,96	24,00	40	38,40	960,00	9,5
6x60	BT.B.C.	14	8,40 ml	12,50	-	-	-	9,5

WOOD EFFECT

# Woodplace



R497 Caramel 20x120 - 7<sup>16</sup> x 47<sup>14</sup>



## Woodplace

gres fine porcellanato colorato in massa / colorbody fine porcelain stoneware / durchgefärbtes feinsteinzeug in einem werkmaß / grès cérame fin coloré dans la masse / gres porcelánico fino coloreado en toda la masa / гомогенный мелкозернистый керамогранит

gruppo Bla UNI EN 14411\_6



naturale/  
matt



20x120 cm

7<sup>16</sup> x 47<sup>14</sup>

± 9 mm

# Woodplace

Bianco



R48Z 20x120



R49C 6x60 BT.B.C.

Sughero



R499 20x120



R49F 6x60 BT.B.C.

20x120 - 7<sup>16</sup> x 47<sup>14</sup>"

Caramel



R497 20x120



R49D 6x60 BT.B.C.

Caffé



R49A 20x120



R49G 6x60 BT.B.C.

Cognac



R498 20x120



R49E 6x60 BT.B.C.

# Woodplace



R499 Sughero 20x120 - 7<sup>th</sup> x47<sup>th</sup>

## TECH INFO

VARIAZIONI CROMATICHE / COLOUR VARIATIONS / FARBVARIATIONEN / VARIATIONS CHROMATIQUES / VARIACIONES CROMÁTICAS / ВАРИАНТЫ ОТТЕНКА



Significativa variazione di aspetto superficiale, grafica e colore da piastrella a piastrella e all'interno della stessa piastrella. Si consiglia di visionare la gamma cromatica prima della selezione del materiale / Significant variation in texture, pattern and colour from tile to tile within the same production run. The colour range should be viewed before selecting the material / Bedeutende Variation in Aussehen, Struktur und Farbe von Fliese zu Fliese und in ein und derselben Fliese. Es wird empfohlen, das Farbsortiment vor der Auswahl des Materials zu prüfen / Variation significative au niveau de l'aspect, de la fantaisie et de la couleur entre les carreaux et au sein d'un même carreau. Il est recommandé de consulter la gamme des couleurs avant de sélectionner le matériel / Variación considerable en el aspecto superficial, los motivos y el color entre un azulejo y otro y dentro del propio azulejo. Es aconsejable visualizar la gama cromática antes de seleccionar el material / Значительные отличия вида поверхности, графики и цвета у разных плиток и на одной и той же плитке. Перед отбором материала рекомендуется посмотреть цветовую гамму

DESTINAZIONE D'USO / INTENDED USE / ANWENDUNGSBEREICH / CHAMP D'APPLICATION / USO PREVISTO / НАЗНАЧЕНИЕ

### H (Naturale/Matt)

Materiali consigliati per sollecitazioni all'abrasione relativamente forti in ambienti anche non protetti da agenti graffianti / Materials recommended for relatively heavy abrasion levels, also in premises not protected against abrasive substances / Empfohlen für starke Abriebbeanspruchungen in Bereichen auch ohne Kratzschutzbehandlung / Matériaux recommandés pour des locaux soumis à des fortes contraintes d'abrasion, même non protégés contre les agents abrasifs / Materiales recomendados para soportar esfuerzos de abrasión relativamente intensos incluso en espacios no protegidos frente a agentes abrasivos. / Материалы рекомендованы для относительно сильного абразивного воздействия, в том числе в помещениях, не защищенных от царапающих элементов.

PEZZI SPECIALI / TRIMS / SPEZIALTEILE / PIÈCES SPÉCIALES / PIEZAS ESPECIALES / СПЕЦИАЛЬНЫЕ ИЗДЕЛИЯ

### BT.B.C.

Battiscopa Becco Civetta ottenuto da taglio del fondo / Coved Edge Skirting Tile cut from plain tile / Sockelleiste, Halbrundstab, aus Grundfliese geschnitten / Plinthe bord rond découpée dans le fond / Rodapié canto romo conseguido mediante corte del fondo / Плинтус с закругленным краем, полученный из фоновой плитки

CARATTERISTICHE / CHARACTERISTICS / EIGENSCHAFTEN / CARACTERISTIQUES / DATOS / ХАРАКТЕРИСТИКИ

R9	PENDULUM classe 2 ptv > 36
≤ 175 mm <sup>2</sup>	

CERTIFICAZIONI / CERTIFICATIONS / ZERTIFIZIERUNGEN / CERTIFICATIONS / CERTIFICACIONES / СЕРТИФИКАЦИИ



IMBALLI / PACKAGING / VERPACKUNGEN / EMBALLAGES / EMBALAJES / УПАКОВКИ

		scatole / box / karton / boîte / caja / короб			pallet / pallet / palette / palette / pallet / поддон			
		□	M <sup>2</sup>	KG	□	M <sup>2</sup>	KG	± mm
20x120		4	0,96	19,72	40	38,40	788,80	9
6x60	BT.B.C.	14	8,40 ml	14,56	-	-	-	9

WOOD EFFECT

# Woodclassic



R5RX Marrone 10x100 / 13x100 - 3<sup>15</sup>/<sub>16</sub>"x39<sup>38</sup>" / 5<sup>16</sup>"x39<sup>38</sup>"



## Woodclassic

gres porcellanato / porcelain stoneware / feinsteinzeug / grès cérame émaillé / gres porcelánico / керамогранит  
gruppo Bla UNI EN 14411\_6



10x100 cm  
3<sup>15</sup>/<sub>16</sub>"x39<sup>38</sup>"  
± 9 mm

13x100 cm  
5<sup>16</sup>"x39<sup>38</sup>"  
± 9 mm



# Woodclassic

10x100 - 3<sup>15</sup>/<sub>16</sub>" x 39<sup>3</sup>/<sub>8</sub>" 13x100 - 5<sup>1</sup>/<sub>8</sub>" x 39<sup>3</sup>/<sub>8</sub>"

**Bianco**



R5RV 10x100 / 13x100



R5YA 5x100 BT.B.C.

**Tortora**



R5RY 10x100 / 13x100



R5YF 5x100 BT.B.C.

**Beige**



R5RW 10x100 / 13x100



R5YD 5x100 BT.B.C.

**Grigio**



R5RZ 10x100 / 13x100



R5YG 5x100 BT.B.C.

**Marrone**



R5RX 10x100 / 13x100



R5YE 5x100 BT.B.C.

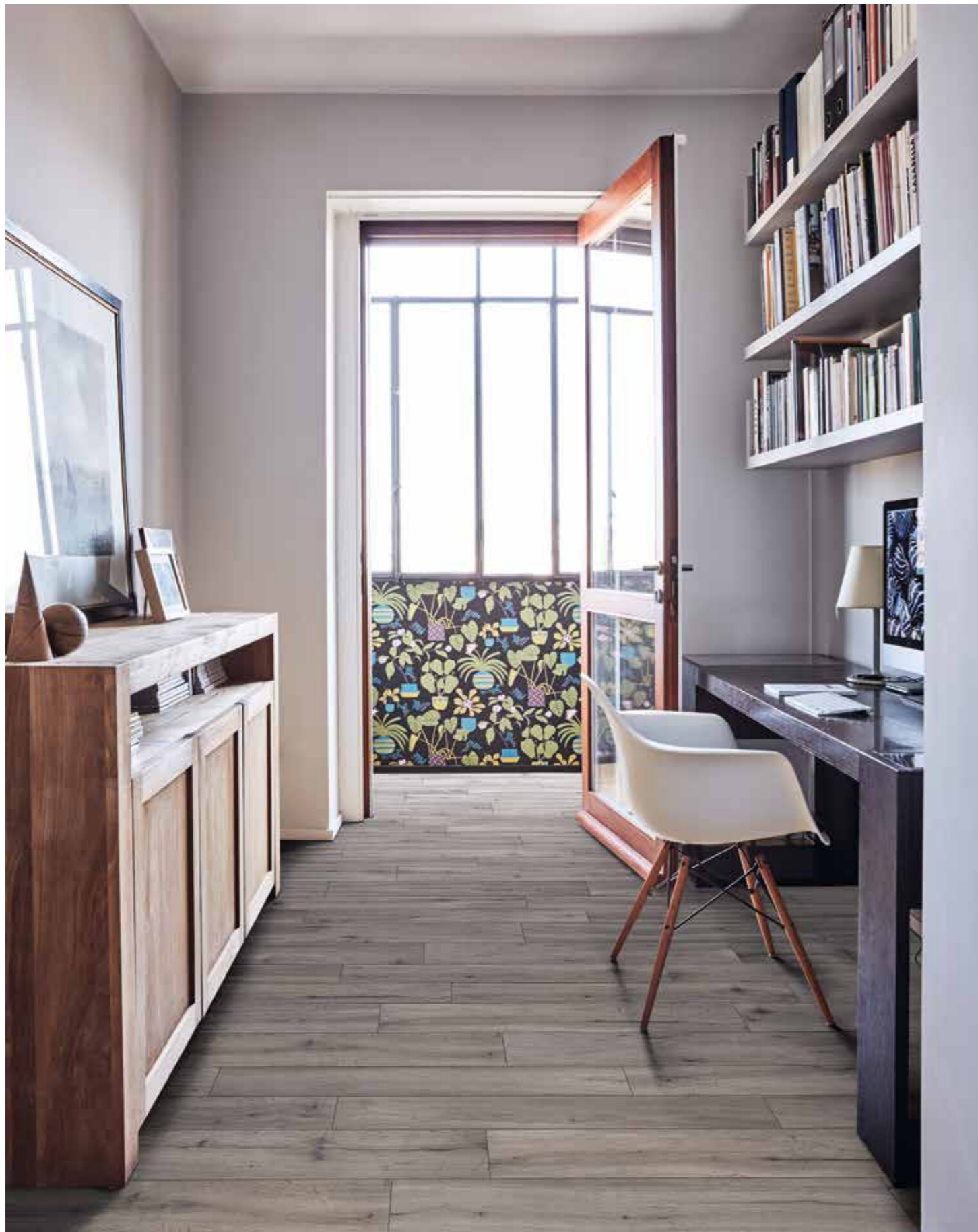

R5RY Tortora 10x100 / 13x100 - 3<sup>15/16</sup> x 39<sup>3/8</sup> / 5<sup>18</sup> x 39<sup>3/8</sup>

TECH INFO

VARIAZIONI CROMATICHE / COLOUR VARIATIONS / FARBVARIATIONEN / VARIATIONS CHROMATIQUES / VARIACIONES CROMÁTICAS / ВАРИАНТЫ ОТТЕНКА



**V2**  
 Apprezzabili differenze nell'aspetto di superficie e grafica all'interno della stessa produzione / Clearly distinguishable differences in texture and pattern within the same production run / Auffällige Unterschiede in Aussehen und Struktur innerhalb der gleichen Produktionscharge / Différences visibles au niveau de l'aspect et de la fantaisie entre les carreaux du même lot de production / Diferencias visibles en el aspecto de la superficie y los motivos dentro de un mismo lote de producción / заметные отличия вида поверхности и графики в одной и той же партии

DESTINAZIONE D'USO / INTENDED USE / ANWENDUNGSBEREICH / CHAMP D'APPLICATION / USO PREVISTO / НАЗНАЧЕНИЕ

**H (Bianco, Marrone, Grigio: Naturale/Matt)**

Materiali consigliati per sollecitazioni all'abrasione relativamente forti in ambienti anche non protetti da agenti graffianti / Materials recommended for relatively heavy abrasion levels, also in premises not protected against abrasive substances / Materials recommended for relatively heavy abrasion levels, also in premises not protected against abrasive substances / Empfohlen für starke Abriebbeanspruchungen in Bereichen auch ohne Kratzschutzbehandlung / Matériaux recommandés pour des locaux soumis à des fortes contraintes d'abrasion, même non protégés contre les agents abrasifs / Materiales recomendados para soportar esfuerzos de abrasión relativamente intensos incluso en espacios no protegidos frente a agentes abrasivos / Материалы рекомендованы для относительно сильного абразивного воздействия, в том числе в помещениях, не защищенных от царапающих элементов

**G (Beige, Tortora: Naturale/Matt)**

Materiali consigliati per locali sottoposti a sollecitazioni all'abrasione medio pesanti come: case individuali, commerciale leggero / Materials recommended for premises with medium-heavy abrasion levels, such as: detached homes, light-traffic commercial premises / Empfohlen für Räume mit mittelschwerer Abriebbeanspruchung wie: Einfamilienhäuser, leicht beanspruchte Gewerbebereiche / Matériaux recommandés pour des locaux soumis à des contraintes d'abrasion moyennes et fortes comme : maisons particulières, espaces commerciaux soumis à un trafic léger, etc / Materiales recomendados para locales sometidos a esfuerzos de abrasión medio-pesados, como casas unifamiliares y locales comerciales de tráfico ligero / Материалы рекомендованы для использования в частных домах и коммерческих помещениях, подверженных средне-сильному абразивному воздействию

PEZZI SPECIALI / TRIMS / SPEZIALTEILE / PIÈCES SPÉCIALES / PIEZAS ESPECIALES / СПЕЦИАЛЬНЫЕ ИЗДЕЛИЯ

**BT.B.C.**

Battiscopa Becco Civetta ottenuto da taglio del fondo / Coved Edge Skirting Tile cut from plain tile / Sockelleiste, Halbrundstab, aus Grundfliese geschnitten / Plinthe bord rond découpée dans le fond / Rodapié canto romo conseguido mediante corte del fondo / Плинтус с закругленным краем, полученный из фоновой плитки

Ogni scatola contiene 5 pz del formato 10x100 e 5 pz del formato 13x100 da posare insieme / Each box contains 5 pcs of the 10x100 cm and 5 pcs of the 13x100 cm sizes, for installation together / Jeder Karton enthält 5 Stück im Format 10x100 cm und 5 Stück im Format 13x100 cm, die im Mix verlegt werden / Chaque boîte contient 5 pièces au format 10x100 cm et 5 pièces au format 13x100 cm à poser ensemble / Cada una de las cajas contiene cinco piezas de 10 x 100 cm y otras cinco de 13 x 100 cm que colocar combinadas / Каждая коробка содержит в себе 5 изделий в формате 10x100 см и 5 изделий в формате 13x100 см, предназначенных для совместной укладки

CARATTERISTICHE / CHARACTERISTICS / EIGENSCHAFTEN / CARACTERISTIQUES / DATOS / ХАРАКТЕРИСТИКИ

	<b>R9</b>	<b>PENDULUM classe 1</b>	<b>D-COF &gt; 0,42</b>	<b>BCR μ &gt; 0,40</b>
	<b>≤ 175 mm<sup>2</sup></b>			

CERTIFICAZIONI / CERTIFICATIONS / ZERTIFIZIERUNGEN / CERTIFICATIONS / CERTIFICACIONES / СЕРТИФИКАЦИИ



IMBALLI / PACKAGING / VERPACKUNGEN / EMBALLAGES / EMBALAJES / УПАКОВКИ

		scatole / box / karton / boîte / caja / короб			pallet / pallet / palette / palette / pallet / поддон			
			<b>M<sup>2</sup></b>	<b>KG</b>		<b>M<sup>2</sup></b>	<b>KG</b>	<b>±mm</b>
10x100 / 13x100		10	1,15	24,50	60	69,00	1470,00	9
5x100	BT.B.C.	10	10 ml	12,29	-	-	-	9

WOOD EFFECT

# Woodreal



R559 Woodreal Beige 10x100 / 13x100 - 3<sup>15/16</sup>"x39<sup>3/8</sup>" / 5<sup>1/8</sup>"x39<sup>3/8</sup>" - R6MQ A\_Mano Decoro Mix Crema 20x20 - 7<sup>7/8</sup>"x7<sup>7/8</sup>"



## Woodreal

gres porcellanato / porcelain stoneware / feinsteinzeug / grès cérame émaillé / gres porcelánico / керамогранит  
gruppo BIa UNI EN 14411\_G



10x100 cm  
3<sup>15/16</sup>"x39<sup>3/8</sup>"  
± 9 mm

13x100 cm  
5<sup>1/8</sup>"x39<sup>3/8</sup>"  
± 9 mm

# Woodreal

10x100 - 3<sup>15</sup>/<sub>16</sub>" x 39<sup>3</sup>/<sub>8</sub>" 13x100 - 5<sup>1</sup>/<sub>8</sub>" x 39<sup>3</sup>/<sub>8</sub>"

Bianco



R558 10x100 / 13x100



R5YH 5x100 BT.B.C.

Marrone



R55C 10x100 / 13x100



R5YM 5x100 BT.B.C.

Beige



R559 10x100 / 13x100



R5YJ 5x100 BT.B.C.

Tortora

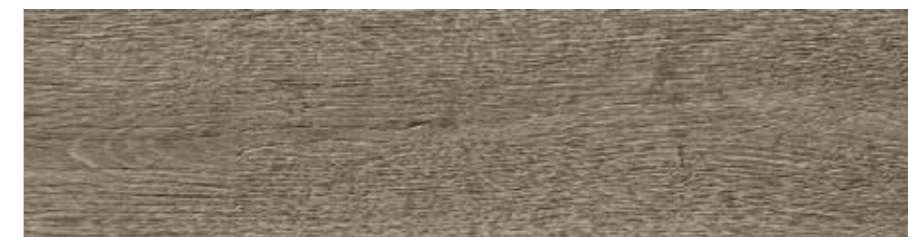

R55D 10x100 / 13x100



R5YN 5x100 BT.B.C.

Caramello



R55A 10x100 / 13x100



R5YK 5x100 BT.B.C.



R558 Bianco 10x100 / 13x100 - 3<sup>15/16</sup>"x39<sup>3/8</sup>" / 5<sup>1/8</sup>"x39<sup>3/8</sup>"

TECH INFO

VARIAZIONI CROMATICHE / COLOUR VARIATIONS / FARBVARIATIONEN / VARIATIONS CHROMATIQUES / VARIACIONES CROMÁTICAS / ВАРИАНТЫ ОТТЕНКА



V2

Apprezzabili differenze nell'aspetto di superficie e grafica all'interno della stessa produzione / Clearly distinguishable differences in texture and pattern within the same production run / Auffällige Unterschiede in Aussehen und Struktur innerhalb der gleichen Produktionscharge / Différences visibles au niveau de l'aspect et de la fantaisie entre les carreaux du même lot de production / Diferencias visibles en el aspecto de la superficie y los motivos dentro de un mismo lote de producción / заметные отличия вида поверхности и графики в одной и той же партии

DESTINAZIONE D'USO / INTENDED USE / ANWENDUNGSBEREICH / CHAMP D'APPLICATION / USO PREVISTO / НАЗНАЧЕНИЕ

H (Beige, Tortora: Naturale/Matt)

Materiali consigliati per sollecitazioni all'abrasione relativamente forti in ambienti anche non protetti da agenti graffianti / Materials recommended for relatively heavy abrasion levels, also in premises not protected against abrasive substances / Materials recommended for relatively heavy abrasion levels, also in premises not protected against abrasive substances / Empfohlen für starke Abriebbeanspruchungen in Bereichen auch ohne Kratzschutzbehandlung / Matériaux recommandés pour des locaux soumis à des fortes contraintes d'abrasion, même non protégés contre les agents abrasifs / Materiales recomendados para soportar esfuerzos de abrasión relativamente intensos incluso en espacios no protegidos frente a agentes abrasivos / Материалы рекомендованы для относительно сильного абразивного воздействия, в том числе в помещениях, не защищенных от царапающих элементов

G (Bianco, Caramello, Marrone: Naturale/Matt)

Materiali consigliati per locali sottoposti a sollecitazioni all'abrasione medio pesanti come: case individuali, commerciale leggero / Materials recommended for premises with medium-heavy abrasion levels, such as: detached homes, light-traffic commercial premises / Empfohlen für Räume mit mittelschwerer Abriebbeanspruchung wie: Einfamilienhäuser, leicht beanspruchte Gewerbebereiche / Matériaux recommandés pour des locaux soumis à des contraintes d'abrasion moyennes et fortes comme : maisons particulières, espaces commerciaux soumis à un trafic léger, etc / Materiales recomendados para locales sometidos a esfuerzos de abrasión medio-pesados, como casas unifamiliares y locales comerciales de tráfico ligero / Материалы рекомендованы для использования в частных домах и коммерческих помещениях, подверженных средне-сильному абразивному воздействию

PEZZI SPECIALI / TRIMS / SPEZIALTEILE / PIÈCES SPÉCIALES / PIEZAS ESPECIALES / СПЕЦИАЛЬНЫЕ ИЗДЕЛИЯ

BT.B.C.

Battiscopa Becco Civetta ottenuto da taglio del fondo / Coved Edge Skirting Tile cut from plain tile / Sockelleiste, Halbrundstab, aus Grundfliese geschnitten / Plinthe bord rond découpée dans le fond / Rodapié canto romo conseguido mediante corte del fondo / Плинтус с закругленным краем, полученный из фоновой плитки

Ogni scatola contiene 5 pz del formato 10x100 e 5 pz del formato 13x100 da posare insieme / Each box contains 5 pcs of the 10x100 cm and 5 pcs of the 13x100 cm sizes, for installation together / Jeder Karton enthält 5 Stück im Format 10x100 cm und 5 Stück im Format 13x100 cm, die im Mix verlegt werden / Chaque boîte contient 5 pièces au format 10x100 cm et 5 pièces au format 13x100 cm à poser ensemble / Cada una de las cajas contiene cinco piezas de 10 x 100 cm y otras cinco de 13 x 100 cm que colocar combinadas / Каждая коробка содержит в себе 5 изделий в формате 10x100 см и 5 изделий в формате 13x100 см, предназначенных для совместной укладки

CARATTERISTICHE / CHARACTERISTICS / EIGENSCHAFTEN / CARACTERISTIQUES / DATOS / ХАРАКТЕРИСТИКИ

	R9	PENDULUM classe 1	D-COF > 0,42	BCR μ > 0,40
	≤ 175 mm <sup>2</sup>			

CERTIFICAZIONI / CERTIFICATIONS / ZERTIFIZIERUNGEN / CERTIFICATIONS / CERTIFICACIONES / СЕРТИФИКАЦИИ



IMBALLI / PACKAGING / VERPACKUNGEN / EMBALLAGES / EMBALAJES / УПАКОВКИ

		scatole / box / karton / boîte / caja / короб			pallet / pallet / palette / palette / pallet / поддон			
		□	M <sup>2</sup>	KG	□	M <sup>2</sup>	KG	± mm
10x100 / 13x100		10	1,15	24,50	60	69,00	1470,00	9
5x100	BT.B.C.	10	10,00 ml	12,29	-	-	-	9

WOOD EFFECT

# Woodshape



R5RD Bianco 15x90 - 5<sup>7/8</sup> x 35<sup>7/16</sup>"



## Woodshape

gres porcellanato / porcelain stoneware / feinsteinzeug / grès cérame émaillé / gres porcelánico / керамогранит  
gruppo BIa UNI EN 14411\_G



15x90 cm  
5<sup>7/8</sup> x 35<sup>7/16</sup>"  
± 8 mm

# Woodshape

## Bianco



R5RD 15x90

15x90 - 5<sup>th</sup> x 35<sup>th</sup> 1/4"



R5RL 7,5x90 BT.B.C.

## Beige



R5RE 15x90  
R5RH 15x90 Grip



R5RM 7,5x90 BT.B.C.

## Marrone



R5RF 15x90  
R5RJ 15x90 Grip



R5RN 7,5x90 BT.B.C.

## Grigio



R5RG 15x90  
R5RK 15x90 Grip



R5RP 7,5x90 BT.B.C.

## TECH INFO

VARIAZIONI CROMATICHE / COLOUR VARIATIONS / FARBVARIATIONEN / VARIATIONS CHROMATIQUES / VARIACIONES CROMÁTICAS / ВАРИАНТЫ ОТТЕНКА



Significativa variazione di aspetto superficiale, grafica e colore da piastrella a piastrella e all'interno della stessa piastrella. Si consiglia di visionare la gamma cromatica prima della selezione del materiale / Significant variation in texture, pattern and colour from tile to tile within the same production run. The colour range should be viewed before selecting the material / Bedeutende Variation in Aussehen, Struktur und Farbe von Fliese zu Fliese und in ein und derselben Fliese. Es wird empfohlen, das Farbsortiment vor der Auswahl des Materials zu prüfen / Variation significative au niveau de l'aspect, de la fantaisie et de la couleur entre les carreaux et au sein d'un même carreau. Il est recommandé de consulter la gamme des couleurs avant de sélectionner le matériel / Variación considerable en el aspecto superficial, los motivos y el color entre un azulejo y otro y dentro del propio azulejo. Es aconsejable visualizar la gama cromática antes de seleccionar el material / Значительные отличия вида поверхности, графики и цвета у разных плиток и на одной и той же плитке. Перед отбором материала рекомендуется посмотреть цветовую гамму

DESTINAZIONE D'USO / INTENDED USE / ANWENDUNGSBEREICH / CHAMP D'APPLICATION / USO PREVISTO / НАЗНАЧЕНИЕ

### G (Naturale/Matt, Grip)

Materiali consigliati per locali sottoposti a sollecitazioni all'abrasione medio pesanti come: case individuali, commerciale leggero / Materials recommended for premises with medium-heavy abrasion levels, such as: detached homes, light-traffic commercial premises / Empfohlen für Räume mit mittelschwerer Abriebbeanspruchung wie: Einfamilienhäuser, leicht beanspruchte Gewerbebereiche / Matériaux recommandés pour des locaux soumis à des contraintes d'abrasion moyennes et fortes comme : maisons particulières, espaces commerciaux soumis à un trafic léger, etc / Materiales recomendados para locales sometidos a esfuerzos de abrasión medio-pesados, como casas unifamiliares y locales comerciales de tráfico ligero / Материалы рекомендованы для использования в частных домах и коммерческих помещениях, подверженных средне-сильному абразивному воздействию

PEZZI SPECIALI / TRIMS / SPEZIALTEILE / PIÈCES SPÉCIALES / PIEZAS ESPECIALES / СПЕЦИАЛЬНЫЕ ИЗДЕЛИЯ

### BT.B.C.

Battiscopa Becco Civetta ottenuto da taglio del fondo / Coved Edge Skirting Tile cut from plain tile / Sockelleiste, Halbrundstab, aus Grundfliese geschnitten / Plinthe bord rond découpée dans le fond / Rodapié canto romo conseguido mediante corte del fondo / Плинтус с закругленным краем, полученный из фоновой плитки

CARATTERISTICHE / CHARACTERISTICS / EIGENSCHAFTEN / CARACTERISTIQUES / DATOS / ХАРАКТЕРИСТИКИ

R10 R11 Grip	PENDULUM classe 2 classe 3 Grip	D-COF > 0,42	BCR μ > 0,40
C Grip			
	≤ 175 mm <sup>2</sup>		

CERTIFICAZIONI / CERTIFICATIONS / ZERTIFIZIERUNGEN / CERTIFICACIONES / СЕРТИФИКАЦИИ



IMBALLI / PACKAGING / VERPACKUNGEN / EMBALLAGES / EMBALAJES / УПАКОВКИ

		scatole / box / karton / boîte / caja / короб			pallet / pallet / palette / palette / pallet / поддон			
		□	M <sup>2</sup>	KG	□	M <sup>2</sup>	KG	± mm
15x90		8	1,08	19,35	48	51,84	928,80	8
15x90	Grip	8	1,08	19,35	48	51,84	928,80	8
7,5x90	BT.B.C.	15	13,50 ml	20,00	-	-	-	8

WOOD EFFECT

# Woodstory



R5QU Woodstory Tortora 15x90 - 5<sup>7/8</sup> x 35<sup>7/16</sup> - R6MP A\_Mano Vulcano 20x20 - 7<sup>7/8</sup> x 7<sup>7/8</sup> - R6NW A\_Mano Decoro Tappeto 2 Bianco Antico 20x20 - 7<sup>7/8</sup> x 7<sup>7/8</sup>



## Woodstory

gres porcellanato / porcelain stoneware / feinsteinzeug / grès cérame émaillé / gres porcelánico / керамогранит  
gruppo Bla UNI EN 14411\_G



naturale/  
matt outdoor



15x90 cm  
5<sup>7/8</sup> x 35<sup>7/16</sup>  
± 8 mm



# Woodstory

Bianco



R5QR 15x90



R5QW 7,5x90 BT.B.C.

Tortora



R5QU 15x90



R5RA 7,5x90 BT.B.C.

15x90 - 5<sup>th</sup> x35<sup>th</sup> 16"

Beige



R5QS 15x90  
R5RQ 15x90 Grip



R5QX 7,5x90 BT.B.C.

Grigio



R5QV 15x90  
R5RS 15x90 Grip



R5RC 7,5x90 BT.B.C.

Marrone



R5QT 15x90  
R5RR 15x90 Grip



R5QZ 7,5x90 BT.B.C.

# Woodstory



R50R Bianco 15x90 - 5<sup>th</sup> x35<sup>7/16</sup>

## TECH INFO

VARIAZIONI CROMATICHE / COLOUR VARIATIONS / FARBVARIATIONEN / VARIATIONS CHROMATIQUES / VARIACIONES CROMÁTICAS / ВАРИАНТЫ ОТТЕНКА



Significativa variazione di aspetto superficiale, grafica e colore da piastrella a piastrella e all'interno della stessa piastrella. Si consiglia di visionare la gamma cromatica prima della selezione del materiale / Significant variation in texture, pattern and colour from tile to tile within the same production run. The colour range should be viewed before selecting the material / Bedeutende Variation in Aussehen, Struktur und Farbe von Fliese zu Fliese und in ein und derselben Fliese. Es wird empfohlen, das Farbsortiment vor der Auswahl des Materials zu prüfen / Variation significative au niveau de l'aspect, de la fantaisie et de la couleur entre les carreaux et au sein d'un même carreau. Il est recommandé de consulter la gamme des couleurs avant de sélectionner le matériel / Variación considerable en el aspecto superficial, los motivos y el color entre un azulejo y otro y dentro del propio azulejo. Es aconsejable visualizar la gama cromática antes de seleccionar el material / Значительные отличия вида поверхности, графики и цвета у разных плиток и на одной и той же плитке. Перед отбором материала рекомендуется посмотреть цветовую гамму

DESTINAZIONE D'USO / INTENDED USE / ANWENDUNGSBEREICH / CHAMP D'APPLICATION / USO PREVISTO / НАЗНАЧЕНИЕ

### G (Naturale/Matt, Grip)

Materiali consigliati per locali sottoposti a sollecitazioni all'abrasione medio pesanti come: case individuali, commerciale leggero / Materials recommended for premises with medium-heavy abrasion levels, such as: detached homes, light-traffic commercial premises / Empfohlen für Räume mit mittelschwerer Abriebbeanspruchung wie: Einfamilienhäuser, leicht beanspruchte Gewerbebereiche / Matériaux recommandés pour des locaux soumis à des contraintes d'abrasion moyennes et fortes comme : maisons particulières, espaces commerciaux soumis à un trafic léger, etc / Materiales recomendados para locales sometidos a esfuerzos de abrasión medio-pesados, como casas unifamiliares y locales comerciales de tráfico ligero / Материалы рекомендованы для использования в частных домах и коммерческих помещениях, подверженных средне-сильному абразивному воздействию

CARATTERISTICHE / CHARACTERISTICS / EIGENSCHAFTEN / CARACTERISTIQUES / DATOS / ХАРАКТЕРИСТИКИ

R9 R11 Grip	PENDULUM classe 1 Naturale classe 3 Grip ptv > 36 Grip	D-COF > 0,42	BCR μ > 0,40
C Grip			
≤ 175 mm <sup>2</sup>			

CERTIFICAZIONI / CERTIFICATIONS / ZERTIFIZIERUNGEN / CERTIFICACIONES / СЕРТИФИКАЦИИ



IMBALLI / PACKAGING / VERPACKUNGEN / EMBALLAGES / EMBALAJES / УПАКОВКИ

	scatole / box / karton / boîte / caja / короб			pallet / pallet / palette / palette / pallet / поддон			
	□	M <sup>2</sup>	KG	□	M <sup>2</sup>	KG	± mm
15x90	8	1,08	19,35	48	51,84	928,80	8
15x90 Grip	8	1,08	19,35	48	51,84	928,80	8
7,5x90 BT.B.C.	15	13,50 ml	20,00	-	-	-	8

WOOD EFFECT

# Harmony



R2KH Beige 15x90 - 5<sup>th</sup> x35<sup>th</sup>/16<sup>th</sup>



## Harmony

gres porcellanato / porcelain stoneware / feinsteinzeug / grès cérame émaillé / gres porcelánico / керамогранит  
gruppo Bia UNI EN 14411\_G



naturale/  
matt outdoor



15x90 cm  
5<sup>7/8</sup> x35<sup>7/16</sup>  
± 8 mm

# Harmony

## Bianco



R2KF 15x90  
R2XJ 15x90 Grip



R2XP 7,5x90 BT.B.C.

## Beige



R2KH 15x90  
R2XK 15x90 Grip



R2XS 7,5x90 BT.B.C.

15x90 - 5<sup>th</sup> x35<sup>th</sup>16<sup>th</sup>

## Tortora



R2KG 15x90  
R2XL 15x90 Grip



R2XQ 7,5x90 BT.B.C.

## Marrone



R2KK 15x90  
R2XN 15x90 Grip



R2XT 7,5x90 BT.B.C.

## Miele



R2KJ 15x90  
R2XM 15x90 Grip



R2XR 7,5x90 BT.B.C.

# Harmony



R2KH Beige 15x90 - 5<sup>th</sup> x35<sup>th</sup>16

## TECH INFO

DESTINAZIONE D'USO / INTENDED USE / ANWENDUNGSBEREICH / CHAMP D'APPLICATION / USO PREVISTO / НАЗНАЧЕНИЕ

### H (Bianco, Miele: Naturale/Matt, Grip)

Materiali consigliati per sollecitazioni all'abrasione relativamente forti in ambienti anche non protetti da agenti graffianti / Materials recommended for relatively heavy abrasion levels, also in premises not protected against abrasive substances / Materials recommended for relatively heavy abrasion levels, also in premises not protected against abrasive substances / Empfohlen für starke Abriebbeanspruchungen in Bereichen auch ohne Kratzschutzbehandlung / Matériaux recommandés pour des locaux soumis à des fortes contraintes d'abrasion, même non protégés contre les agents abrasifs / Materiales recomendados para soportar esfuerzos de abrasión relativamente intensos incluso en espacios no protegidos frente a agentes abrasivos / Материалы рекомендованы для относительно сильного абразивного воздействия, в том числе в помещениях, не защищенных от царапающих элементов

### G (Beige, Tortora, Marrone: Naturale/Matt, Grip)

Materiali consigliati per locali sottoposti a sollecitazioni all'abrasione medio pesanti come: case individuali, commerciale leggero / Materials recommended for premises with medium-heavy abrasion levels, such as: detached homes, light-traffic commercial premises / Empfohlen für Räume mit mittelschwerer Abriebbeanspruchung wie: Einfamilienhäuser, leicht beanspruchte Gewerbebereiche / Matériaux recommandés pour des locaux soumis à des contraintes d'abrasion moyennes et fortes comme : maisons particulières, espaces commerciaux soumis à un trafic léger, etc / Materiales recomendados para locales sometidos a esfuerzos de abrasión medio-pesados, como casas unifamiliares y locales comerciales de tráfico ligero / Материалы рекомендованы для использования в частных домах и коммерческих помещениях, подверженных средне-сильному абразивному воздействию

PEZZI SPECIALI / TRIMS / SPEZIALTEILE / PIÈCES SPÉCIALES / PIEZAS ESPECIALES / СПЕЦИАЛЬНЫЕ ИЗДЕЛИЯ

### BT.B.C.

Battiscopa Becco Civetta ottenuto da taglio del fondo / Coved Edge Skirting Tile cut from plain tile / Sockelleiste, Halbrundstab, aus Grundfliese geschnitten / Plinthe bord rond découpée dans le fond / Rodapié canto romo conseguido mediante corte del fondo / Плинтус с закругленным краем, полученный из фоновой плитки

CONSIGLI DI POSA / INSTALLATION ADVICE / HINWEISE ZUR VERLEGUNG / CONSEILS DE POSE / SUGERENCIAS PARA LA COLOCACIÓN / РЕКОМЕНДАЦИИ ПО УКЛАДКЕ

Per le pavimentazioni esterne non protette, Ragno consiglia di creare una pendenza  $\geq 1,5\%$  sulla superficie calpestabile allo scopo di limitare il formarsi di ristagni d'acqua localizzati. Nel caso in cui questi ristagni permangano sulla superficie delle piastrelle nonostante una posa a regola d'arte, è necessario intervenire meccanicamente con l'utilizzo di scope o aspira-liquidi / For unprotected outdoor pavings, Ragno recommends the creation of a gradient of  $\geq 1,5\%$  on the finished surface, to prevent the formation of patches of standing water. In the event that standing water persists on the surface of the tiles in spite of correct installation, it must be removed mechanically with the aid of brooms or wet-and-dry vacuum cleaners / Zur Unterbindung von punktueller Stauwasserbildung bei Belägen in ungeschützten Außenbereichen, empfiehlt die Ragno die Ausbildung eines Gefälles  $\geq 1,5\%$  auf der Trittfäche. Sollte trotz fachgerechter Verlegung Stauwasser auf der Fliesenoberfläche zurückbleiben, ist dessen mechanische Entfernung mit Hilfe eines Besens oder Nasssaugers erforderlich / Pour des sols extérieurs non protégés, Ragno conseille de créer une inclinaison  $\geq 1,5\%$  sur la surface de piétinement en vue de limiter la stagnation localisée de l'eau. Si, malgré une pose dans les règles de l'art, cette stagnation devait persister à la surface des carreaux, une intervention mécanique, au moyen de balais et d'aspirateurs de liquides, est alors nécessaire / En el caso de pavimentaciones exteriores no protegidas, Ragno recomienda crear una pendiente  $\geq 1,5\%$  en la superficie transitabile para limitar la formación de depósitos localizados de agua estancada. En caso de que estos depósitos de agua permanezcan en la superficie del azulejo, aun cuando la colocación se haya realizado correctamente, será necesario intervenir mecánicamente empleando un cepillo o un aspirador de líquidos / Для наружных незащищенных полов Ragno рекомендует создавать уклон  $\geq 1,5\%$  на пешеходной поверхности для снижения образования локальных застоев воды. В случае, если застои воды образуются на плитке несмотря на правильную укладку, необходимо прибегать к использованию механических средств, таких как щетки или же аппараты для сбора жидкостей

CARATTERISTICHE / CHARACTERISTICS / EIGENSCHAFTEN / CARACTERISTIQUES / DATOS / ХАРАКТЕРИСТИКИ

	<b>R9</b> R10 Grip	<b>PENDULUM</b> classe 1 Naturale classe 3 Grip ptv $> 36$ Grip	<b>BCR</b> $\mu > 0,40$
	<b>B</b> Grip		
	$\leq 175$ mm <sup>2</sup>		

CERTIFICAZIONI / CERTIFICATIONS / ZERTIFIZIERUNGEN / CERTIFICACIONES / СЕРТИФИКАЦИИ



IMBALLI / PACKAGING / VERPACKUNGEN / EMBALLAJES / УПАКОВКИ

		scatole / box / karton / boîte / caja / короб			pallet / pallet / palette / palette / pallet / поддон			
		□	M <sup>2</sup>	KG	□	M <sup>2</sup>	KG	± mm
15x90		8	1,08	19,35	48	51,84	928,80	8
15x90	Grip	8	1,08	19,35	48	51,84	928,80	8
7,5x90	BT.B.C.	15	13,50 ml	24,10	-	-	-	8

WOOD EFFECT

# Woodcomfort



R3TV Acero 15x90 - 5<sup>7/16</sup> x35<sup>7/16</sup>



## Woodcomfort

gres porcellanato / porcelain stoneware / feinsteinzeug / grès cérame émaillé / gres porcelánico / керамогранит  
gruppo BIa UNI EN 14411\_6



naturale/  
matt



15x90 cm  
5<sup>7/16</sup> x35<sup>7/16</sup>  
± 8 mm

# Woodcomfort

15x90 - 5<sup>16</sup> x35<sup>116</sup>

Faggio



R3TT 15x90



R3TX 7,5x90 BT.B.C.

Ulivo



R3TU 15x90



R3TY 7,5x90 BT.B.C.

Acero



R3TV 15x90



R3TZ 7,5x90 BT.B.C.

Noce



R3TW 15x90



R3UA 7,5x90 BT.B.C.



# Woodcomfort



R3TT Faggio 15x90 - 5<sup>th</sup> x35<sup>th</sup>16

## TECH INFO

VARIAZIONI CROMATICHE / COLOUR VARIATIONS / FARBVARIATIONEN / VARIATIONS CHROMATIQUES / VARIACIONES CROMÁTICAS / ВАРИАНТЫ ОТТЕНКА



Significativa variazione di aspetto superficiale, grafica e colore da piastrella a piastrella e all'interno della stessa piastrella. Si consiglia di visionare la gamma cromatica prima della selezione del materiale / Significant variation in texture, pattern and colour from tile to tile within the same production run. The colour range should be viewed before selecting the material / Bedeutende Variation in Aussehen, Struktur und Farbe von Fliese zu Fliese und in ein und derselben Fliese. Es wird empfohlen, das Farbsortiment vor der Auswahl des Materials zu prüfen / Variation significative au niveau de l'aspect, de la fantaisie et de la couleur entre les carreaux et au sein d'un même carreau. Il est recommandé de consulter la gamme des couleurs avant de sélectionner le matériel / Variación considerable en el aspecto superficial, los motivos y el color entre un azulejo y otro y dentro del propio azulejo. Es aconsejable visualizar la gama cromática antes de seleccionar el material / Значительные отличия вида поверхности, графики и цвета у разных плиток и на одной и той же плитке. Перед отбором материала рекомендуется просмотреть цветовую гамму

DESTINAZIONE D'USO / INTENDED USE / ANWENDUNGSBEREICH / CHAMP D'APPLICATION / USO PREVISTO / НАЗНАЧЕНИЕ

### G (Naturale/Matt)

Materiali consigliati per locali sottoposti a sollecitazioni all'abrasione medio pesanti come: case individuali, commerciale leggero / Materials recommended for premises with medium-heavy abrasion levels, such as: detached homes, light-traffic commercial premises / Empfohlen für Räume mit mittelschwerer Abriebbeanspruchung wie: Einfamilienhäuser, leicht beanspruchte Gewerbebereiche / Matériaux recommandés pour des locaux soumis à des contraintes d'abrasion moyennes et fortes comme : maisons particulières, espaces commerciaux soumis à un trafic léger, etc / Materiales recomendados para locales sometidos a esfuerzos de abrasión medio-pesados, como casas unifamiliares y locales comerciales de tráfico ligero / Материалы рекомендованы для использования в частных домах и коммерческих помещениях, подверженных средне-сильному абразивному воздействию

PEZZI SPECIALI / TRIMS / SPEZIALTEILE / PIÈCES SPÉCIALES / PIEZAS ESPECIALES / СПЕЦИАЛЬНЫЕ ИЗДЕЛИЯ

### BT.B.C.

Battiscopa Becco Civetta ottenuto da taglio del fondo / Coved Edge Skirting Tile cut from plain tile / Sockelleiste, Halbrundstab, aus Grundfliese geschnitten / Plinthe bord rond découpée dans le fond / Rodapié canto romo conseguido mediante corte del fondo / Плинтус с закругленным краем, полученный из фоновой плитки

CARATTERISTICHE / CHARACTERISTICS / EIGENSCHAFTEN / CARACTERISTIQUES / DATOS / ХАРАКТЕРИСТИКИ

R9 PENDULUM classe 1

CERTIFICAZIONI / CERTIFICATIONS / ZERTIFIZIERUNGEN / CERTIFICATIONS / CERTIFICACIONES / СЕРТИФИКАЦИИ



IMBALLI / PACKAGING / VERPACKUNGEN / EMBALLAGES / EMBALAJES / УПАКОВКИ

		scatole / box / karton / boîte / caja / короб			pallet / pallet / palette / palette / pallet / поддон			
		□	M²	KG	□	M²	KG	±mm
15x90		8	1,08	19,35	48	51,84	928,80	8
7,5x90	BT.B.C.	15	13,50 ml	24,10	-	-	-	8



WOOD EFFECT

# Woodlike



R4WF Grey 15x90 - 5<sup>7/16</sup> x 35<sup>7/16</sup>"



## Woodlike

gres porcellanato / porcelain stoneware / feinsteinzeug / grès cérame émaillé / gres porcelánico / керамогранит  
gruppo BIa UNI EN 14411\_G



naturale/  
matt



15x90 cm  
5<sup>7/16</sup> x 35<sup>7/16</sup>"  
± 8 mm

# Woodlike

15x90 - 5<sup>1/8"</sup> x 35<sup>3/16"</sup>

## Gold



R4WC 15x90



R4WG 7,5x90 BT.B.C.

## Beige



R4WD 15x90



R4WH 7,5x90 BT.B.C.

## Walnut



R4WE 15x90



R4WJ 7,5x90 BT.B.C.

## Grey



R4WF 15x90



R4WK 7,5x90 BT.B.C.

## TECH INFO

VARIAZIONI CROMATICHE / COLOUR VARIATIONS / FARBVARIATIONEN / VARIATIONS CHROMATIQUES / VARIACIONES CROMÁTICAS / ВАРИАНТЫ ОТТЕНКА



Significativa variazione di aspetto superficiale, grafica e colore da piastrella a piastrella e all'interno della stessa piastrella. Si consiglia di visionare la gamma cromatica prima della selezione del materiale / Significant variation in texture, pattern and colour from tile to tile within the same production run. The colour range should be viewed before selecting the material / Bedeutende Variation in Aussehen, Struktur und Farbe von Fliese zu Fliese und in ein und derselben Fliese. Es wird empfohlen, das Farbsortiment vor der Auswahl des Materials zu prüfen / Variation significative au niveau de l'aspect, de la fantaisie et de la couleur entre les carreaux et au sein d'un même carreau. Il est recommandé de consulter la gamme des couleurs avant de sélectionner le matériel / Variación considerable en el aspecto superficial, los motivos y el color entre un azulejo y otro y dentro del propio azulejo. Es aconsejable visualizar la gama cromática antes de seleccionar el material / Значительные отличия вида поверхности, графики и цвета у разных плиток и на одной и той же плитке. Перед отбором материала рекомендуется посмотреть цветовую гамму

DESTINAZIONE D'USO / INTENDED USE / ANWENDUNGSBEREICH / CHAMP D'APPLICATION / USO PREVISTO / НАЗНАЧЕНИЕ

### H (Gold, Beige, Walnut: Naturale/Matt)

Materiali consigliati per sollecitazioni all'abrasione relativamente forti in ambienti anche non protetti da agenti graffianti / Materials recommended for relatively heavy abrasion levels, also in premises not protected against abrasive substances / Materials recommended for relatively heavy abrasion levels, also in premises not protected against abrasive substances / Empfohlen für starke Abriebbeanspruchungen in Bereichen auch ohne Kratzschutzbehandlung / Matériaux recommandés pour des locaux soumis à des fortes contraintes d'abrasion, même non protégés contre les agents abrasifs / Materiales recomendados para soportar esfuerzos de abrasión relativamente intensos incluso en espacios no protegidos frente a agentes abrasivos / Материалы рекомендованы для относительно сильного абразивного воздействия, в том числе в помещениях, не защищенных от царапающих элементов

### G (Grey: Naturale/Matt)

Materiali consigliati per locali sottoposti a sollecitazioni all'abrasione medio pesanti come: case individuali, commerciale leggero / Materials recommended for premises with medium-heavy abrasion levels, such as: detached homes, light-traffic commercial premises / Empfohlen für Räume mit mittelschwerer Abriebbeanspruchung wie: Einfamilienhäuser, leicht beanspruchte Gewerbebereiche / Matériaux recommandés pour des locaux soumis à des contraintes d'abrasion moyennes et fortes comme : maisons particulières, espaces commerciaux soumis à un trafic léger, etc / Materiales recomendados para locales sometidos a esfuerzos de abrasión medio-pesados, como casas unifamiliares y locales comerciales de tráfico ligero / Материалы рекомендованы для использования в частных домах и коммерческих помещениях, подверженных средне-сильному абразивному воздействию

PEZZI SPECIALI / TRIMS / SPEZIALTEILE / PIÈCES SPÉCIALES / PIEZAS ESPECIALES / СПЕЦИАЛЬНЫЕ ИЗДЕЛИЯ

### BT.B.C.

Battiscopa Becco Civetta ottenuto da taglio del fondo / Coved Edge Skirting Tile cut from plain tile / Sockelleiste, Halbrundstab, aus Grundfliese geschnitten / Plinthe bord rond découpée dans le fond / Rodapié canto romo conseguido mediante corte del fondo / Плинтус с закругленным краем, полученный из фоновой плитки

CARATTERISTICHE / CHARACTERISTICS / EIGENSCHAFTEN / CARACTERISTIQUES / DATOS / ХАРАКТЕРИСТИКИ

R9	PENDULUM classe 2	D-COF > 0,42	BCR $\mu > 0,40$
----	-------------------	--------------	------------------

CERTIFICAZIONI / CERTIFICATIONS / ZERTIFIZIERUNGEN / CERTIFICATIONS / CERTIFICACIONES / СЕРТИФИКАЦИИ



IMBALLI / PACKAGING / VERPACKUNGEN / EMBALLAGES / EMBALAJES / УПАКОВКИ

		scatole / box / karton / boîte / caja / короб			pallet / pallet / palette / palette / pallet / поддон			
		M <sup>2</sup>	KG		M <sup>2</sup>	KG	+ mm	
15x90		8	1,08	19,35	48	51,84	928,80	8
7,5x90	BT.B.C.	15	13,50 ml	24,10	-	-	-	8

WOOD EFFECT

# Woodclass



R76V Beige Rettificato 14,5x90 - 5<sup>11/16</sup>"x35<sup>7/16</sup>"



## Woodclass

gres porcellanato - rettificato monocalibro / porcelain stoneware - rectified monocaliber / feinsteinzeug - rektifiziert, in einem werkmaß / grès cérame émaillé - rectifié monocalibre / gres porcelánico - rectificado monocalibre / керамогранит - ректифицированный монокалиберный

gruppo Bia UNI EN 14411\_6



naturale/  
matt

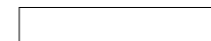

14,5x90 cm

5<sup>11/16</sup>"x35<sup>7/16</sup>"

± 8 mm

# Woodclass

White



R76U 14,5x90 Rett



R77C 7,2x90 BT.B.C.

Cherry



R76S 14,5x90 Rett



R76Z 7,2x90 BT.B.C.

Beige



R76V 14,5x90 Rett



R77D 7,2x90 BT.B.C.

Walnut



R76T 14,5x90 Rett



R77A 7,2x90 BT.B.C.

Honey



R76R 14,5x90 Rett



R76Y 7,2x90 BT.B.C.

14,5x90 - 5<sup>1/16</sup>"x35<sup>7/16</sup>"

# Woodclass

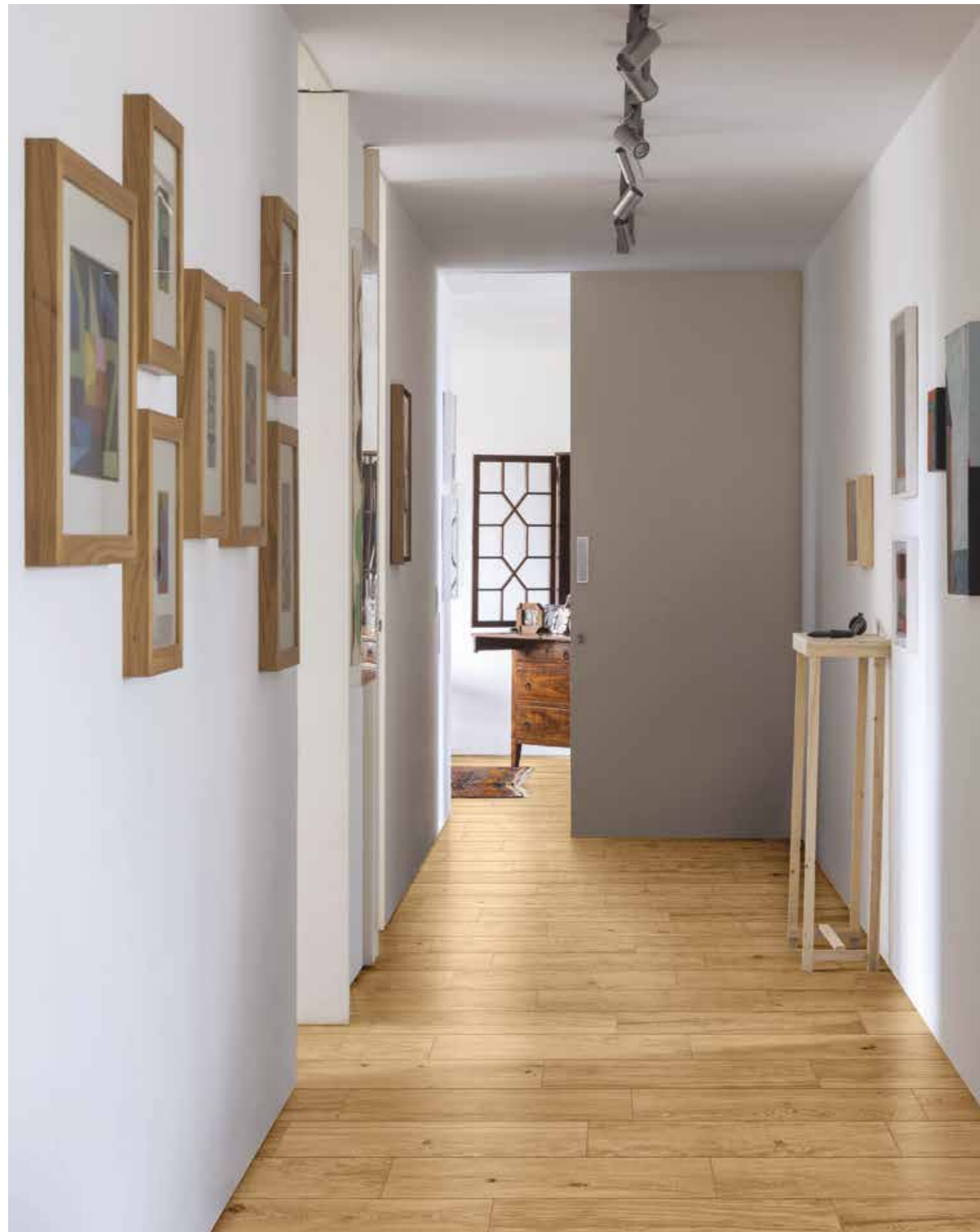

R76R Honey Rettificato 14,5x90 - 5<sup>1/16</sup>" x 35<sup>7/16</sup>"

## TECH INFO

VARIAZIONI CROMATICHE / COLOUR VARIATIONS / FARBVARIATIONEN / VARIATIONS CHROMATIQUES / VARIACIONES CROMÁTICAS / ВАРИАНТЫ ОТТЕНКА



V3

Significativa variazione di aspetto superficiale, grafica e colore da piastrella a piastrella e all'interno della stessa piastrella. Si consiglia di visionare la gamma cromatica prima della selezione del materiale / Significant variation in texture, pattern and colour from tile to tile within the same production run. The colour range should be viewed before selecting the material / Bedeutende Variation in Aussehen, Struktur und Farbe von Fliese zu Fliese und in ein und derselben Fliese. Es wird empfohlen, das Farbsortiment vor der Auswahl des Materials zu prüfen / Variation significative au niveau de l'aspect, de la fantaisie et de la couleur entre les carreaux et au sein d'un même carreau. Il est recommandé de consulter la gamme des couleurs avant de sélectionner le matériel / Variación considerable en el aspecto superficial, los motivos y el color entre un azulejo y otro y dentro del propio azulejo. Es aconsejable visualizar la gama cromática antes de seleccionar el material / Значительные отличия вида поверхности, графики и цвета у разных плиток и на одной и той же плитке. Перед отбором материала рекомендуется посмотреть цветовую гамму

DESTINAZIONE D'USO / INTENDED USE / ANWENDUNGSBEREICH / CHAMP D'APPLICATION / USO PREVISTO / НАЗНАЧЕНИЕ

### H (Naturale/Matt)

Materiali consigliati per sollecitazioni all'abrasione relativamente forti in ambienti anche non protetti da agenti graffianti / Materials recommended for relatively heavy abrasion levels, also in premises not protected against abrasive substances / Materials recommended for relatively heavy abrasion levels, also in premises not protected against abrasive substances / Empfohlen für starke Abriebbeanspruchungen in Bereichen auch ohne Kratzschutzbehandlung / Matériaux recommandés pour des locaux soumis à des fortes contraintes d'abrasion, même non protégés contre les agents abrasifs / Materiales recomendados para soportar esfuerzos de abrasión relativamente intensos incluso en espacios no protegidos frente a agentes abrasivos / Материалы рекомендованы для относительно сильного абразивного воздействия, в том числе в помещениях, не защищенных от царапающих элементов

CARATTERISTICHE / CHARACTERISTICS / EIGENSCHAFTEN / CARACTERISTIQUES / DATOS / ХАРАКТЕРИСТИКИ

R9	PENDULUM classe 1 Naturale	BCR μ > 0,40
----	-------------------------------	-----------------

CERTIFICAZIONI / CERTIFICATIONS / ZERTIFIZIERUNGEN / CERTIFICATIONS / CERTIFICACIONES / СЕРТИФИКАЦИИ



IMBALLI / PACKAGING / VERPACKUNGEN / EMBALLAGES / EMBALAJES / УПАКОВКИ

		scatole / box / karton / boîte / caja / короб			pallet / pallet / palette / palette / pallet / поддон			
		□	M <sup>2</sup>	KG	□	M <sup>2</sup>	KG	±mm
14,5x90	Rettificato	8	1,04	18,96	48	50,11	910,00	8
7,2x90	BT.B.C.	15	13,50 ml	17,64	-	-	-	8

WOOD EFFECT

# Woodpassion



R440 Smoke 15x90 - 5<sup>7/8</sup> x 35<sup>7/16</sup>"



## Woodpassion

14,5x90  
 gres porcellanato - rettificato monocalibro / porcelain stoneware - rectified monocaliber / feinsteinzeug - rektifiziert, in einem werkmaß / grès cérame émaillé - rectifié monocalibre / gres porcelánico - rectificado monocalibre / керамогранит - ректифицированный монокалиберный

15x90  
 gres porcellanato / porcelain stoneware / feinsteinzeug / grès cérame émaillé / gres porcelánico / керамогранит

gruppo Bla UNI EN 14411\_G



14,5x90 cm  
 5<sup>11/16</sup>" x 35<sup>7/16</sup>"  
 ± 8 mm

15x90 cm  
 5<sup>7/8</sup>" x 35<sup>7/16</sup>"  
 ± 8 mm

# Woodpassion

14,5x90 - 5<sup>11/16</sup>"x35<sup>7/16</sup>" 15x90 - 5<sup>7/8</sup>"x35<sup>7/16</sup>"

## Beige



R44L 15x90  
R1ZZ 14,5x90 Rett



R44R 7,5x90 BT.B.C.

## Ice



R44P 15x90  
R2EL 14,5x90 Rett



R44U 7,5x90 BT.B.C.

## Brown



R44M 15x90  
R21Z 14,5x90 Rett



R44S 7,5x90 BT.B.C.

## Smoke



R44Q 15x90  
R2EM 14,5x90 Rett



R44V 7,5x90 BT.B.C.

## Taupe



R44N 15x90  
R2AZ 14,5x90 Rett



R44T 7,5x90 BT.B.C.

# Woodpassion



R44M Brown 15x90 - 5<sup>th</sup> x35<sup>th</sup>16

## TECH INFO

VARIAZIONI CROMATICHE / COLOUR VARIATIONS / FARBVARIATIONEN / VARIATIONS CHROMATIQUES / VARIACIONES CROMÁTICAS / ВАРИАНТЫ ОТТЕНКА



Apprezzabili differenze nell'aspetto di superficie e grafica all'interno della stessa produzione / Clearly distinguishable differences in texture and pattern within the same production run / Auffällige Unterschiede in Aussehen und Struktur innerhalb der gleichen Produktionscharge / Différences visibles au niveau de l'aspect et de la fantaisie entre les carreaux du même lot de production / Diferencias visibles en el aspecto de la superficie y los motivos dentro de un mismo lote de producción / заметные отличия вида поверхности и графики в одной и той же партии

DESTINAZIONE D'USO / INTENDED USE / ANWENDUNGSBEREICH / CHAMP D'APPLICATION / USO PREVISTO / НАЗНАЧЕНИЕ

### G (Naturale/Matt)

Materiali consigliati per locali sottoposti a sollecitazioni all'abrasione medio pesanti come: case individuali, commerciale leggero / Materials recommended for premises with medium-heavy abrasion levels, such as: detached homes, light-traffic commercial premises / Empfohlen für Räume mit mittelschwerer Abriebbeanspruchung wie: Einfamilienhäuser, leicht beanspruchte Gewerbebereiche / Matériaux recommandés pour des locaux soumis à des contraintes d'abrasion moyennes et fortes comme : maisons particulières, espaces commerciaux soumis à un trafic léger, etc / Materiales recomendados para locales sometidos a esfuerzos de abrasión medio-pesados, como casas unifamiliares y locales comerciales de tráfico ligero / Материалы рекомендованы для использования в частных домах и коммерческих помещениях, подверженных средне-сильному абразивному воздействию

PEZZI SPECIALI / TRIMS / SPEZIALTEILE / PIÈCES SPÉCIALES / PIEZAS ESPECIALES / СПЕЦИАЛЬНЫЕ ИЗДЕЛИЯ

### BT.B.C.

Battiscopa Becco Civetta ottenuto da taglio del fondo / Coved Edge Skirting Tile cut from plain tile / Sockelleiste, Halbrundstab, aus Grundfliese geschnitten / Plinthe bord rond découpée dans le fond / Rodapié canto romo conseguido mediante corte del fondo / Плинтус с закругленным краем, полученный из фоновой плитки

CARATTERISTICHE / CHARACTERISTICS / EIGENSCHAFTEN / CARACTERISTIQUES / DATOS / ХАРАКТЕРИСТИКИ

R9	PENDULUM classe 2	BCR $\mu > 0,40$
$\leq 175 \text{ mm}^3$		

CERTIFICAZIONI / CERTIFICATIONS / ZERTIFIZIERUNGEN / CERTIFICATIONS / CERTIFICACIONES / СЕРТИФИКАЦИИ



IMBALLI / PACKAGING / VERPACKUNGEN / EMBALLAGES / EMBALAJES / УПАКОВКИ

	scatole / box / karton / boîte / caja / короб			pallet / pallet / palette / palette / pallet / поддон			
	□	M²	KG	□	M²	KG	± mm
15x90	8	1,08	19,35	48	51,84	928,80	8
14,5x90	8	1,04	18,96	48	50,11	910,00	8
7,5x90	15	13,50 ml	24,10	-	-	-	8



WOOD EFFECT

# Woodcraft



R4LW Grigio 10x70 - 3<sup>15/16</sup>"x27<sup>9/16</sup>"



## Woodcraft

gres porcellanato / porcelain stoneware / feinsteinzeug / grès cérame émaillé / gres porcelánico / керамогранит  
gruppo Bla UNI EN 14411\_6



10x70 cm

3<sup>15/16</sup>"x27<sup>9/16</sup>"

± 8 mm

# Woodcraft

Beige



R4LZ 10x70  
R520 10x70 Grip



R4ND 5x70 BT.B.C.

Antracite



R4LX 10x70



R4NA 5x70 BT.B.C.

10x70 - 3<sup>15/16</sup>" x 27<sup>11/16</sup>"

Marrone



R4LY 10x70



R4NC 5x70 BT.B.C.

Bianco



R4MA 10x70



R4NE 5x70 BT.B.C.

Grigio



R4LW 10x70  
R51Z 10x70 Grip



R4MZ 5x70 BT.B.C.



# Woodcraft

WOODCRAFT | WOOD EFFECT



R4LX Antracite 10x70 - 3<sup>19/16</sup> x 27<sup>9/16</sup>

## TECH INFO

VARIAZIONI CROMATICHE / COLOUR VARIATIONS / FARBVARIATIONEN / VARIATIONS CHROMATIQUES / VARIACIONES CROMÁTICAS / ВАРИАНТЫ ОТТЕНКА



Variazioni irregolari da piastrella a piastrella. Una piastrella può differire totalmente nell'aspetto superficiale e colore da un'altra. Si consiglia di visionare la gamma cromatica prima della selezione del materiale / Random differences from tile to tile. One tile may have totally different texture and colour from another. The colour range should be viewed before selecting the material / Wesentliche Variationen von Fliese zu Fliese. Eine Fliese kann sich in Aussehen und Farbe komplett von einer anderen unterscheiden. Es wird empfohlen, das Farbsortiment vor der Auswahl des Materials zu prüfen / Variations irrégulières entre les carreaux. L'aspect et la couleur peuvent être complètement différents d'un carreau à l'autre. Il est recommandé de consulter la gamme des couleurs avant de sélectionner le matériel / Variaciones irregulares entre un azulejo y otro. Un azulejo puede ser completamente diferente de otro en el aspecto superficial y el color. Es aconsejable visualizar la gama cromática antes de seleccionar el material / Неоднородные изменения на разных плитках. Каждая плитка может полностью отличаться по виду поверхности и цвету от другой. Перед отбором материала рекомендуется посмотреть цветовую гамму

DESTINAZIONE D'USO / INTENDED USE / ANWENDUNGSBEREICH / CHAMP D'APPLICATION / USO PREVISTO / НАЗНАЧЕНИЕ

### H (Beige, Bianco, Grigio, Antracite: Natural/Matt)

Materiali consigliati per sollecitazioni all'abrasione relativamente forti in ambienti anche non protetti da agenti graffianti / Materials recommended for relatively heavy abrasion levels, also in premises not protected against abrasive substances / Materials recommended for relatively heavy abrasion levels, also in premises not protected against abrasive substances / Empfohlen für starke Abriebbeanspruchungen in Bereichen auch ohne Kratzschutzbehandlung / Matériaux recommandés pour des locaux soumis à des fortes contraintes d'abrasion, même non protégés contre les agents abrasifs / Materiales recomendados para soportar esfuerzos de abrasión relativamente intensos incluso en espacios no protegidos frente a agentes abrasivos / Материалы рекомендованы для относительно сильного абразивного воздействия, в том числе в помещениях, не защищенных от царапающих элементов

### G (Marrone: Natural/Matt - Beige, Grigio: Grip)

Materiali consigliati per locali sottoposti a sollecitazioni all'abrasione medio pesanti come: case individuali, commerciale leggero / Materials recommended for premises with medium-heavy abrasion levels, such as: detached homes, light-traffic commercial premises / Empfohlen für Räume mit mittelschwerer Abriebbeanspruchung wie: Einfamilienhäuser, leicht beanspruchte Gewerbebereiche / Matériaux recommandés pour des locaux soumis à des contraintes d'abrasion moyennes et fortes comme : maisons particulières, espaces commerciaux soumis à un trafic léger, etc / Materiales recomendados para locales sometidos a esfuerzos de abrasión medio-pesados, como casas unifamiliares y locales comerciales de tráfico ligero / Материалы рекомендованы для использования в частных домах и коммерческих помещениях, подверженных средне-сильному абразивному воздействию

PEZZI SPECIALI / TRIMS / SPEZIALTEILE / PIÈCES SPÉCIALES / PIEZAS ESPECIALES / СПЕЦИАЛЬНЫЕ ИЗДЕЛИЯ

### BT.B.C.

Battiscopa Becco Civetta ottenuto da taglio del fondo / Coved Edge Skirting Tile cut from plain tile / Sockelleiste, Halbrundstab, aus Grundfliese geschnitten / Plinthe bord rond découpée dans le fond / Rodapié canto romo conseguido mediante corte del fondo / Плинтус с закругленным краем, полученный из фоновой плитки

Per le pavimentazioni esterne non protette, Ragno consiglia di creare una pendenza  $\geq 1,5\%$  sulla superficie calpestabile allo scopo di limitare il formarsi di ristagni d'acqua localizzati. Nel caso in cui questi ristagni permangano sulla superficie delle piastrelle nonostante una posa a regola d'arte, è necessario intervenire meccanicamente con l'utilizzo di scope o aspira-liquidi. / For unprotected outdoor pavings, Ragno recommends the creation of a gradient of  $\geq 1.5\%$  on the finished surface, to prevent the formation of patches of standing water. In the event that standing water persists on the surface of the tiles in spite of correct installation, it must be removed mechanically with the aid of brooms or wet-and-dry vacuum cleaners. / Zur Unterbindung von punktueller Stauwasserbildung bei Belägen in ungeschützten Außenbereichen, empfiehlt die Ragno die Ausbildung eines Gefälles  $\geq 1,5\%$  auf der Trittläche. Sollte trotz fachgerechter Verlegung Stauwasser auf der Fliesenoberfläche zurückbleiben, ist dessen mechanische Entfernung mit Hilfe eines Besens oder Nasssaugers erforderlich. / Pour des sols extérieurs non protégés, Ragno conseille de créer une inclinaison  $\geq 1,5\%$  sur la surface de piétinement en vue de limiter la stagnation localisée de l'eau. Si, malgré une pose dans les règles de l'art, cette stagnation devait persister à la surface des carreaux, une intervention mécanique, au moyen de balais et d'aspirateurs de liquides, est alors nécessaire. / En el caso de pavimentaciones exteriores no protegidas, Ragno recomienda crear una pendiente  $\geq 1,5\%$  en la superficie transitable para limitar la formación de depósitos localizados de agua estancada. En caso de que estos depósitos de agua permanezcan en la superficie del azulejo, aun cuando la colocación se haya realizado correctamente, será necesario intervenir mecánicamente empleando un cepillo o un aspirador de líquidos. / Для наружных незащищенных полов Ragno рекомендует создавать уклон  $\geq 1,5\%$  на пешеходной поверхности для снижения образования локальных застоев воды. В случае, если застои воды образуются на плитке несмотря на правильную укладку, необходимо прибегать к использованию механических средств, таких как щетки или же аппараты для сбора жидкостей.

WOODCRAFT | WOOD EFFECT

CARATTERISTICHE / CHARACTERISTICS / EIGENSCHAFTEN / CARACTERISTIQUES / DATOS / ХАРАКТЕРИСТИКИ

R9 Grip	PENDULUM classe 1 Naturale classe 3 Grip p <sub>tv</sub> > 36 Grip	D-COF > 0,42	BCR $\mu > 0,40$ Grip
B Grip			

CERTIFICAZIONI / CERTIFICATIONS / ZERTIFIZIERUNGEN / CERTIFICATIONS / CERTIFICACIONES / СЕРТИФИКАЦИИ



IMBALLI / PACKAGING / VERPACKUNGEN / EMBALLAGES / EMBALAJES / УПАКОВКИ

	scatole / box / karton / boîte / caja / короб			pallet / pallet / palette / palette / pallet / поддон			
	□	M²	KG	□	M²	KG	± mm
10x70	17	1,19	21,00	48	57,12	1008,00	8
10x70 Grip	17	1,19	21,00	48	57,12	1008,00	8
5x70 BT.B.C.	15	10,50 ml	12,76	-	-	-	8

WOOD EFFECT

# Woodessence



R4MF Honey 10x70 - 3<sup>15/16</sup>"x27<sup>9/16</sup>"



## Woodessence

gres porcellanato / porcelain stoneware / feinsteinzeug / grès cérame émaillé / gres porcelánico / керамогранит  
gruppo Bla UNI EN 14411\_G



10x70 cm  
3<sup>15/16</sup>"x27<sup>9/16</sup>"  
± 8 mm

# Woodessence

10x70 - 3<sup>15/16</sup>" x 27<sup>11/16</sup>"

Beige



R4MC 10x70



R4MU 5x70 BT.B.C.

Honey



R4MF 10x70



R4MX 5x70 BT.B.C.

Brown



R4ME 10x70



R4MW 5x70 BT.B.C.

Walnut



R4MG 10x70



R4MY 5x70 BT.B.C.

Grey



R4MD 10x70



R4MV 5x70 BT.B.C.

# Woodessence



R4ME Woodessence Brown 10x70 - 3<sup>15/16</sup>"x27<sup>9/16</sup>" - R4GK Brick Glossy Beige 10x30 - 3<sup>15/16</sup>"x11<sup>13/16</sup>"

## TECH INFO

VARIAZIONI CROMATICHE / COLOUR VARIATIONS / FARBVARIATIONEN / VARIATIONS CHROMATIQUES / VARIACIONES CROMÁTICAS / ВАРИАНТЫ ОТТЕНКА



V2

Apprezzabili differenze nell'aspetto di superficie e grafica all'interno della stessa produzione / Clearly distinguishable differences in texture and pattern within the same production run / Auffällige Unterschiede in Aussehen und Struktur innerhalb der gleichen Produktionscharge / Différences visibles au niveau de l'aspect et de la fantaisie entre les carreaux du même lot de production / Diferencias visibles en el aspecto de la superficie y los motivos dentro de un mismo lote de producción / заметные отличия вида поверхности и графики в одной и той же партии

DESTINAZIONE D'USO / INTENDED USE / ANWENDUNGSBEREICH / CHAMP D'APPLICATION / USO PREVISTO / НАЗНАЧЕНИЕ

### H (Beige, Brown, Grey, Honey: Naturale/Matt)

Materiali consigliati per sollecitazioni all'abrasione relativamente forti in ambienti anche non protetti da agenti graffianti / Materials recommended for relatively heavy abrasion levels, also in premises not protected against abrasive substances / Materials recommended for relatively heavy abrasion levels, also in premises not protected against abrasive substances / Empfohlen für starke Abriebbeanspruchungen in Bereichen auch ohne Kratzschutzbehandlung / Matériaux recommandés pour des locaux soumis à des fortes contraintes d'abrasion, même non protégés contre les agents abrasifs / Materiales recomendados para soportar esfuerzos de abrasión relativamente intensos incluso en espacios no protegidos frente a agentes abrasivos / Материалы рекомендованы для относительно сильного абразивного воздействия, в том числе в помещениях, не защищенных от царапающих элементов

### G (Walnut: Naturale/Matt)

Materiali consigliati per locali sottoposti a sollecitazioni all'abrasione medio pesanti come: case individuali, commerciale leggero / Materials recommended for premises with medium-heavy abrasion levels, such as: detached homes, light-traffic commercial premises / Empfohlen für Räume mit mittelschwerer Abriebbeanspruchung wie: Einfamilienhäuser, leicht beanspruchte Gewerbebereiche / Matériaux recommandés pour des locaux soumis à des contraintes d'abrasion moyennes et fortes comme : maisons particulières, espaces commerciaux soumis à un trafic léger, etc / Materiales recomendados para locales sometidos a esfuerzos de abrasión medio-pesados, como casas unifamiliares y locales comerciales de tráfico ligero / Материалы рекомендованы для использования в частных домах и коммерческих помещениях, подверженных средне-сильному абразивному воздействию

PEZZI SPECIALI / TRIMS / SPEZIALTEILE / PIÈCES SPÉCIALES / PIEZAS ESPECIALES / СПЕЦИАЛЬНЫЕ ИЗДЕЛИЯ

### BT.B.C.

Battiscopa Becco Civetta ottenuto da taglio del fondo / Coved Edge Skirting Tile cut from plain tile / Sockelleiste, Halbrundstab, aus Grundfliese geschnitten / Plinthe bord rond découpée dans le fond / Rodapié canto romo conseguido mediante corte del fondo / Плинтус с закругленным краем, полученный из фоновой плитки

CARATTERISTICHE / CHARACTERISTICS / EIGENSCHAFTEN / CARACTERISTIQUES / DATOS / ХАРАКТЕРИСТИКИ

R9	PENDULUM classe 1	D-COF > 0,42
----	----------------------	-----------------

CERTIFICAZIONI / CERTIFICATIONS / ZERTIFIZIERUNGEN / CERTIFICATIONS / CERTIFICACIONES / СЕРТИФИКАЦИИ



IMBALLI / PACKAGING / VERPACKUNGEN / EMBALLAGES / EMBALAJES / УПАКОВКИ

		scatole / box / karton / boîte / caja / короб			pallet / pallet / palette / palette / pallet / поддон			
		□	M²	KG	□	M²	KG	±mm
10x70		17	1,19	21,00	48	57,12	1008,00	8
5x70	BT.B.C.	15	10,50 ml	12,76	-	-	-	8

WOOD EFFECT

# Woodglam



R06P Naturale 10x70 - 3<sup>15/16</sup>"x27<sup>7/16</sup>"



## Woodglam

gres porcellanato / porcelain stoneware / feinsteinzeug / grès cérame émaillé / gres porcelánico / керамогранит  
gruppo Bia UNI EN 14411\_G



10x70 cm  
3<sup>15/16</sup>"x27<sup>7/16</sup>"  
± 8 mm

# Woodglam

## Naturale



R06P 10x70

10x70 - 3<sup>15/16</sup> x 27<sup>9/16</sup>"



R06T 5x70 BT.B.C.

## Tortora



R06Q 10x70



R06U 5x70 BT.B.C.

## Noce



R06R 10x70



R06V 5x70 BT.B.C.

## Grigio



R06N 10x70



R06S 5x70 BT.B.C.

## TECH INFO

VARIAZIONI CROMATICHE / COLOUR VARIATIONS / FARBVARIATIONEN / VARIATIONS CHROMATIQUES / VARIACIONES CROMÁTICAS / ВАРИАНТЫ ОТТЕНКА



Significativa variazione di aspetto superficiale, grafica e colore da piastrella a piastrella e all'interno della stessa piastrella. Si consiglia di visionare la gamma cromatica prima della selezione del materiale / Significant variation in texture, pattern and colour from tile to tile within the same production run. The colour range should be viewed before selecting the material / Bedeutende Variation in Aussehen, Struktur und Farbe von Fliese zu Fliese und in ein und derselben Fliese. Es wird empfohlen, das Farbsortiment vor der Auswahl des Materials zu prüfen / Variation significative au niveau de l'aspect, de la fantaisie et de la couleur entre les carreaux et au sein d'un même carreau. Il est recommandé de consulter la gamme des couleurs avant de sélectionner le matériel / Variación considerable en el aspecto superficial, los motivos y el color entre un azulejo y otro y dentro del propio azulejo. Es aconsejable visualizar la gama cromática antes de seleccionar el material / Значительные отличия вида поверхности, графики и цвета у разных плиток и на одной и той же плитке. Перед отбором материала рекомендуется посмотреть цветовую гамму

DESTINAZIONE D'USO / INTENDED USE / ANWENDUNGSBEREICH / CHAMP D'APPLICATION / USO PREVISTO / НАЗНАЧЕНИЕ

### H (Tortora, Noce, Grigio: Naturale/Matt)

Materiali consigliati per sollecitazioni all'abrasione relativamente forti in ambienti anche non protetti da agenti graffianti / Materials recommended for relatively heavy abrasion levels, also in premises not protected against abrasive substances / Materials recommended for relatively heavy abrasion levels, also in premises not protected against abrasive substances / Empfohlen für starke Abriebbeanspruchungen in Bereichen auch ohne Kratzschutzbehandlung / Matériaux recommandés pour des locaux soumis à des fortes contraintes d'abrasion, même non protégés contre les agents abrasifs / Materiales recomendados para soportar esfuerzos de abrasión relativamente intensos incluso en espacios no protegidos frente a agentes abrasivos / Материалы рекомендованы для относительно сильного абразивного воздействия, в том числе в помещениях, не защищенных от царапающих элементов

### G (Naturale: Naturale/Matt)

Materiali consigliati per locali sottoposti a sollecitazioni all'abrasione medio pesanti come: case individuali, commerciale leggero / Materials recommended for premises with medium-heavy abrasion levels, such as: detached homes, light-traffic commercial premises / Empfohlen für Räume mit mittelschwerer Abriebbeanspruchung wie: Einfamilienhäuser, leicht beanspruchte Gewerbebereiche / Matériaux recommandés pour des locaux soumis à des contraintes d'abrasion moyennes et fortes comme : maisons particulières, espaces commerciaux soumis à un trafic léger, etc / Materiales recomendados para locales sometidos a esfuerzos de abrasión medio-pesados, como casas unifamiliares y locales comerciales de tráfico ligero / Материалы рекомендованы для использования в частных домах и коммерческих помещениях, подверженных средне-сильному абразивному воздействию

PEZZI SPECIALI / TRIMS / SPEZIALTEILE / PIÈCES SPÉCIALES / PIEZAS ESPECIALES / СПЕЦИАЛЬНЫЕ ИЗДЕЛИЯ

### BT.B.C.

Battiscopa Becco Civetta ottenuto da taglio del fondo / Coved Edge Skirting Tile cut from plain tile / Sockelleiste, Halbrundstab, aus Grundfliese geschnitten / Plinthe bord rond découpée dans le fond / Rodapié canto romo conseguido mediante corte del fondo / Плинтус с закругленным краем, полученный из фоновой плитки

CARATTERISTICHE / CHARACTERISTICS / EIGENSCHAFTEN / CARACTERISTIQUES / DATOS / ХАРАКТЕРИСТИКИ

R9	PENDULUM classe 1	D-COF > 0,42	BCR μ > 0,40
----	----------------------	-----------------	-----------------

CERTIFICAZIONI / CERTIFICATIONS / ZERTIFIZIERUNGEN / CERTIFICATIONS / CERTIFICACIONES / СЕРТИФИКАЦИИ



IMBALLI / PACKAGING / VERPACKUNGEN / EMBALLAGES / EMBALAJES / УПАКОВКИ

		scatole / box / karton / boîte / caja / короб			pallet / pallet / palette / palette / pallet / поддон			
		□	M <sup>2</sup>	KG	□	M <sup>2</sup>	KG	±mm
10x70		17	1,19	21,00	48	57,12	1008,00	8
5x70	BT.B.C.	15	10,50 ml	12,76	-	-	-	8



WOOD EFFECT

# Woodchoice



R17K Chevron Coconut 11x54 - 4<sup>5/16</sup>" x 21<sup>1/4</sup>"



## Woodchoice

gres porcellanato / porcelain stoneware / feinsteinzeug / grès cérame émaillé / gres porcelánico / керамогранит  
gruppo Bla UNI EN 14411\_G



naturale/  
matt



11x54 cm  
4<sup>5/16</sup>" x 21<sup>1/4</sup>"  
± 9 mm

# Woodchoice

Chevron Milk



R17H 11x54



R6MU 7,5x60 BT.B.C.

Chevron Tea



R17L 11x54



R6MY 7,5x60 BT.B.C.

11x54 - 4<sup>5/16</sup> x 21<sup>1/4</sup>"

Chevron Sugar



R17J 11x54



R6MV 7,5x60 BT.B.C.

Chevron Salt



R17M 11x54



R6MW 7,5x60 BT.B.C.

Chevron Coconut



R17K 11x54



R6MX 7,5x60 BT.B.C.

# Woodchoice



R71H Chevron Milk 11x54 - 4<sup>5/16</sup>"x21<sup>1/4</sup>"

## TECH INFO

VARIAZIONI CROMATICHE / COLOUR VARIATIONS / FARBVARIATIONEN / VARIATIONS CHROMATIQUES / VARIACIONES CROMÁTICAS / ВАРИАНТЫ ОТТЕНКА



V3

Significativa variazione di aspetto superficiale, grafica e colore da piastrella a piastrella e all'interno della stessa piastrella. Si consiglia di visionare la gamma cromatica prima della selezione del materiale / Significant variation in texture, pattern and colour from tile to tile within the same production run. The colour range should be viewed before selecting the material / Bedeutende Variation in Aussehen, Struktur und Farbe von Fliese zu Fliese und in ein und derselben Fliese. Es wird empfohlen, das Farbsortiment vor der Auswahl des Materials zu prüfen / Variation significative au niveau de l'aspect, de la fantaisie et de la couleur entre les carreaux et au sein d'un même carreau. Il est recommandé de consulter la gamme des couleurs avant de sélectionner le matériel / Variación considerable en el aspecto superficial, los motivos y el color entre un azulejo y otro y dentro del propio azulejo. Es aconsejable visualizar la gama cromática antes de seleccionar el material / Значительные отличия вида поверхности, графики и цвета у разных плиток и на одной и той же плитке. Перед отбором материала рекомендуется посмотреть цветовую гамму

DESTINAZIONE D'USO / INTENDED USE / ANWENDUNGSBEREICH / CHAMP D'APPLICATION / USO PREVISTO / НАЗНАЧЕНИЕ

### G (Naturale/Matt)

Materiali consigliati per locali sottoposti a sollecitazioni all'abrasione medio pesanti come: case individuali, commerciale leggero / Materials recommended for premises with medium-heavy abrasion levels, such as: detached homes, light-traffic commercial premises / Empfohlen für Räume mit mittelschwerer Abriebbeanspruchung wie: Einfamilienhäuser, leicht beanspruchte Gewerbebereiche / Matériaux recommandés pour des locaux soumis à des contraintes d'abrasion moyennes et fortes comme : maisons particulières, espaces commerciaux soumis à un trafic léger, etc / Materiales recomendados para locales sometidos a esfuerzos de abrasión medio-pesados, como casas unifamiliares y locales comerciales de tráfico ligero / Материалы рекомендованы для использования в частных домах и коммерческих помещениях, подверженных средне-сильному абразивному воздействию

PEZZI SPECIALI / TRIMS / SPEZIALTEILE / PIÈCES SPÉCIALES / PIEZAS ESPECIALES / СПЕЦИАЛЬНЫЕ ИЗДЕЛИЯ

### BT.B.C.

Battiscopa Becco Civetta ottenuto da taglio del fondo / Coved Edge Skirting Tile cut from plain tile / Sockelleiste, Halbrundstab, aus Grundfliese geschnitten / Plinthe bord rond découpée dans le fond / Rodapié canto romo conseguido mediante corte del fondo / Плинтус с закругленным краем, полученный из фоновой плитки

CARATTERISTICHE / CHARACTERISTICS / EIGENSCHAFTEN / CARACTERISTIQUES / DATOS / ХАРАКТЕРИСТИКИ

R9	PENDULUM classe 1	D-COF > 0,42	BCR μ > 0,40
----	----------------------	-----------------	-----------------

CERTIFICAZIONI / CERTIFICATIONS / ZERTIFIZIERUNGEN / CERTIFICATIONS / CERTIFICACIONES / СЕРТИФИКАЦИИ



IMBALLI / PACKAGING / VERPACKUNGEN / EMBALLAGES / EMBALAJES / УПАКОВКИ

	scatole / box / karton / boîte / caja / короб			pallet / pallet / palette / palette / pallet / поддон			
	□	M²	KG	□	M²	KG	±mm
11x54	18	0,94	18,09	45	42,44	813,88	9
7,5x60	16	9,60	14,40	-	-	-	8,5

# XT20



- 390 Realstone\_Lunar XT20
- 396 Realstone\_Navigli XT20
- 400 Realstone\_PietrAntica XT20
- 406 Realstone\_Slate XT20
- 410 Realstone\_Rain XT20
- 414 Realstone\_Cardoso XT20
- 418 Realstone\_Jerusalem XT20
- 422 Realstone\_Quarzite XT20
- 426 Stoneway\_Ardesia XT20
- 430 Stoneway\_Barge Antica XT20
- 434 Stoneway\_Porfido XT20
- 438 Woodsense XT20
- 442 Woodliving XT20
- 446 Woodtale XT20
- 450 Woodmania XT20
- 454 Stratford XT20
- 460 Patina XT20
- 464 Rewind XT20
- 468 Concept XT20

XT20

# Realstone\_Lunar XT20

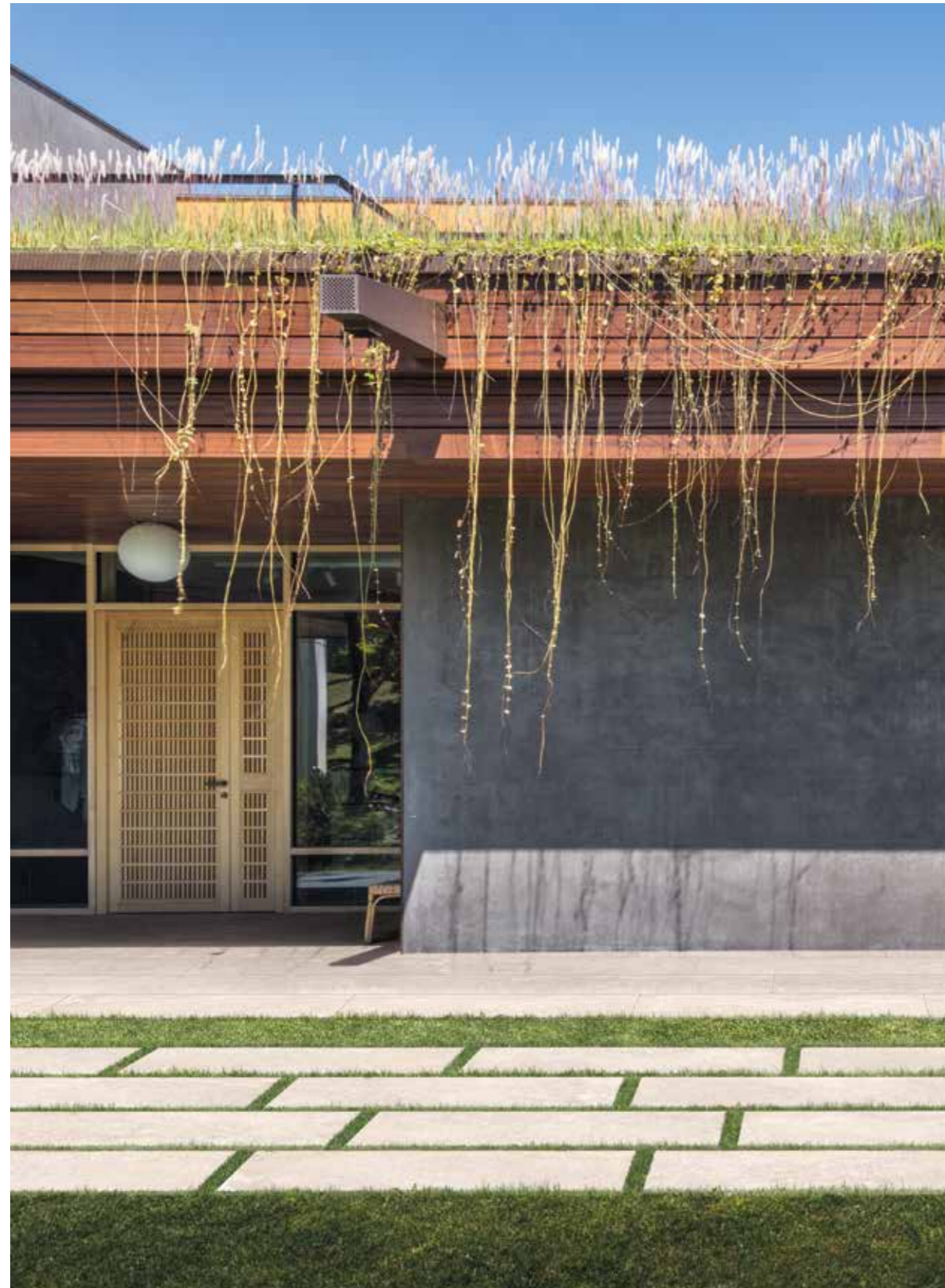

R7DT Beige Rettificato 50x100 - 19<sup>11/16</sup>"x39<sup>3/8</sup>"



## Realstone\_Lunar XT20

gres fine porcellanato colorato in massa - rettificato monocalibro / colorbody fine porcelain stoneware - rectified monocaliber / durchgefärbtes feinsteinzeug - rektifiziert, in einem werkmaß / grès cérame fin coloré dans la masse - rectifié monocalibre / gres porcelánico fino coloreado en toda la masa - rectificado monocalibre / гомогенный мелкозернистый керамогранит - ректифицированный монокалиберный

gruppo Bia UNI EN 14411\_G



outdoor



50x100 cm  
19<sup>11/16</sup>"x39<sup>3/8</sup>"  
± 20 mm

STONE EFFECT  
Realstone\_Lunar > p.138

# Realstone\_Lunar XT20

50x100 - 19 11/16" x 39 3/8"

White



R7DS 50x100 Rett

Silver



R7DU 50x100 Rett

Beige



R7DT 50x100 Rett

Deep Grey

















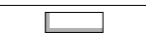
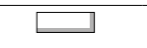
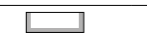
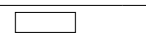
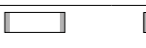
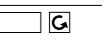
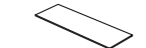

R7DV 50x100 Rett

Uniform

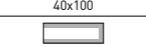

R7DW 50x100 Rett

							
	GRADONE STEP TILE 40x100	GRADONE STEP TILE 40x100	GRADONE STEP TILE 40x100	GRADONE STEP TILE 40x100	ALZATA RISER TILE 20x100	ALZATA RISER TILE 20x100	ALZATA RISER TILE 20x100
LAVORAZIONE LATI TAGLIO + ASSEMBLAGGIO EDGES PRODUCED BY CUTTING + ASSEMBLY							
<b>White</b>	R7TG	R7TN	R7TV	R7UX	R7VE	R7VP	R7VV
<b>Beige</b>	R7TH	R7TP	R7UA	R7UY	R7VG	R7VQ	R7VW
<b>Uniform</b>	R7TL	R7TT	R7UH	R7VC	R7VM	R7VT	R7VZ
<b>Silver</b>	R7TJ	R7TQ	R7UD	R7UZ	R7VJ	R7VR	R7VX
<b>Deep Grey</b>	R7TK	R7TR	R7UG	R7VA	R7VL	R7VS	R7VY
							
	COPRI MURETTO COPING TILE 40x100	COPRI MURETTO COPING TILE 40x100	ELEMENTO ELLE L-EDGING TILE 15x100x4	BORDO U U-EDGING TILE 15x50x15	CORDOLO L L-KERB TILE 15x50x20	CANALINA GUTTER TILE 15x50x8	GRIGLIA GRID TILE 15x50
LAVORAZIONE ROMPIGOCCIA NON-DRIP EDGE							
<b>White</b>	R7WC	R7WJ	R7SX	R7YV	R7WQ	R7ZC	R7ZJ
<b>Beige</b>	R7WD	R7WK	R7TA	R7YW	R7WS	R7ZD	R7ZK
<b>Uniform</b>	R7WG	R7WN	R7TE	R7YZ	R7YT	R7ZE	R7ZN
<b>Silver</b>	R7WE	R7WL	R7TC	R7YX	R7YQ	R7ZE	R7ZL
<b>Deep Grey</b>	R7WF	R7WM	R7TD	R7YY	R7YS	R7ZF	R7ZM

# Realstone\_Lunar XT20

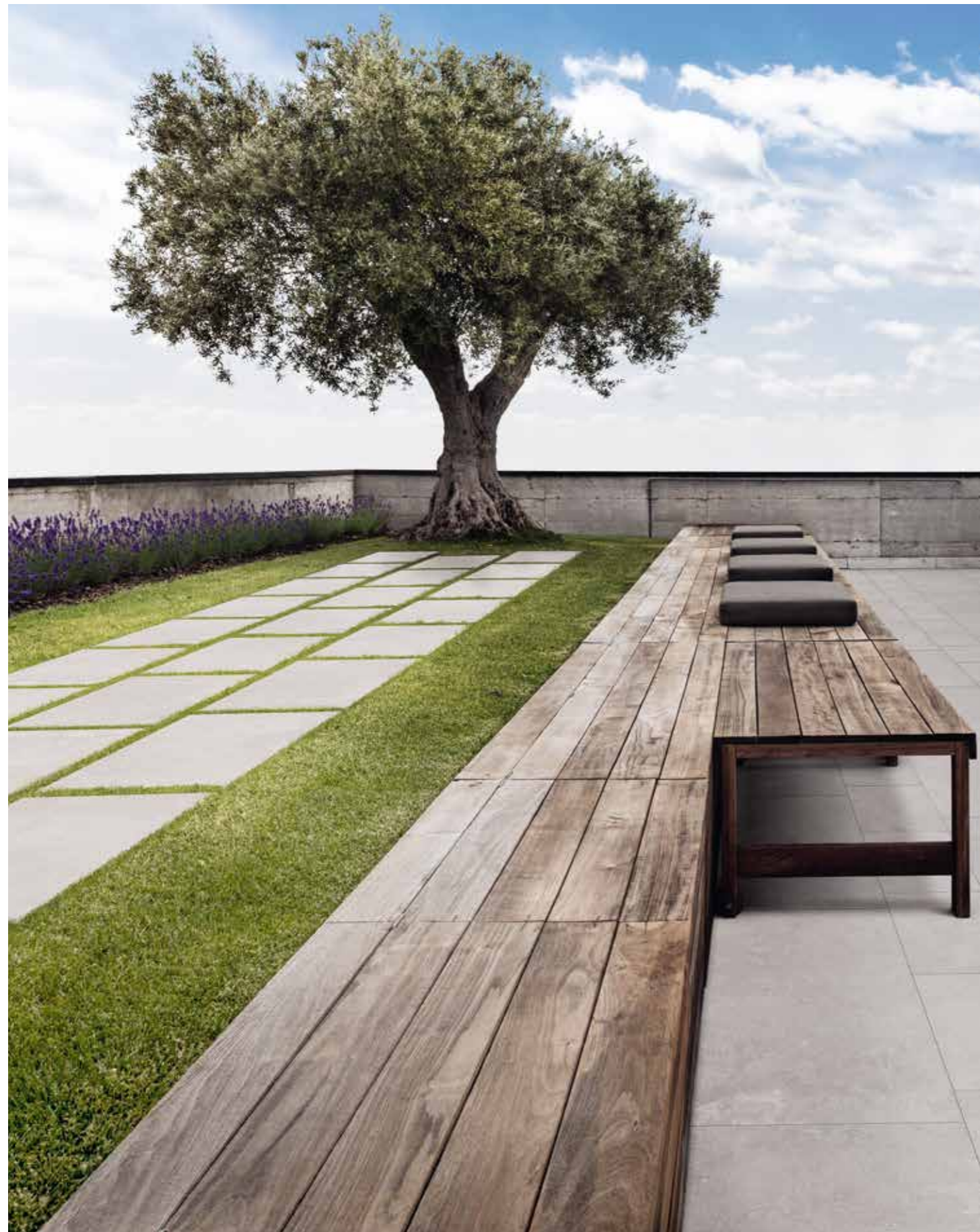

REALSTONE\_LUNAR XT20 | XT20

REALSTONE\_LUNAR XT20 | XT20

R7DS White Rettificato 50x100 - 19<sup>11/16</sup> x 39<sup>3/8</sup>"

## TECH INFO

VARIAZIONI CROMATICHE / COLOUR VARIATIONS / FARBVARIATIONEN / VARIACIONES CROMÁTICAS / ВАРИАНТЫ ОТТЕНКА



V2

Apprezzabili differenze nell'aspetto di superficie e grafica all'interno della stessa produzione / Clearly distinguishable differences in texture and pattern within the same production run / Auffällige Unterschiede in Aussehen und Struktur innerhalb der gleichen Produktionscharge / Différences visibles au niveau de l'aspect et de la fantaisie entre les carreaux du même lot de production / Diferencias visibles en el aspecto de la superficie y los motivos dentro de un mismo lote de producción / заметные отличия вида поверхности и графики в одной и той же партии

DESTINAZIONE D'USO / INTENDED USE / ANWENDUNGSBEREICH / CHAMP D'APPLICATION / USO PREVISTO / НАЗНАЧЕНИЕ

### H (Outdoor)

Materiali consigliati per sollecitazioni all'abrasione relativamente forti in ambienti anche non protetti da agenti graffianti / Materials recommended for relatively heavy abrasion levels, also in premises not protected against abrasive substances / Materials recommended for relatively heavy abrasion levels, also in premises not protected against abrasive substances / Empfohlen für starke Abriebbeanspruchungen in Bereichen auch ohne Kratzschutzbehandlung / Matériaux recommandés pour des locaux soumis à des fortes contraintes d'abrasion, même non protégés contre les agents abrasifs / Materiales recomendados para soportar esfuerzos de abrasión relativamente intensos incluso en espacios no protegidos frente a agentes abrasivos / Материалы рекомендованы для относительно сильного абразивного воздействия, в том числе в помещениях, не защищенных от царапающих элементов

PEZZI SPECIALI / TRIMS / SPEZIALTEILE / PIÈCES SPÉCIALES / PIEZAS ESPECIALES / СПЕЦИАЛЬНЫЕ ИЗДЕЛИЯ

Tutti i pezzi speciali sono su richiesta e sono coordinabili ai fondi rettificati. Gli imballi vengono calcolati sulla base del quantitativo ordinato / All special pieces are supplied to order and can be matched with the rectified plain tiles. Packaging is calculated on the basis of the quantity ordered / Alle Formteile sind auf Anfrage erhältlich und mit den rektifizierten Grundfliesen kombinierbar. Die Verpackung wird auf der Grundlage der Bestellmenge berechnet / Toutes les pièces spéciales sont fabriquées sur demande et coordonnables aux fonds rectifiés. Les emballages sont calculés en fonction de la quantité commandée / Todas las piezas especiales se entregan bajo pedido y se pueden coordinar con los fondos rectificadas. Los embalajes se calculan según las cantidades encargadas en los pedidos / Все специальные изделия производятся на заказ и сочетаются с обрезной фоновой плиткой. Упаковки рассчитываются на основе заказанного количества

Gradone / Step tile, Elemento Elle / L-edging tile, Bordo U / U-edging tile, Cordolo L / L-kerb tile, Canalina / Gutter tile

Assemblato / Two-piece l-tile / Randstein zweiteilig / Assemblé / Montado / Собранный

CONSIGLI DI POSA / INSTALLATION ADVICE / HINWEISE ZUR VERLEGUNG / CONSEILS DE POSE / SUGERENCIAS PARA LA COLOCACIÓN / РЕКОМЕНДАЦИИ ПО УКЛАДКЕ

Per le pavimentazioni esterne non protette, Ragno consiglia di creare una pendenza  $\geq 1,5\%$  sulla superficie calpestabile allo scopo di limitare il formarsi di ristagni d'acqua localizzati. Nel caso in cui questi ristagni permangano sulla superficie delle piastrelle nonostante una posa a regola d'arte, è necessario intervenire meccanicamente con l'utilizzo di scope o aspira-liquidi / For unprotected outdoor pavings, Ragno recommends the creation of a gradient of  $\geq 1.5\%$  on the finished surface, to prevent the formation of patches of standing water. In the event that standing water persists on the surface of the tiles in spite of correct installation, it must be removed mechanically with the aid of brooms or wet-and-dry vacuum cleaners / Zur Unterbindung von punktueller Stauwasserbildung bei Belägen in ungeschützten Außenbereichen, empfiehlt die Ragno die Ausbildung eines Gefälles  $\geq 1,5\%$  auf der Trittläche. Sollte trotz fachgerechter Verlegung Stauwasser auf der Fliesenoberfläche zurückbleiben, ist dessen mechanische Entfernung mit Hilfe eines Besens oder Nasssaugers erforderlich / Pour des sols extérieurs non protégés, Ragno conseille de créer une inclinaison  $\geq 1,5\%$  sur la surface de piétinement en vue de limiter la stagnation localisée de l'eau. Si, malgré une pose dans les règles de l'art, cette stagnation devait persister à la surface des carreaux, une intervention mécanique, au moyen de balais et d'aspirateurs de liquides, est alors nécessaire / En el caso de pavimentaciones exteriores no protegidas, Ragno recomienda crear una pendiente  $\geq 1,5\%$  en la superficie transitable para limitar la formación de depósitos localizados de agua estancada. En caso de que estos depósitos de agua permanezcan en la superficie del azulejo, aun cuando la colocación se haya realizado correctamente, será necesario intervenir mecánicamente empleando un cepillo o un aspirador de líquidos / Для наружных незащищенных полов Ragno рекомендует создавать уклон  $\geq 1,5\%$  на пешеходной поверхности для снижения образования локальных застоев воды. В случае, если застои воды образуются на плитке несмотря на правильную укладку, необходимо прибегать к использованию механических средств, таких как щетки или же аппараты для сбора жидкостей

TECNOLOGIE / TECHNOLOGIES / TECHNOLOGIEN / TECHNOLOGIES / TECNOLOGÍAS / ТЕХНОЛОГИИ

### StepWise

Le piastrelle realizzate con questa nuova tecnologia sono caratterizzate da un'elevata resistenza allo scivolamento e da una superficie morbida al tatto e facile da pulire, data l'assenza di ruvidità superficiale / The tiles produced using this new technology have a high degree of slip resistance and a surface which is soft to the touch and easy to clean, since it has no superficial roughness / Les carreaux utilisant cette nouvelle technologie de production se distinguent par une très grande résistance à la glissance et par une surface douce au toucher et facile à nettoyer puisqu'elle ne présente aucune rugosité / Mit dieser neuen Technologie hergestellte Fliesen zeichnen sich durch eine hohe Rutschhemmung, eine weiche Haptik und eine einfache Reinigung aufgrund der fehlenden Oberflächenrauheit aus / Los azulejos fabricados aplicando esta nueva tecnología se caracterizan por su elevada resistencia al deslizamiento y por presentar una superficie suave al tacto y fácil de limpiar, dada la nula aspereza de su superficie / Произведенная по этой новой технологии плитка обладает высокой стойкостью к скольжению и мягкой на ощупь, легко очищающейся поверхностью, что обеспечивается отсутствием шероховатости на поверхности

CARATTERISTICHE / CHARACTERISTICS / EIGENSCHAFTEN / CARACTERISTIQUES / DATOS / ХАРАКТЕРИСТИКИ

	R11	PENDULUM classe 3 pTV > 36	D-COF > 0,60	BCR $\mu > 0,40$
	C			
		$\leq 175 \text{ mm}^2$		

CERTIFICAZIONI / CERTIFICATIONS / ZERTIFIZIERUNGEN / CERTIFICACIONES / СЕРТИФИКАЦИИ



IMBALLI / PACKAGING / VERPACKUNGEN / EMBALLAGES / EMBALAJES / УПАКОВКИ

	scatole / box / karton / boîte / caja / короб				pallet / pallet / palette / palette / pallet / поддон			
	□	M²	KG		□	M²	KG	± mm
50x100	1	0,50	22,72		50	25,00	1135,85	20

XT20

# Realstone\_Navigli XT20



R7KY Naturale Rettificato 60x120 - 23<sup>5/8</sup>"x47<sup>1/4</sup>"

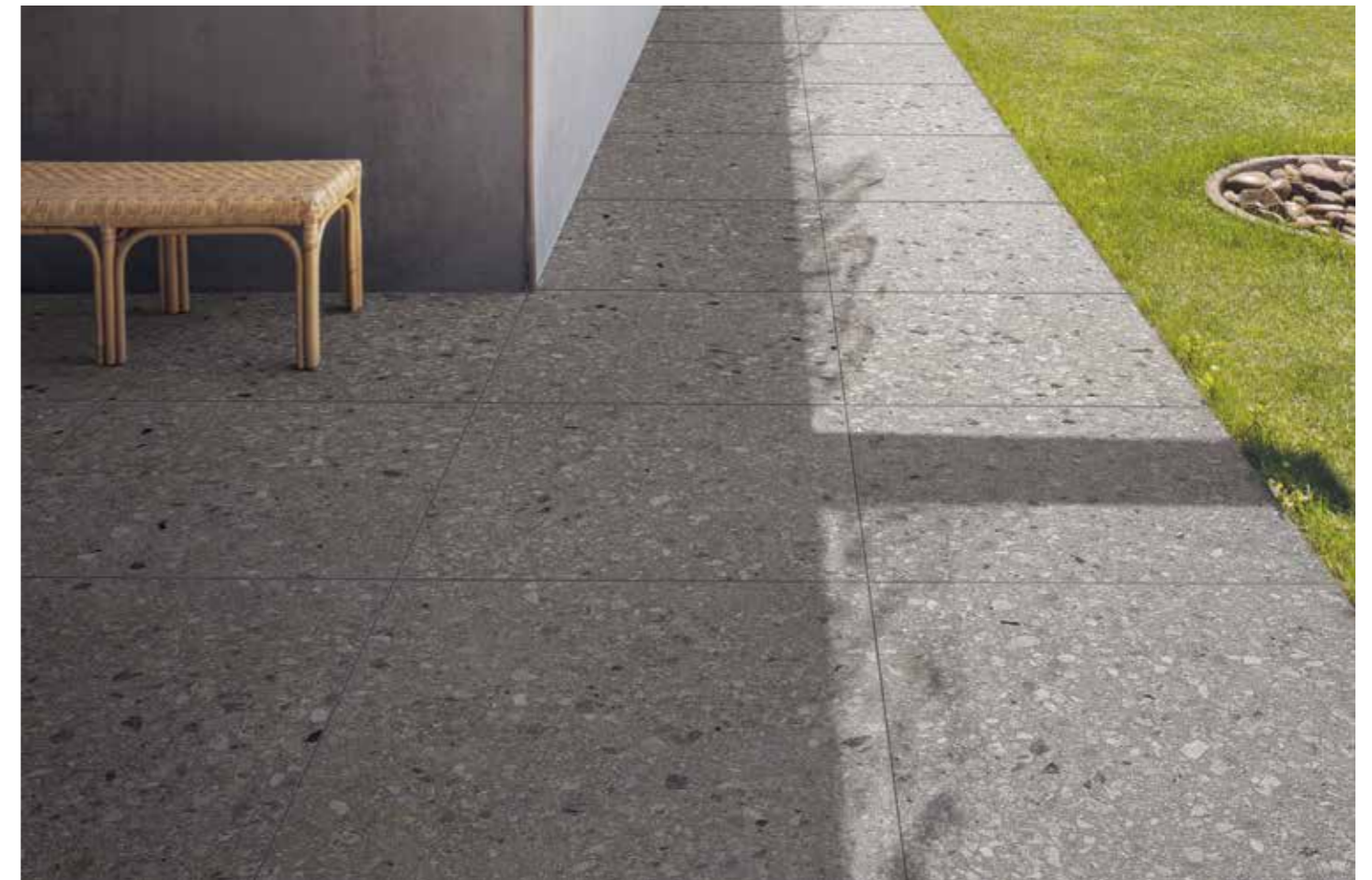

## Realstone\_Navigli XT20

gres fine porcellanato colorato in massa - rettificato monocalibro / colorbody fine porcelain stoneware - rectified monocaliber / durchgefärbtes feinsteinzeug - rektifiziert, in einem werkmaß / grès cérame fin coloré dans la masse - rectifié monocalibre / gres porcelánico fino coloreado en toda la masa - rectificado monocalibre / гомогенный мелкозернистый керамогранит - ректифицированный монокалиберный

gruppo Bla UNI EN 14411\_G



60x120 cm  
23<sup>5/8</sup>"x47<sup>1/4</sup>"  
± 20 mm

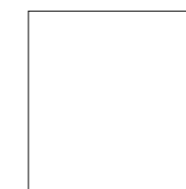

80x80 cm  
31<sup>1/2</sup>"x31<sup>1/2</sup>"  
± 20 mm

STONE EFFECT  
Realstone\_Navigli > p.144



# Realstone\_Navigli XT20

60x120 - 23<sup>9/16</sup>"x47<sup>1/4</sup>" 80x80 - 31<sup>1/2</sup>"x31<sup>1/2</sup>"

## Grigio



**R7KX** 60x120 Rett  
**R7KA** 80x80 Rett

## Naturale



**R7KY** 60x120 Rett  
**R7KC** 80x80 Rett

	GRADONE STEP TILE 40x80	GRADONE STEP TILE 40x80	GRADONE STEP TILE 40x80	GRADONE STEP TILE 40x80	GRADONE STEP TILE 40x120	GRADONE STEP TILE 40x120	GRADONE STEP TILE 40x120	GRADONE STEP TILE 40x120
LAVORAZIONE LATI TAGLIO + ASSEMBLAGGIO EDGES PRODUCED BY CUTTING + ASSEMBLY	SOLO SU LATO LUNGO ON LONG SIDE ONLY	LATO LUNGO + SX LONG SIDE + L	LATO LUNGO + DX LONG SIDE + R	LATO LUNGO + DX + SX LONG SIDE + R + L	SOLO SU LATO LUNGO ON LONG SIDE ONLY	LATO LUNGO + SX LONG SIDE + L	LATO LUNGO + DX LONG SIDE + R	LATO LUNGO + DX + SX LONG SIDE + R + L
<b>Grigio</b>	<b>R7XS</b>	<b>R7XV</b>	<b>R7XY</b>	<b>R7YC</b>	<b>R7RY</b>	<b>R7RS</b>	<b>R7RV</b>	<b>R7SA</b>
<b>Naturale</b>	<b>R7XT</b>	<b>R7XW</b>	<b>R7XZ</b>	<b>R7YD</b>	<b>R7RZ</b>	<b>R7RT</b>	<b>R7RW</b>	<b>R7SC</b>
	ALZATA RISER TILE 20x80	ALZATA RISER TILE 20x80	ALZATA RISER TILE 20x80	ALZATA RISER TILE 20x120	ALZATA RISER TILE 20x120	ALZATA RISER TILE 20x120	ALZATA RISER TILE 20x120	ALZATA RISER TILE 20x120
LAVORAZIONE LATI EDGE SHAPING	NESSUN LATO LAVORATO NO SHAPED EDGES	ENTRABI LATI CORTI BOTH SHORT SIDES	DX/SX RIBALTABILE R/L REVERSIBILE	NESSUN LATO LAVORATO NO SHAPED EDGES	ENTRABI LATI CORTI BOTH SHORT SIDES	ENTRABI LATI CORTI BOTH SHORT SIDES	DX/SX RIBALTABILE R/L REVERSIBILE	DX/SX RIBALTABILE R/L REVERSIBILE
<b>Grigio</b>	<b>R7YF</b>	<b>R7YJ</b>	<b>R80H</b>	<b>R7SE</b>	<b>R7SH</b>	<b>R7SH</b>	<b>R7SL</b>	<b>R7SL</b>
<b>Naturale</b>	<b>R7YG</b>	<b>R7YK</b>	<b>R80J</b>	<b>R7SF</b>	<b>R7SJ</b>	<b>R7SJ</b>	<b>R7SM</b>	<b>R7SM</b>
	COPRI MURETTO COPING TILE 40x80	COPRI MURETTO COPING TILE 40x80	COPRI MURETTO COPING TILE 40x120	COPRI MURETTO COPING TILE 40x120	ELEMENTO ELLE L-EDGING TILE 15x80x4	ELEMENTO ELLE L-EDGING TILE 15x120x4	ELEMENTO ELLE L-EDGING TILE 15x80x4	ELEMENTO ELLE L-EDGING TILE 15x120x4
LAVORAZIONE ROMPIGOCCIA NON-DRIP EDGE	SU 2 LATI LUNGHII ON THE 2 LONG SIDES	SU 3 LATI ON 3 SIDES	SU 2 LATI LUNGHII ON THE 2 LONG SIDES	SU 3 LATI ON 3 SIDES				
<b>Grigio</b>	<b>R81F</b>	<b>R80L</b>	<b>R7SS</b>	<b>R7SP</b>	<b>R7VF</b>	<b>R7RD</b>	<b>R7RD</b>	<b>R7RD</b>
<b>Naturale</b>	<b>R81G</b>	<b>R80M</b>	<b>R7ST</b>	<b>R7SQ</b>	<b>R7VH</b>	<b>R7RF</b>	<b>R7RF</b>	<b>R7RF</b>
	BORDO U U-EDGING TILE 15x80x15	BORDO U U-EDGING TILE 15x60x15	CORDOLO L L-KERB TILE 15x80x20	CORDOLO L L-KERB TILE 15x60x20	CANALINA GUTTER TILE 15x80x8	CANALINA GUTTER TILE 15x60x8	GRIGLIA GRID TILE 15x80	GRIGLIA GRID TILE 15x60
<b>Grigio</b>	<b>R81M</b>	<b>R7UC</b>	<b>R81J</b>	<b>R7TW</b>	<b>R81T</b>	<b>R7UN</b>	<b>R81Q</b>	<b>R7UJ</b>
<b>Naturale</b>	<b>R81N</b>	<b>R7UE</b>	<b>R81K</b>	<b>R7TX</b>	<b>R81U</b>	<b>R7UP</b>	<b>R81R</b>	<b>R7UK</b>

## TECH INFO

VARIAZIONI CROMATICHE / COLOUR VARIATIONS / FARBVARIATIONEN / VARIATIONS CHROMATIQUES / VARIACIONES CROMÁTICAS / ВАРИАНТЫ ОТТЕНКА



Apprezzabili differenze nell'aspetto di superficie e grafica all'interno della stessa produzione / Clearly distinguishable differences in texture and pattern within the same production run / Auffällige Unterschiede in Aussehen und Struktur innerhalb der gleichen Produktionscharge / Différences visibles au niveau de l'aspect et de la fantaisie entre les carreaux du même lot de production / Diferencias visibles en el aspecto de la superficie y los motivos dentro de un mismo lote de producción / заметные отличия вида поверхности и графики в одной и той же партии

DESTINAZIONE D'USO / INTENDED USE / ANWENDUNGSBEREICH / CHAMP D'APPLICATION / USO PREVISTO / НАЗНАЧЕНИЕ

### H (Outdoor)

Materiali consigliati per sollecitazioni all'abrasione relativamente forti in ambienti anche non protetti da agenti graffianti / Materials recommended for relatively heavy abrasion levels, also in premises not protected against abrasive substances / Materials recommended for relatively heavy abrasion levels, also in premises not protected against abrasive substances / Empfohlen für starke Abriebbeanspruchungen in Bereichen auch ohne Kratzschutzbehandlung / Matériaux recommandés pour des locaux soumis à des fortes contraintes d'abrasion, même non protégés contre les agents abrasifs / Materiales recomendados para soportar esfuerzos de abrasión relativamente intensos incluso en espacios no protegidos frente a agentes abrasivos / Материалы рекомендованы для относительно сильного абразивного воздействия, в том числе в помещениях, не защищенных от царапающих элементов

PEZZI SPECIALI / TRIMS / SPEZIALTEILE / PIÈCES SPÉCIALES / PIEZAS ESPECIALES / СПЕЦИАЛЬНЫЕ ИЗДЕЛИЯ

Tutti i pezzi speciali sono su richiesta e sono coordinabili ai fondi rettificati. Gli imballi vengono calcolati sulla base del quantitativo ordinato / All special pieces are supplied to order and can be matched with the rectified plain tiles. Packaging is calculated on the basis of the quantity ordered / Alle Formteile sind auf Anfrage erhältlich und mit den rektifizierten Grundfliesen kombinierbar. Die Verpackung wird auf der Grundlage der Bestellmenge berechnet / Toutes les pièces spéciales sont fabriquées sur demande et coordonnables aux fonds rectifiés. Les emballages sont calculés en fonction de la quantité commandée / Todas las piezas especiales se entregan bajo pedido y se pueden coordinar con los fondos rectificadas. Los embalajes se calculan según las cantidades encargadas en los pedidos / Все специальные изделия производятся на заказ и сочетаются с обрезной фоновой плиткой. Упаковки рассчитываются на основе заказанного количества

### Gradone / Step tile, Elemento Elle / L-edging tile, Bordo U / U-edging tile, Cordolo L / L-kerb tile, Canalina / Gutter tile

Assemblato / Two-piece l-tile / Randstein zweiteilig / Assemblé / Montado / Собранный

CONSIGLI DI POSA / INSTALLATION ADVICE / HINWEISE ZUR VERLEGUNG / CONSEILS DE POSE / SUGERENCIAS PARA LA COLOCACIÓN / РЕКОМЕНДАЦИИ ПО УКЛАДКЕ

Per le pavimentazioni esterne non protette, Ragno consiglia di creare una pendenza  $\geq 1,5\%$  sulla superficie calpestabile allo scopo di limitare il formarsi di ristagni d'acqua localizzati. Nel caso in cui questi ristagni permangano sulla superficie delle piastrelle nonostante una posa a regola d'arte, è necessario intervenire meccanicamente con l'utilizzo di scope o aspira-liquidi / For unprotected outdoor pavings, Ragno recommends the creation of a gradient of  $\geq 1.5\%$  on the finished surface, to prevent the formation of patches of standing water. In the event that standing water persists on the surface of the tiles in spite of correct installation, it must be removed mechanically with the aid of brooms or wet-and-dry vacuum cleaners / Zur Unterbindung von punktueller Stauwasserbildung bei Belägen in ungeschützten Außenbereichen, empfiehlt die Ragno die Ausbildung eines Gefälles  $\geq 1,5\%$  auf der Trittlfläche. Sollte trotz fachgerechter Verlegung Stauwasser auf der Fliesenoberfläche zurückbleiben, ist dessen mechanische Entfernung mit Hilfe eines Besens oder Nasssaugers erforderlich / Pour des sols extérieurs non protégés, Ragno conseille de créer une inclinaison  $\geq 1,5\%$  sur la surface de piétinement en vue de limiter la stagnation localisée de l'eau. Si, malgré une pose dans les règles de l'art, cette stagnation devrait persister à la surface des carreaux, une intervention mécanique, au moyen de balais et d'aspirateurs de liquides, est alors nécessaire / En el caso de pavimentaciones exteriores no protegidas, Ragno recomienda crear una pendiente  $\geq 1,5\%$  en la superficie transitable para limitar la formación de depósitos localizados de agua estancada. En caso de que estos depósitos de agua permanezcan en la superficie del azulejo, aun cuando la colocación se haya realizado correctamente, será necesario intervenir mecánicamente empleando un cepillo o un aspirador de líquidos / Для наружных незащищенных полов Ragno рекомендует создавать уклон  $\geq 1,5\%$  на пешеходной поверхности для снижения образования локальных застоев воды. В случае, если застои воды образуются на плитке несмотря на правильную укладку, необходимо прибегать к использованию механических средств, таких как щетки или же аппараты для сбора жидкостей

TECNOLOGIE / TECHNOLOGIES / TECHNOLOGIEN / TECHNOLOGIES / TECNOLOGÍAS / ТЕХНОЛОГИИ

### StepWise

Le piastrelle realizzate con questa nuova tecnologia sono caratterizzate da un'elevata resistenza allo scivolamento e da una superficie morbida al tatto e facile da pulire, data l'assenza di ruvidità superficiale / The tiles produced using this new technology have a high degree of slip resistance and a surface which is soft to the touch and easy to clean, since it has no superficial roughness / Les carreaux utilisant cette nouvelle technologie de production se distinguent par une très grande résistance à la glissance et par une surface douce au toucher et facile à nettoyer puisqu'elle ne présente aucune rugosité / Mit dieser neuen Technologie hergestellte Fliesen zeichnen sich durch eine hohe Rutschhemmung, eine weiche Haptik und eine einfache Reinigung aufgrund der fehlenden Oberflächenrauheit aus / Los azulejos fabricados aplicando esta nueva tecnología se caracterizan por su elevada resistencia al deslizamiento y por presentar una superficie suave al tacto y fácil de limpiar, dada la nula aspereza de su superficie / Произведенная по этой новой технологии плитка обладает высокой стойкостью к скольжению и мягкой на ощупь, легко очищаемой поверхностью, что обеспечивается отсутствием шероховатости на поверхности

CARATTERISTICHE / CHARACTERISTICS / EIGENSCHAFTEN / CARACTERISTIQUES / DATOS / ХАРАКТЕРИСТИКИ

	<b>R11</b>	<b>PENDULUM classe 3 pTV &gt; 36</b>	<b>D-COF &gt; 0,60</b>	<b>BCR <math>\mu &gt; 0,40</math></b>
	<b>C</b>			
	<b>≤ 175 mm²</b>			

CERTIFICAZIONI / CERTIFICATIONS / ZERTIFIZIERUNGEN / CERTIFICATIONS / CERTIFICACIONES / СЕРТИФИКАЦИИ



IMBALLI / PACKAGING / VERPACKUNGEN / EMBALLAGES / EMBALAJES / УПАКОВКИ

	scatole / box / karton / boîte / caja / короб			pallet / pallet / palette / palette / pallet / поддон			
		M <sup>2</sup>	KG		M <sup>2</sup>	KG	mm
60x120	1	0,72	35,00	36	25,92	1260,08	20
80x80	1	0,64	30,50	45	28,80	1373,00	20

XT20

# Realstone\_PietrAntica XT20



R7KJ Beige Rettificato 60x120 - 23<sup>5/8</sup>"x47<sup>1/4</sup>" - R48F Beige Griglia 15x60 - 5<sup>7/8</sup>"x23<sup>5/8</sup>" - R83W Beige Canalina 15x60x8 - 5<sup>7/8</sup>"x23<sup>5/8</sup>"x3<sup>1/8</sup>"



## Realstone\_PietrAntica XT20

gres fine porcellanato colorato in massa - rettificato monocalibro / colorbody fine porcelain stoneware - rectified monocaliber / durchgefärbtes feinsteinzeug - rektifiziert, in einem werkmaß / grès cérame fin coloré dans la masse - rectifié monocalibre / gres porcelánico fino coloreado en toda la masa - rectificado monocalibre / гомогенный мелкозернистый керамогранит - ректифицированный монокалиберный

gruppo Bla UNI EN 14411\_G



outdoor



60x120 cm  
23<sup>5/8</sup>"x47<sup>1/4</sup>"  
± 20 mm

STONE EFFECT  
Realstone\_PietrAntica > p.148

# Realstone\_PietrAntica XT20

60x120 - 23<sup>5/8</sup>" x 47<sup>1/4</sup>" 60x210 - 23<sup>5/8</sup>" x 82<sup>11/16</sup>"

Bianco



**R7KG** 60x120 Rett

Beige



**R7KJ** 60x120 Rett

Bianco



**R7KU** 60x210 Tumbled Edges  
**R8DP** 60x210 Rett  
[1pz 60x120, 1pz 60x60, 1pz 30x60]

Beige



**R7KV** 60x210 Tumbled Edges  
**R8DR** 60x210 Rett  
[1pz 60x120, 1pz 60x60, 1pz 30x60]

Multicolor



**R7KK** 60x120 Rett

Multicolor



**R7KR** 60x210 Tumbled Edges  
**R8DS** 60x210 Rett  
[1pz 60x120, 1pz 60x60, 1pz 30x60]

REALSTONE\_PIETRANTICA XT20 | XT20

REALSTONE\_PIETRANTICA XT20 | XT20

LAVORAZIONE LATI TAGLIO + ASSEMBLAGGIO EDGES PRODUCED BY CUTTING + ASSEMBLY	SOLO SU LATO LUNGO ON LONG SIDE ONLY	LATO LUNGO + SX LONG SIDE + L	LATO LUNGO + DX LONG SIDE + R	LATO LUNGO + DX + SX LONG SIDE + R + L	SOLO SU LATO LUNGO ON LONG SIDE ONLY	NESSUN LATO LAVORATO NO SHAPED EDGES	ENTRAMBI I LATI CORTI BOTH SHORT SIDES	DX/SX RIBALTABILE R/L REVERSIBLE
<b>GRADONE STEP TILE 40x120</b>	<b>GRADONE STEP TILE 40x120</b>	<b>GRADONE STEP TILE 40x120</b>	<b>GRADONE STEP TILE 40x120</b>	<b>GRADONE STEP TILE 40x120</b>	<b>GRADONE BORDO TORO NON SMALTATO UNGLAZED BULLNOSE STEP 60x120</b>	<b>ALZATA RISER TILE 20x120</b>	<b>ALZATA RISER TILE 20x120</b>	<b>ALZATA RISER TILE 20x120</b>
<b>Bianco</b>	<b>R7ZV</b>	<b>R7ZZ</b>	<b>R803</b>	<b>R807</b>	<b>R9G0</b>	<b>R80C</b>	<b>R80P</b>	<b>R80T</b>
<b>Beige</b>	<b>R7ZW</b>	<b>R800</b>	<b>R804</b>	<b>R808</b>	<b>R9HG</b>	<b>R80D</b>	<b>R80Q</b>	<b>R80U</b>
<b>Multicolor</b>	<b>R7ZX</b>	<b>R801</b>	<b>R805</b>	<b>R809</b>	<b>R9HH</b>	<b>R80E</b>	<b>R80R</b>	<b>R80V</b>

LAVORAZIONE ROMPIGOCCIA NON-DRIP EDGE	SU 2 LATI LUNGHI ON THE 2 LONG SIDES	SU 3 LATI ON 3 SIDES
<b>COPRI MURETTO COPING TILE 40x120</b>	<b>COPRI MURETTO COPING TILE 40x120</b>	<b>ELEMENTO ELLE L-EDGING TILE 15x120x4</b>
<b>Bianco</b>	<b>R82Y</b>	<b>R80X</b>
<b>Beige</b>	<b>R82Z</b>	<b>R80Y</b>
<b>Multicolor</b>	<b>R83A</b>	<b>R80Z</b>

LAVORAZIONE ROMPIGOCCIA NON-DRIP EDGE	SU 2 LATI LUNGHI ON THE 2 LONG SIDES	SU 3 LATI ON 3 SIDES
<b>BORDO U U-EDGING TILE 15x60x15</b>	<b>CORDOLO L L-KERB TILE 15x60x20</b>	<b>CANALINA GUTTER TILE 15x60x8</b>
<b>Bianco</b>	<b>R83M</b>	<b>R83E</b>
<b>Beige</b>	<b>R83N</b>	<b>R83H</b>
<b>Multicolor</b>	<b>R83P</b>	<b>R83K</b>

LAVORAZIONE ROMPIGOCCIA NON-DRIP EDGE	SU 2 LATI LUNGHI ON THE 2 LONG SIDES	SU 3 LATI ON 3 SIDES
<b>GRIGLIA GRID TILE 15x60</b>		
<b>Bianco</b>	<b>R84E</b>	
<b>Beige</b>	<b>R84F</b>	
<b>Multicolor</b>	<b>R84G</b>	

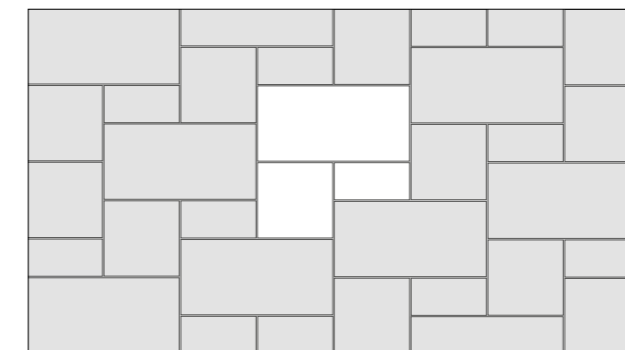

La fuga consigliata per la posa modulare della superficie outdoor nei formati 60x120, 60x60 e 30x60 cm è di 5 mm / The recommended joint for the modular installation of the outdoor surface in the 60x120, 60x60 and 30x60 cm sizes is 5 mm / Nous recommandons un joint de 5 mm pour la pose modulaire de la surface outdoor dans les formats 60x120, 60x60 et 30x60 cm / Für die modulare Verlegung des Außenbelags in den Formaten 60x120, 60x60 und 30x60 cm wird eine Fuge von 5 mm empfohlen / La junta de separación recomendada para la colocación modular en superficies exteriores en los formatos de 60 x 120, 60 x 60 y 30 x 60 cm es de 5 mm / Рекомендованная ширина шва для модульной укладки материалов для наружных пространств в форматах 60x120, 60x60 и 30x60 см равна 5 мм

La produzione di PietrAntica XT20 Tumbled Edges e Bordi Dritti è su richiesta. Ordine minimo: una cassa intera, pari a una superficie di 20,16 m<sup>2</sup> / PietrAntica XT20 with Tumbled Edges and Straight Edges is produced to order. Order unit: whole crate, equal to a surface area of 20.16 m<sup>2</sup> / Die Herstellung von PietrAntica XT20 Tumbled Edges und mit geraden Kanten erfolgt auf Anfrage. Mindestbestellmenge: 1 Kiste, entsprechend einer Fläche von 20,16 m<sup>2</sup> / La production de PietrAntica XT20 Tumbled Edges et Bords droits se fait à la demande. Commande minimale : une caisse entière, équivalent à une superficie de 20,16 m<sup>2</sup> / Las colecciones PietrAntica XT20 Tumbled Edges y Bordes Rectos se fabrican bajo pedido. Pedido mínimo: una caja entera, igual a una superficie de 20,16 m<sup>2</sup> / Производство PietrAntica XT20 Tumbled Edges и с прямыми кромками осуществляется по заказу. Минимальный объем заказа: полный ящик, с площадью материала 20,16 кв.м

# Realstone\_PietrAntica XT20

REALSTONE\_PIESTRANTICA XT20 | XT20



R8DS Multicolor Rett 60x210 - 23<sup>9/8</sup> x 82<sup>11/16</sup>

## TECH INFO

VARIAZIONI CROMATICHE / COLOUR VARIATIONS / FARBVARIATIONEN / VARIATIONS CHROMATIQUES / VARIACIONES CROMÁTICAS / ВАРИАНТЫ ОТТЕНКА

### V2 (Bianco, Beige)

Apprezzabili differenze nell'aspetto di superficie e grafica all'interno della stessa produzione / Clearly distinguishable differences in texture and pattern within the same production run / Auffällige Unterschiede in Aussehen und Struktur innerhalb der gleichen Produktionscharge / Différences visibles au niveau de l'aspect et de la fantaisie entre les carreaux du même lot de production / Diferencias visibles en el aspecto de la superficie y los motivos dentro de un mismo lote de producción / заметные отличия вида поверхности и графики в одной и той же партии

### V4 (Multicolor)

Variazioni irregolari da piastrella a piastrella. Una piastrella può differire totalmente nell'aspetto superficiale e colore da un'altra. Si consiglia di visionare la gamma cromatica prima della selezione del materiale / Random differences from tile to tile. One tile may have totally different texture and colour from another. The colour range should be viewed before selecting the material / Wesentliche Variationen von Fliese zu Fliese. Eine Fliese kann sich in Aussehen und Farbe komplett von einer anderen unterscheiden. Es wird empfohlen, das Farbsortiment vor der Auswahl des Materials zu prüfen / Variations irrégulières entre les carreaux. L'aspect et la couleur peuvent être complètement différents d'un carreau à l'autre. Il est recommandé de consulter la gamme des couleurs avant de sélectionner le matériel / Variaciones irregulares entre un azulejo y otro. Un azulejo puede ser completamente diferente de otro en el aspecto superficial y el color. Es aconsejable visualizar la gama cromática antes de seleccionar el material / Неоднородные изменения на разных плитках. Каждая плитка может полностью отличаться по виду поверхности и цвету от другой. Перед отбором материала рекомендуется посмотреть цветовую гамму

DESTINAZIONE D'USO / INTENDED USE / ANWENDUNGSBEREICH / CHAMP D'APPLICATION / USO PREVISTO / НАЗНАЧЕНИЕ

### H (Outdoor)

Materiali consigliati per sollecitazioni all'abrasione relativamente forti in ambienti anche non protetti da agenti graffianti / Materials recommended for relatively heavy abrasion levels, also in premises not protected against abrasive substances / Materials recommended for relatively heavy abrasion levels, also in premises not protected against abrasive substances / Empfohlen für starke Abriebbeanspruchungen in Bereichen auch ohne Kratzschutzbehandlung / Matériaux recommandés pour des locaux soumis à des fortes contraintes d'abrasion, même non protégés contre les agents abrasifs / Materiales recomendados para soportar esfuerzos de abrasión relativamente intensos incluso en espacios no protegidos frente a agentes abrasivos / Материалы рекомендованы для относительно сильного абразивного воздействия, в том числе в помещениях, не защищенных от царапающих элементов

CARATTERISTICHE / CHARACTERISTICS / EIGENSCHAFTEN / CARACTERISTIQUES / DATOS / ХАРАКТЕРИСТИКИ

	<b>R11</b>	<b>PENDULUM classe 3 p<sub>tv</sub> &gt; 36</b>	<b>D-COF &gt; 0,60</b>	<b>BCR μ &gt; 0,40</b>
	<b>C</b>			
	<b>≤ 175 mm<sup>2</sup></b>			

PEZZI SPECIALI / TRIMS / SPEZIALTEILE / PIÈCES SPÉCIALES / PIEZAS ESPECIALES / СПЕЦИАЛЬНЫЕ ИЗДЕЛИЯ

Tutti i pezzi speciali sono su richiesta e sono coordinabili ai fondi rettificati. Gli imballi vengono calcolati sulla base del quantitativo ordinato / All special pieces are supplied to order and can be matched with the rectified plain tiles. Packaging is calculated on the basis of the quantity ordered / Alle Formteile sind auf Anfrage erhältlich und mit den rektifizierten Grundfliesen kombinierbar. Die Verpackung wird auf der Grundlage der Bestellmenge berechnet / Toutes les pièces spéciales sont fabriquées sur demande et coordonnables aux fonds rectifiés. Les emballages sont calculés en fonction de la quantité commandée / Todas las piezas especiales se entregan bajo pedido y se pueden coordinar con los fondos rectificados. Los embalajes se calculan según las cantidades encargadas en los pedidos / Все специальные изделия производятся на заказ и сочетаются с обрезной фоновой плиткой. Упаковки рассчитываются на основе заказанного количества

Gradone / Step tile, Elemento Elle / L-edging tile, Bordo U / U-edging tile, Cordolo L / L-kerb tile, Canalina / Gutter tile

Assemblato / Two-piece L-tile / Randstein zweiteilig / Assemblé / Montado / Собранный

CONSIGLI DI POSA / INSTALLATION ADVICE / HINWEISE ZUR VERLEGUNG / CONSEILS DE POSE / SUGERENCIAS PARA LA COLOCACIÓN / РЕКОМЕНДАЦИИ ПО УКЛАДКЕ

Per le pavimentazioni esterne non protette, Ragno consiglia di creare una pendenza ≥ 1,5% sulla superficie calpestabile allo scopo di limitare il formarsi di ristagni d'acqua localizzati. Nel caso in cui questi ristagni permangano sulla superficie delle piastrelle nonostante una posa a regola d'arte, è necessario intervenire meccanicamente con l'utilizzo di scope o aspira-liquidi / For unprotected outdoor pavings, Ragno recommends the creation of a gradient of ≥ 1.5% on the finished surface, to prevent the formation of patches of standing water. In the event that standing water persists on the surface of the tiles in spite of correct installation, it must be removed mechanically with the aid of brooms or wet-and-dry vacuum cleaners / Zur Unterbindung von punktueller Stauwasserbildung bei Belägen in ungeschützten Außenbereichen, empfiehlt die Ragno die Ausbildung eines Gefälles ≥ 1,5% auf der Trittlfläche. Sollte trotz fachgerechter Verlegung Stauwasser auf der Fliesenoberfläche zurückbleiben, ist dessen mechanische Entfernung mit Hilfe eines Besens oder Nasssaugers erforderlich / Pour des sols extérieurs non protégés, Ragno conseille de créer une inclinaison ≥ 1,5 % sur la surface de piétinement en vue de limiter la stagnation localisée de l'eau. Si, malgré une pose dans les règles de l'art, cette stagnation devait persister à la surface des carreaux, une intervention mécanique, au moyen de balais et d'aspirateurs de liquides, est alors nécessaire / En el caso de pavimentaciones exteriores no protegidas, Ragno recomienda crear una pendiente ≥ 1,5% en la superficie transitabile para limitar la formación de depósitos localizados de agua estancada. En caso de que estos depósitos de agua permanezcan en la superficie del azulejo, aun cuando la colocación se haya realizado correctamente, será necesario intervenir mecánicamente empleando un cepillo o un aspirador de líquidos / Для наружных незащищенных полов Ragno рекомендует создавать уклон ≥ 1,5% на пешеходной поверхности для снижения образования локальных застоев воды. В случае, если застои воды образуются на плитке несмотря на правильную укладку, необходимо прибегать к использованию механических средств, таких как щетки или же аппараты для сбора жидкостей

CERTIFICAZIONI / CERTIFICATIONS / ZERTIFIZIERUNGEN / CERTIFICACIONES / СЕРТИФИКАЦИИ



IMBALLI / PACKAGING / VERPACKUNGEN / EMBALLAGES / EMBALAJES / УПАКОВКИ

		scatole / box / karton / boîte / caja / короб			pallet / pallet / palette / palette / pallet / поддон			
		□	M <sup>2</sup>	KG	□	M <sup>2</sup>	KG	± mm
60x120	Rettificato	1	0,72	35,00	36	25,92	1260,0	20
60x210	Tumbled edges, Rett	1	1,26	60,00	16	20,16	960,0	20

XT20

# Realstone\_Slate XT20



R648 Musk Rettificato 80x80 - 31 1/2"x31 1/2"



## Realstone\_Slate XT20

gres fine porcellanato colorato in massa - rettificato monocalibro / colorbody fine porcelain stoneware - rectified monocaliber / durchgefärbtes feinsteinzeug - rektifiziert, in einem werkmaß / grès cérame fin coloré dans la masse - rectifié monocalibre / gres porcelánico fino coloreado en toda la masa - rectificado monocalibre / гомогенный мелкозернистый керамогранит - ректифицированный монокалиберный

gruppo Bla UNI EN 14411\_G



outdoor



50x100 cm  
19 11/16" x 39 3/8"  
± 20 mm

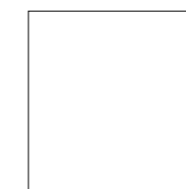

80x80 cm  
31 1/2" x 31 1/2"  
± 20 mm

# Realstone\_Slate XT20

50x100 - 19<sup>11/16</sup>"x39<sup>3/8</sup>" 80x80 - 31<sup>1/2</sup>"x31<sup>1/2</sup>"

## Shell



**R643** 80x80 Rett  
**R63T** 50x100 Rett

## Iron



**R645** 80x80 Rett  
**R63V** 50x100 Rett

## Musk



**R648** 80x80 Rett  
**R63W** 50x100 Rett

## Black



**R64A** 80x80 Rett  
**R63X** 50x100 Rett

## TECH INFO

VARIAZIONI CROMATICHE / COLOUR VARIATIONS / FARBVARIATIONEN / VARIATIONS CHROMATIQUES / VARIACIONES CROMÁTICAS / ВАРИАНТЫ ОТТЕНКА



Apprezzabili differenze nell'aspetto di superficie e grafica all'interno della stessa produzione / Clearly distinguishable differences in texture and pattern within the same production run / Auffällige Unterschiede in Aussehen und Struktur innerhalb der gleichen Produktionscharge / Différences visibles au niveau de l'aspect et de la fantaisie entre les carreaux du même lot de production / Diferencias visibles en el aspecto de la superficie y los motivos dentro de un mismo lote de producción / заметные отличия вида поверхности и графики в одной и той же партии

DESTINAZIONE D'USO / INTENDED USE / ANWENDUNGSBEREICH / CHAMP D'APPLICATION / USO PREVISTO / НАЗНАЧЕНИЕ

### H [Outdoor]

Materiali consigliati per sollecitazioni all'abrasione relativamente forti in ambienti anche non protetti da agenti graffianti / Materials recommended for relatively heavy abrasion levels, also in premises not protected against abrasive substances / Materials recommended for relatively heavy abrasion levels, also in premises not protected against abrasive substances / Empfohlen für starke Abriebbeanspruchungen in Bereichen auch ohne Kratzschutzbehandlung / Matériaux recommandés pour des locaux soumis à des fortes contraintes d'abrasion, même non protégés contre les agents abrasifs / Materiales recomendados para soportar esfuerzos de abrasión relativamente intensos incluso en espacios no protegidos frente a agentes abrasivos / Материалы рекомендованы для относительно сильного абразивного воздействия, в том числе в помещениях, не защищенных от царапающих элементов

PEZZI SPECIALI / TRIMS / SPEZIALTEILE / PIÈCES SPÉCIALES / PIEZAS ESPECIALES / СПЕЦИАЛЬНЫЕ ИЗДЕЛИЯ

Tutti i pezzi speciali sono su richiesta e sono coordinabili ai fondi rettificati. Gli imballi vengono calcolati sulla base del quantitativo ordinato / All special pieces are supplied to order and can be matched with the rectified plain tiles. Packaging is calculated on the basis of the quantity ordered / Alle Formteile sind auf Anfrage erhältlich und mit den rektifizierten Grundfliesen kombinierbar. Die Verpackung wird auf der Grundlage der Bestellmenge berechnet / Toutes les pièces spéciales sont fabriquées sur demande et coordonnables aux fonds rectifiés. Les emballages sont calculés en fonction de la quantité commandée / Todas las piezas especiales se entregan bajo pedido y se pueden coordinar con los fondos rectificadas. Los embalajes se calculan según las cantidades encargadas en los pedidos / Все специальные изделия производятся на заказ и сочетаются с обрезной фоновой плиткой. Упаковки рассчитываются на основе заказанного количества

Gradone / Step tile, Elemento Elle / L-edging tile, Bordo U / U-edging tile, Cordolo L / L-kerb tile, Canalina / Gutter tile

Assemblato / Two-piece l-tile / Randstein zweiteilig / Assemblé / Montado / Собранный

CONSIGLI DI POSA / INSTALLATION ADVICE / HINWEISE ZUR VERLEGUNG / CONSEILS DE POSE / SUGERENCIAS PARA LA COLOCACIÓN / РЕКОМЕНДАЦИИ ПО УКЛАДКЕ

Per le pavimentazioni esterne non protette, Ragno consiglia di creare una pendenza  $\geq 1,5\%$  sulla superficie calpestabile allo scopo di limitare il formarsi di ristagni d'acqua localizzati. Nel caso in cui questi ristagni permangano sulla superficie delle piastrelle nonostante una posa a regola d'arte, è necessario intervenire meccanicamente con l'utilizzo di scope o aspira-liquidi / For unprotected outdoor pavings, Ragno recommends the creation of a gradient of  $\geq 1,5\%$  on the finished surface, to prevent the formation of patches of standing water. In the event that standing water persists on the surface of the tiles in spite of correct installation, it must be removed mechanically with the aid of brooms or wet-and-dry vacuum cleaners / Zur Unterbindung von punktueller Stauwasserbildung bei Belägen in ungeschützten Außenbereichen, empfiehlt die Ragno die Ausbildung eines Gefälles  $\geq 1,5\%$  auf der Trittläche. Sollte trotz fachgerechter Verlegung Stauwasser auf der Fliesenoberfläche zurückbleiben, ist dessen mechanische Entfernung mit Hilfe eines Besens oder Nasssaugers erforderlich / Pour des sols extérieurs non protégés, Ragno conseille de créer une inclinaison  $\geq 1,5\%$  sur la surface de piétinement en vue de limiter la stagnation localisée de l'eau. Si, malgré une pose dans les règles de l'art, cette stagnation devait persister à la surface des carreaux, une intervention mécanique, au moyen de balais et d'aspirateurs de liquides, est alors nécessaire / En el caso de pavimentaciones exteriores no protegidas, Ragno recomienda crear una pendiente  $\geq 1,5\%$  en la superficie transitable para limitar la formación de depósitos localizados de agua estancada. En caso de que estos depósitos de agua permanezcan en la superficie del azulejo, aun cuando la colocación se haya realizado correctamente, será necesario intervenir mecánicamente empleando un cepillo o un aspirador de líquidos / Для наружных незащищенных полов Ragno рекомендует создавать уклон  $\geq 1,5\%$  на пешеходной поверхности для снижения образования локальных застоев воды. В случае, если застои воды образуются на плитке несмотря на правильную укладку, необходимо прибегать к использованию механических средств, таких как щетки или же аппараты для сбора жидкостей

REALSTONE\_SLABE XT20 | XT20

REALSTONE\_SLABE XT20 | XT20

	GRADONE STEP TILE 40x80	GRADONE STEP TILE 40x80	GRADONE STEP TILE 40x80	GRADONE STEP TILE 40x80	GRADONE BORDO TORO NON SMALTATO UNGLAZED BULLNOSE STEP 40x80	GRADONE STEP TILE 40x100	GRADONE STEP TILE 40x100	GRADONE STEP TILE 40x100	GRADONE STEP TILE 40x100
LAVORAZIONE LATI TAGLIO + ASSEMBLAGGIO EDGES PRODUCED BY CUTTING + ASSEMBLY	SOLO SU LATO LUNGO ON LONG SIDE ONLY	LATO LUNGO + SX LONG SIDE + L	LATO LUNGO + DX LONG SIDE + R	LATO LUNGO + DX + SX LONG SIDE + R + L	SOLO SU LATO LUNGO ON LONG SIDE ONLY	SOLO SU LATO LUNGO ON LONG SIDE ONLY	LATO LUNGO + SX LONG SIDE + L	LATO LUNGO + DX LONG SIDE + R	LATO LUNGO + DX + SX LONG SIDE + R + L
Shell	R699	R69K	R69Z	R6AK	R9H4	R64R	R650	R65C	R65P
Iron	R69C	R69M	R6AC	R6AM	R9H5	R64T	R652	R65F	R65R
Musk	R69E	R69Q	R6AE	R6AP	R9H6	R64V	R654	R65H	R65T
Black	R69G	R69S	R6AG	R6AR	R9H8	R64X	R658	R65K	R65V
		ALZATA RISER TILE 20x80	ALZATA RISER TILE 20x80	ALZATA RISER TILE 20x80	ALZATA RISER TILE 20x100	ALZATA RISER TILE 20x100	ALZATA RISER TILE 20x100	ALZATA RISER TILE 20x100	ALZATA RISER TILE 20x100
LAVORAZIONE LATI EDGE SHAPING	NESSUN LATO LAVORATO NO SHAPED EDGES	ENTRAMBI I LATI CORTI BOTH SHORT SIDES	DX/SX RIBALTABILE R/L REVERSIBLE	NESSUN LATO LAVORATO NO SHAPED EDGES	ENTRAMBI I LATI CORTI BOTH SHORT SIDES	DX/SX RIBALTABILE R/L REVERSIBLE	NESSUN LATO LAVORATO NO SHAPED EDGES	ENTRAMBI I LATI CORTI BOTH SHORT SIDES	DX/SX RIBALTABILE R/L REVERSIBLE
Shell	R6AU	R6CD	R6CN	R667	R66L	R66V	R66A	R66N	R66X
Iron	R6AW	R6CF	R6CQ	R669	R66N	R66X	R66A	R66N	R66X
Musk	R6AY	R6CH	R6CS	R66C	R66Q	R66Z	R66A	R66N	R66X
Black	R6C0	R6CK	R6CU	R66E	R66S	R671	R66A	R66N	R66X
	COPRI MURETTO COPING TILE 40x80	COPRI MURETTO COPING TILE 40x80	COPRI MURETTO COPING TILE 40x120	COPRI MURETTO COPING TILE 40x120	ELEMENTO ELLE L-EDGING TILE 15x80x4	ELEMENTO ELLE L-EDGING TILE 15x100x4			
LAVORAZIONE ROMPIGOCCIA NON-DRIP EDGE	SU 2 LATI LUNGHI ON THE 2 LONG SIDES	SU 3 LATI ON 3 SIDES	SU 2 LATI LUNGHI ON THE 2 LONG SIDES	SU 3 LATI ON 3 SIDES					
Shell	R6CX	R6DH	R674	R670	R68Y	R64E			
Iron	R6CZ	R6DK	R678	R67J	R690	R64H			
Musk	R6DC	R6DM	R67A	R67L	R692	R64L			
Black	R6DE	R6DP	R67D	R67N	R695	R64N			
	BORDO U U-EDGING TILE 15x80x15	BORDO U U-EDGING TILE 15x50x15	CORDOLO L L-KERB TILE 15x80x20	CORDOLO L L-KERB TILE 15x50x20	CANALINA GUTTER TILE 15x80x8	CANALINA GUTTER TILE 15x50x8	GRIGLIA GRID TILE 15x80	GRIGLIA GRID TILE 15x50	
Shell	R6EC	R681	R6DS	R67R	R6EX	R68C	R6EN	R68P	
Iron	R6EE	R683	R6DU	R67U	R6F9	R68E	R6EQ	R68R	
Musk	R6EH	R685	R6DW	R67W	R6FC	R68H	R6ES	R68T	
Black	R6EK	R688	R6DY	R67Y	R6FE	R68K	R6EU	R68V	

CARATTERISTICHE / CHARACTERISTICS / EIGENSCHAFTEN / CARACTERISTIQUES / DATOS / ХАРАКТЕРИСТИКИ

CERTIFICAZIONI / CERTIFICATIONS / ZERTIFIZIERUNGEN / CERTIFICATIONS / CERTIFICACIONES / СЕРТИФИКАЦИИ

	<b>R11</b>	<b>PENDULUM classe 3 p<sub>tv</sub> &gt; 36</b>	<b>D-COF &gt; 0,60</b>	<b>BCR <math>\mu &gt; 0,40</math></b>
	<b>B</b>			
	<b>≤ 175 mm<sup>2</sup></b>			



IMBALLI / PACKAGING / VERPACKUNGEN / EMBALLAGES / EMBALAJES / УПАКОВКИ

	scatole / box / karton / boîte / caja / короб			pallet / pallet / palette / palette / pallet / поддон			
		M <sup>2</sup>	KG		M <sup>2</sup>	KG	mm
50x100	1	0,50	23,50	50	25,00	1175,00	20
80x80	1	0,64	30,50	45	28,80	1373,00	20

XT20

# Realstone\_Rain XT20

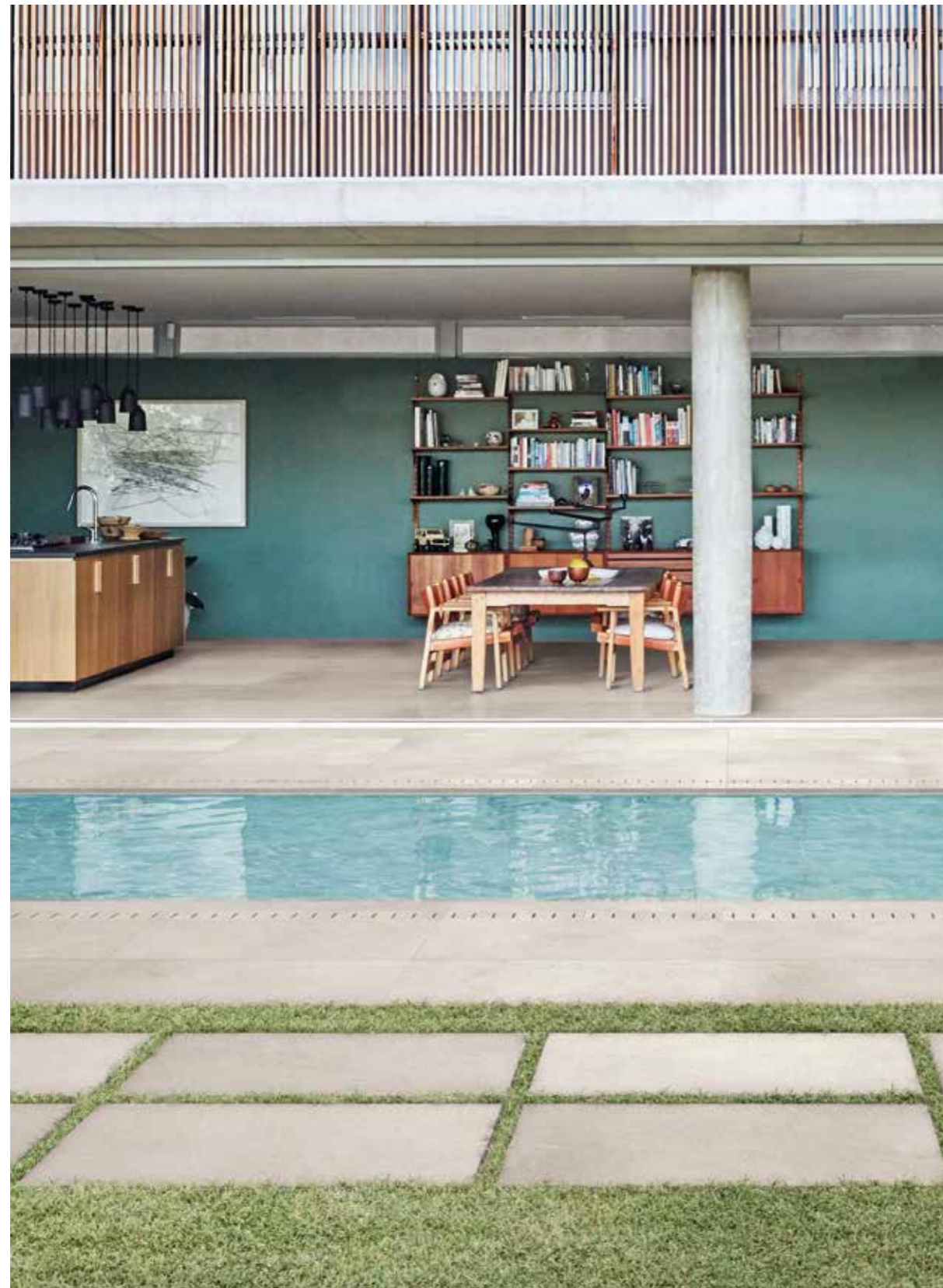

**RAWS** Almond Rettificato 50x100 - 19<sup>11/16</sup>"x39<sup>3/8</sup>" - **RAZN** Almond Griglia 15x50 - 5<sup>7/8</sup>"x19<sup>11/16</sup>"  
**RAZR** Almond Canalina 15x50x8 - 5<sup>7/8</sup>"x19<sup>11/16</sup>"x3<sup>1/8</sup>" - **RAYK** Almond Elemento Elle 15x100x4 - 5<sup>7/8</sup>"x39<sup>3/8</sup>"x19<sup>1/16</sup>"



## Realstone\_Rain XT20

gres fine porcellanato colorato in massa - rettificato monocalibro / colorbody fine porcelain stoneware - rectified monocaliber / durchgefärbtes feinsteinzeug - rektifiziert, in einem werkmaß / grès cérame fin coloré dans la masse - rectifié monocalibre / gres porcelánico fino coloreado en toda la masa - rectificado monocalibre / гомогенный мелкозернистый керамогранит - ректифицированный монокалиберный

gruppo Bla UNI EN 14411\_G



outdoor



**50x100 cm**  
 19<sup>11/16</sup>"x39<sup>3/8</sup>"  
 ± 20 mm

**STONE EFFECT**  
 Realstone\_Rain > p.160

# Realstone\_Rain XT20

50x100 - 19<sup>1/16"</sup> x 39<sup>3/8"</sup>

## Almond



RAWS 50x100 Rett

## Greige



RAWT 50x100 Rett

## Taupe

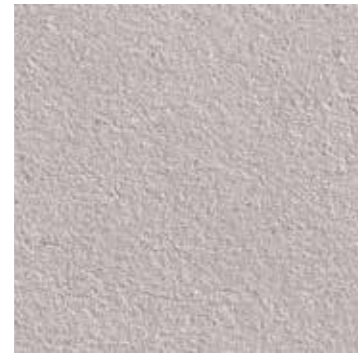

RAWU 50x100 Rett

## TECH INFO

VARIAZIONI CROMATICHE / COLOUR VARIATIONS / FARBVARIATIONEN / VARIATIONS CHROMATIQUES / VARIACIONES CROMÁTICAS / ВАРИАНТЫ ОТТЕНКА



Apprezzabili differenze nell'aspetto di superficie e grafica all'interno della stessa produzione / Clearly distinguishable differences in texture and pattern within the same production run / Auffällige Unterschiede in Aussehen und Struktur innerhalb der gleichen Produktionscharge / Différences visibles au niveau de l'aspect et de la fantaisie entre les carreaux du même lot de production / Diferencias visibles en el aspecto de la superficie y los motivos dentro de un mismo lote de producción / заметные отличия вида поверхности и графики в одной и той же партии

DESTINAZIONE D'USO / INTENDED USE / ANWENDUNGSBEREICH / CHAMP D'APPLICATION / USO PREVISTO / НАЗНАЧЕНИЕ

### H (Outdoor)

Materiali consigliati per sollecitazioni all'abrasione relativamente forti in ambienti anche non protetti da agenti graffianti / Materials recommended for relatively heavy abrasion levels, also in premises not protected against abrasive substances / Materials recommended for relatively heavy abrasion levels, also in premises not protected against abrasive substances / Empfohlen für starke Abriebbeanspruchungen in Bereichen auch ohne Kratzschutzbehandlung / Matériaux recommandés pour des locaux soumis à des fortes contraintes d'abrasion, même non protégés contre les agents abrasifs / Materiales recomendados para soportar esfuerzos de abrasión relativamente intensos incluso en espacios no protegidos frente a agentes abrasivos / Материалы рекомендованы для относительно сильного абразивного воздействия, в том числе в помещениях, не защищенных от царапающих элементов

PEZZI SPECIALI / TRIMS / SPEZIALTEILE / PIÈCES SPÉCIALES / PIEZAS ESPECIALES / СПЕЦИАЛЬНЫЕ ИЗДЕЛИЯ

Tutti i pezzi speciali sono su richiesta e sono coordinabili ai fondi rettificati. Gli imballi vengono calcolati sulla base del quantitativo ordinato / All special pieces are supplied to order and can be matched with the rectified plain tiles. Packaging is calculated on the basis of the quantity ordered / Alle Formteile sind auf Anfrage erhältlich und mit den rektifizierten Grundfliesen kombinierbar. Die Verpackung wird auf der Grundlage der Bestellmenge berechnet / Toutes les pièces spéciales sont fabriquées sur demande et coordonnables aux fonds rectifiés. Les emballages sont calculés en fonction de la quantité commandée / Todas las piezas especiales se entregan bajo pedido y se pueden coordinar con los fondos rectificadas. Los embalajes se calculan según las cantidades encargadas en los pedidos / Все специальные изделия производятся на заказ и сочетаются с обрезной фоновой плиткой. Упаковки рассчитываются на основе заказанного количества

Gradone / Step tile, Elemento Elle / L-edging tile, Bordo U / U-edging tile, Cordolo L / L-kerb tile, Canalina / Gutter tile

Assemblato / Two-piece l-tile / Randstein zweiteilig / Assemblé / Montado / Собранный

CONSIGLI DI POSA / INSTALLATION ADVICE / HINWEISE ZUR VERLEGUNG / CONSEILS DE POSE / SUGERENCIAS PARA LA COLOCACIÓN / РЕКОМЕНДАЦИИ ПО УКЛАДКЕ

Per le pavimentazioni esterne non protette, Ragno consiglia di creare una pendenza  $\geq 1,5\%$  sulla superficie calpestabile allo scopo di limitare il formarsi di ristagni d'acqua localizzati. Nel caso in cui questi ristagni permangano sulla superficie delle piastrelle nonostante una posa a regola d'arte, è necessario intervenire meccanicamente con l'utilizzo di scope o aspira-liquidi / For unprotected outdoor pavings, Ragno recommends the creation of a gradient of  $\geq 1,5\%$  on the finished surface, to prevent the formation of patches of standing water. In the event that standing water persists on the surface of the tiles in spite of correct installation, it must be removed mechanically with the aid of brooms or wet-and-dry vacuum cleaners / Zur Unterbindung von punktueller Stauwasserbildung bei Belägen in ungeschützten Außenbereichen, empfiehlt die Ragno die Ausbildung eines Gefälles  $\geq 1,5\%$  auf der Trittlfläche. Sollte trotz fachgerechter Verlegung Stauwasser auf der Fliesenoberfläche zurückbleiben, ist dessen mechanische Entfernung mit Hilfe eines Besens oder Nasssaugers erforderlich / Pour des sols extérieurs non protégés, Ragno conseille de créer une inclinaison  $\geq 1,5\%$  sur la surface de piétinement en vue de limiter la stagnation localisée de l'eau. Si, malgré une pose dans les règles de l'art, cette stagnation devait persister à la surface des carreaux, une intervention mécanique, au moyen de balais et d'aspirateurs de liquides, est alors nécessaire / En el caso de pavimentaciones exteriores no protegidas, Ragno recomienda crear una pendiente  $\geq 1,5\%$  en la superficie transitada para limitar la formación de depósitos localizados de agua estancada. En caso de que estos depósitos de agua permanezcan en la superficie del azulejo, aun cuando la colocación se haya realizado correctamente, será necesario intervenir mecánicamente empleando un cepillo o un aspirador de líquidos / Для наружных незащищенных полов Ragno рекомендует создавать уклон  $\geq 1,5\%$  на пешеходной поверхности для снижения образования локальных застоев воды. В случае, если застои воды образуются на плитке несмотря на правильную укладку, необходимо прибегать к использованию механических средств, таких как щетки или же аппараты для сбора жидкостей

	GRADONE STEP TILE 40x100	GRADONE STEP TILE 40x100	GRADONE STEP TILE 40x100	GRADONE STEP TILE 40x100	ALZATA RISER TILE 20x100	ALZATA RISER TILE 20x100	ALZATA RISER TILE 20x100
LAVORAZIONE LATI TAGLIO + ASSEMBLAGGIO EDGES PRODUCED BY CUTTING + ASSEMBLY	SOLO SU LATO LUNGO ON LONG SIDE ONLY	LATO LUNGO + SX LONG SIDE + L	LATO LUNGO + DX LONG SIDE + R	LATO LUNGO + DX + SX LONG SIDE + R + L	NESSUN LATO LAVORATO NO SHAPED EDGES	ENTRAMBI I LATI CORTI BOTH SHORT SIDES	DX/SX RIBALTABILE R/L REVERSIBLE
Almond	RAYN	RAYR	RAYU	RAYX	RAZ0	RAZ3	RAZ6
Greige	RAYP	RAYS	RAYV	RAYY	RAZ1	RAZ4	RAZ7
Taupe	RAYQ	RAYT	RAYW	RAYZ	RAZ2	RAZ5	RAZ8
	COPRI MURETTO COPING TILE 40x100	COPRI MURETTO COPING TILE 40x100	ELEMENTO ELLE L-EDGING TILE 15x100x4	BORDO U U-EDGING TILE 15x50x15	CORDOLO L L-KERB TILE 15x50x20	CANALINA GUTTER TILE 15x50x8	GRIGLIA GRID TILE 15x50
LAVORAZIONE ROMPIGOCCIA NON-DRIP EDGE	SU 2 LATI LUNGHICI ON THE 2 LONG SIDES	SU 3 LATI ON 3 SIDES					
Almond	RAZ9	RAZD	RAYK	RAZK	RAZG	RAZR	RAZN
Greige	RAZA	RAZE	RAYL	RAZL	RAZH	RAZS	RAZP
Taupe	RAZC	RAZF	RAYM	RAZM	RAZJ	RAZT	RAZQ

CARATTERISTICHE / CHARACTERISTICS / EIGENSCHAFTEN / CARACTERISTIQUES / DATOS / ХАРАКТЕРИСТИКИ

	R11	PENDULUM classe 3 p <sub>tv</sub> > 36	D-COF > 0,60	BCR $\mu > 0,40$
	B			
	$\leq 175 \text{ mm}^2$			

CERTIFICAZIONI / CERTIFICATIONS / ZERTIFIZIERUNGEN / CERTIFICACIONES / CERTIFICACIONES / СЕРТИФИКАЦИИ



IMBALLI / PACKAGING / VERPACKUNGEN / EMBALLAGES / EMBALAJES / УПАКОВКИ

	scatole / box / karton / boîte / caja / коробк			pallet / pallet / palette / palette / pallet / поддон			+ mm
	M <sup>2</sup>	KG		M <sup>2</sup>	KG		
50x100	1	0,50	23,50	50	25,00	1175,00	20



XT20

# Realstone\_Cardoso XT20



R06W Grigio Rettificato 50x100 - 19<sup>11/16</sup> x 39<sup>3/8</sup>"



## Realstone\_Cardoso XT20

gres fine porcellanato colorato in massa - rettificato monocalibro / colorbody fine porcelain stoneware - rectified monocaliber / durchgefärbtes feinsteinzeug - rektifiziert, in einem werkmaß / grès cérame fin coloré dans la masse - rectifié monocalibre / gres porcelánico fino coloreado en toda la masa - rectificado monocalibre / гомогенный мелкозернистый керамогранит - ректифицированный монокалиберный

gruppo Bla UNI EN 14411\_G



outdoor



50x100 cm  
19<sup>11/16</sup> x 39<sup>3/8</sup>"  
± 20 mm

STONE EFFECT  
Realstone\_Cardoso > p.166

# Realstone\_Cardoso XT20

50x100 - 19<sup>1/16</sup>" x 39<sup>3/8</sup>"

## Silver

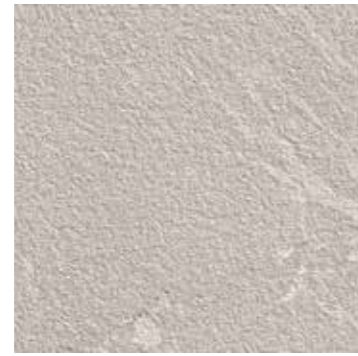

R18G 50x100 Rett

## Grigio



R06W 50x100 Rett

## Antracite



R18F 50x100 Rett

## TECH INFO

VARIAZIONI CROMATICHE / COLOUR VARIATIONS / FARBVARIATIONEN / VARIATIONS CHROMATIQUES / VARIACIONES CROMÁTICAS / ВАРИАНТЫ ОТТЕНКА



Apprezzabili differenze nell'aspetto di superficie e grafica all'interno della stessa produzione / Clearly distinguishable differences in texture and pattern within the same production run / Auffällige Unterschiede in Aussehen und Struktur innerhalb der gleichen Produktionscharge / Différences visibles au niveau de l'aspect et de la fantaisie entre les carreaux du même lot de production / Diferencias visibles en el aspecto de la superficie y los motivos dentro de un mismo lote de producción / заметные отличия вида поверхности и графики в одной и той же партии

DESTINAZIONE D'USO / INTENDED USE / ANWENDUNGSBEREICH / CHAMP D'APPLICATION / USO PREVISTO / НАЗНАЧЕНИЕ

### H (Outdoor)

Materiali consigliati per sollecitazioni all'abrasione relativamente forti in ambienti anche non protetti da agenti graffianti / Materials recommended for relatively heavy abrasion levels, also in premises not protected against abrasive substances / Materials recommended for relatively heavy abrasion levels, also in premises not protected against abrasive substances / Empfohlen für starke Abriebbeanspruchungen in Bereichen auch ohne Kratzschutzbehandlung / Matériaux recommandés pour des locaux soumis à des fortes contraintes d'abrasion, même non protégés contre les agents abrasifs / Materiales recomendados para soportar esfuerzos de abrasión relativamente intensos incluso en espacios no protegidos frente a agentes abrasivos / Материалы рекомендованы для относительно сильного абразивного воздействия, в том числе в помещениях, не защищенных от царапающих элементов

PEZZI SPECIALI / TRIMS / SPEZIALTEILE / PIÈCES SPÉCIALES / PIEZAS ESPECIALES / СПЕЦИАЛЬНЫЕ ИЗДЕЛИЯ

Tutti i pezzi speciali sono su richiesta e sono coordinabili ai fondi rettificati. Gli imballi vengono calcolati sulla base del quantitativo ordinato / All special pieces are supplied to order and can be matched with the rectified plain tiles. Packaging is calculated on the basis of the quantity ordered / Alle Formteile sind auf Anfrage erhältlich und mit den rektifizierten Grundfliesen kombinierbar. Die Verpackung wird auf der Grundlage der Bestellmenge berechnet / Toutes les pièces spéciales sont fabriquées sur demande et coordonnables aux fonds rectifiés. Les emballages sont calculés en fonction de la quantité commandée / Todas las piezas especiales se entregan bajo pedido y se pueden coordinar con los fondos rectificadas. Los embalajes se calculan según las cantidades encargadas en los pedidos / Все специальные изделия производятся на заказ и сочетаются с обрезной фоновой плиткой. Упаковки рассчитываются на основе заказанного количества

Gradone / Step tile, Elemento Elle / L-edging tile, Bordo U / U-edging tile, Cordolo L / L-kerb tile, Canalina / Gutter tile

Assemblato / Two-piece l-tile / Randstein zweiteilig / Assemblé / Montado / Собранный

CONSIGLI DI POSA / INSTALLATION ADVICE / HINWEISE ZUR VERLEGUNG / CONSEILS DE POSE / SUGERENCIAS PARA LA COLOCACIÓN / РЕКОМЕНДАЦИИ ПО УКЛАДКЕ

Per le pavimentazioni esterne non protette, Ragno consiglia di creare una pendenza  $\geq 1,5\%$  sulla superficie calpestabile allo scopo di limitare il formarsi di ristagni d'acqua localizzati. Nel caso in cui questi ristagni permangano sulla superficie delle piastrelle nonostante una posa a regola d'arte, è necessario intervenire meccanicamente con l'utilizzo di scope o aspira-liquidi / For unprotected outdoor pavings, Ragno recommends the creation of a gradient of  $\geq 1,5\%$  on the finished surface, to prevent the formation of patches of standing water. In the event that standing water persists on the surface of the tiles in spite of correct installation, it must be removed mechanically with the aid of brooms or wet-and-dry vacuum cleaners / Zur Unterbindung von punktueller Stauwasserbildung bei Belägen in ungeschützten Außenbereichen, empfiehlt die Ragno die Ausbildung eines Gefälles  $\geq 1,5\%$  auf der Tritfläche. Sollte trotz fachgerechter Verlegung Stauwasser auf der Fliesenoberfläche zurückbleiben, ist dessen mechanische Entfernung mit Hilfe eines Besens oder Nasssaugers erforderlich / Pour des sols extérieurs non protégés, Ragno conseille de créer une inclinaison  $\geq 1,5\%$  sur la surface de piétinement en vue de limiter la stagnation localisée de l'eau. Si, malgré une pose dans les règles de l'art, cette stagnation devait persister à la surface des carreaux, une intervention mécanique, au moyen de balais et d'aspirateurs de liquides, est alors nécessaire / En el caso de pavimentaciones exteriores no protegidas, Ragno recomienda crear una pendiente  $\geq 1,5\%$  en la superficie transitable para limitar la formación de depósitos localizados de agua estancada. En caso de que estos depósitos de agua permanezcan en la superficie del azulejo, aun cuando la colocación se haya realizado correctamente, será necesario intervenir mecánicamente empleando un cepillo o un aspirador de líquidos / Для наружных незащищенных полов Ragno рекомендует создавать уклон  $\geq 1,5\%$  на пешеходной поверхности для снижения образования локальных застоев воды. В случае, если застои воды образуются на плитке несмотря на правильную укладку, необходимо прибегать к использованию механических средств, таких как щетки или же аппараты для сбора жидкостей

	GRADONE STEP TILE 40x100	GRADONE STEP TILE 40x100	GRADONE STEP TILE 40x100	GRADONE STEP TILE 40x100	ALZATA RISER TILE 20x100	ALZATA RISER TILE 20x100	ALZATA RISER TILE 20x100
LAVORAZIONE LATI TAGLIO + ASSEMBLAGGIO EDGES PRODUCED BY CUTTING + ASSEMBLY	SOLO SU LATO LUNGO ON LONG SIDE ONLY	LATO LUNGO + SX LONG SIDE + L	LATO LUNGO + DX LONG SIDE + R	LATO LUNGO + DX + SX LONG SIDE + R + L	NESSUN LATO LAVORATO NO SHAPED EDGES	ENTRAMBI I LATI CORTI BOTH SHORT SIDES	DX/SX RIBALTABILE R/L REVERSIBLE
Silver	R18L	R18N	R18Q	R18S	R18U	R18W	R18Y
Grigio	R09M	R09N	R09P	R09Q	R09R	R09S	R09T
Antracite	R18K	R18M	R18P	R18R	R18T	R18V	R18X
	COPRI MURETTO COPING TILE 40x100	COPRI MURETTO COPING TILE 40x100	ELEMENTO ELLE L-EDGING TILE 15x100x4	BORDO U U-EDGING TILE 15x50x15	CORDOLO L L-KERB TILE 15x50x20	CANALINA GUTTER TILE 15x50x8	GRIGLIA GRID TILE 15x50
LAVORAZIONE ROMPIGOCCIA NON-DRIP EDGE	SU 2 LATI LUNGHICI ON THE 2 LONG SIDES	SU 3 LATI ON 3 SIDES					
Silver	R190	R192	R18J	R19D	R19A	R19H	R19F
Grigio	R09U	R09V	R09L	R09X	R09W	R09Y	R09Z
Antracite	R18Z	R191	R18H	R19C	R193	R19G	R19E

CARATTERISTICHE / CHARACTERISTICS / EIGENSCHAFTEN / CARACTERISTIQUES / DATOS / ХАРАКТЕРИСТИКИ

R11	PENDULUM classe 3 pTV > 36	D-COF > 0,60	BCR $\mu > 0,40$
B			
	$\leq 175 \text{ mm}^2$		

CERTIFICAZIONI / CERTIFICATIONS / ZERTIFIZIERUNGEN / CERTIFICACIONES / CERTIFICACIONES / СЕРТИФИКАЦИИ



IMBALLI / PACKAGING / VERPACKUNGEN / EMBALLAGES / EMBALAJES / УПАКОВКИ

	scatole / box / karton / boîte / caja / коробк			pallet / pallet / palette / palette / pallet / поддон		
	M <sup>2</sup>	KG		M <sup>2</sup>	KG	mm
50x100	1	0,50	23,50	50	25,00	1175,00 20

XT20

# Realstone\_Jerusalem XT20



R06Y Noce Rettificato 50x100 - 19<sup>11/16</sup>"x39<sup>3/8</sup>"



## Realstone\_Jerusalem XT20

gres fine porcellanato colorato in massa - rettificato monocalibro / colorbody fine porcelain stoneware - rectified monocaliber / durchgefärbtes feinsteinzeug - rektifiziert, in einem werkmaß / grès cérame fin coloré dans la masse - rectifié monocalibre / gres porcelánico fino coloreado en toda la masa - rectificado monocalibre / гомогенный мелкозернистый керамогранит - ректифицированный монокалиберный

gruppo Bla UNI EN 14411\_G



outdoor



50x100 cm  
19<sup>11/16</sup>"x39<sup>3/8</sup>"  
± 20 mm

STONE EFFECT  
Realstone\_Jerusalem > p.170

# Realstone\_Jerusalem XT20

50x100 - 19<sup>1/16</sup>" x 39<sup>3/8</sup>"

Avorio



R06X 50x100 Rett

Noce



R06Y 50x100 Rett

Grigio



R12E 50x100 Rett

## TECH INFO

VARIAZIONI CROMATICHE / COLOUR VARIATIONS / FARBVARIATIONEN / VARIATIONS CHROMATIQUES / VARIACIONES CROMÁTICAS / ВАРИАНТЫ ОТТЕНКА



**V2**  
Apprezzabili differenze nell'aspetto di superficie e grafica all'interno della stessa produzione / Clearly distinguishable differences in texture and pattern within the same production run / Auffällige Unterschiede in Aussehen und Struktur innerhalb der gleichen Produktionscharge / Différences visibles au niveau de l'aspect et de la fantaisie entre les carreaux du même lot de production / Diferencias visibles en el aspecto de la superficie y los motivos dentro de un mismo lote de producción / заметные отличия вида поверхности и графики в одной и той же партии

DESTINAZIONE D'USO / INTENDED USE / ANWENDUNGSBEREICH / CHAMP D'APPLICATION / USO PREVISTO / НАЗНАЧЕНИЕ

### H (Outdoor)

Materiali consigliati per sollecitazioni all'abrasione relativamente forti in ambienti anche non protetti da agenti graffianti / Materials recommended for relatively heavy abrasion levels, also in premises not protected against abrasive substances / Materials recommended for relatively heavy abrasion levels, also in premises not protected against abrasive substances / Empfohlen für starke Abriebbeanspruchungen in Bereichen auch ohne Kratzschutzbehandlung / Matériaux recommandés pour des locaux soumis à des fortes contraintes d'abrasion, même non protégés contre les agents abrasifs / Materiales recomendados para soportar esfuerzos de abrasión relativamente intensos incluso en espacios no protegidos frente a agentes abrasivos / Материалы рекомендованы для относительно сильного абразивного воздействия, в том числе в помещениях, не защищенных от царапающих элементов

PEZZI SPECIALI / TRIMS / SPEZIALTEILE / PIÈCES SPÉCIALES / PIEZAS ESPECIALES / СПЕЦИАЛЬНЫЕ ИЗДЕЛИЯ

Tutti i pezzi speciali sono su richiesta e sono coordinabili ai fondi rettificati. Gli imballi vengono calcolati sulla base del quantitativo ordinato / All special pieces are supplied to order and can be matched with the rectified plain tiles. Packaging is calculated on the basis of the quantity ordered / Alle Formteile sind auf Anfrage erhältlich und mit den rektifizierten Grundfliesen kombinierbar. Die Verpackung wird auf der Grundlage der Bestellmenge berechnet / Toutes les pièces spéciales sont fabriquées sur demande et coordonnables aux fonds rectifiés. Les emballages sont calculés en fonction de la quantité commandée / Todas las piezas especiales se entregan bajo pedido y se pueden coordinar con los fondos rectificadas. Los embalajes se calculan según las cantidades encargadas en los pedidos / Все специальные изделия производятся на заказ и сочетаются с обрезной фоновой плиткой. Упаковки рассчитываются на основе заказанного количества

Gradone / Step tile, Elemento Elle / L-edging tile, Bordo U / U-edging tile, Cordolo L / L-kerb tile, Canalina / Gutter tile

Assemblato / Two-piece l-tile / Randstein zweiteilig / Assemblé / Montado / Собранная

CONSIGLI DI POSA / INSTALLATION ADVICE / HINWEISE ZUR VERLEGUNG / CONSEILS DE POSE / SUGERENCIAS PARA LA COLOCACIÓN / РЕКОМЕНДАЦИИ ПО УКЛАДКЕ

Per le pavimentazioni esterne non protette, Ragno consiglia di creare una pendenza  $\geq 1,5\%$  sulla superficie calpestabile allo scopo di limitare il formarsi di ristagni d'acqua localizzati. Nel caso in cui questi ristagni permangano sulla superficie delle piastrelle nonostante una posa a regola d'arte, è necessario intervenire meccanicamente con l'utilizzo di scope o aspira-liquidi / For unprotected outdoor pavings, Ragno recommends the creation of a gradient of  $\geq 1.5\%$  on the finished surface, to prevent the formation of patches of standing water. In the event that standing water persists on the surface of the tiles in spite of correct installation, it must be removed mechanically with the aid of brooms or wet-and-dry vacuum cleaners / Zur Unterbindung von punktueller Stauwasserbildung bei Belägen in ungeschützten Außenbereichen, empfiehlt die Ragno die Ausbildung eines Gefälles  $\geq 1,5\%$  auf der Trittlfläche. Sollte trotz fachgerechter Verlegung Stauwasser auf der Fliesenoberfläche zurückbleiben, ist dessen mechanische Entfernung mit Hilfe eines Besens oder Nasssaugers erforderlich / Pour des sols extérieurs non protégés, Ragno conseille de créer une inclinaison  $\geq 1,5\%$  sur la surface de piétinement en vue de limiter la stagnation localisée de l'eau. Si, malgré une pose dans les règles de l'art, cette stagnation devait persister à la surface des carreaux, une intervention mécanique, au moyen de balais et d'aspirateurs de liquides, est alors nécessaire / En el caso de pavimentaciones exteriores no protegidas, Ragno recomienda crear una pendiente  $\geq 1,5\%$  en la superficie transitable para limitar la formación de depósitos localizados de agua estancada. En caso de que estos depósitos de agua permanezcan en la superficie del azulejo, aun cuando la colocación se haya realizado correctamente, será necesario intervenir mecánicamente empleando un cepillo o un aspirador de líquidos / Для наружных незащищенных полов Ragno рекомендует создавать уклон  $\geq 1,5\%$  на пешеходной поверхности для снижения образования локальных застоев воды. В случае, если застои воды образуются на плитке несмотря на правильную укладку, необходимо прибегать к использованию механических средств, таких как щетки или же аппараты для сбора жидкостей

REALSTONE\_JERUSALEM XT20 | XT20

REALSTONE\_JERUSALEM XT20 | XT20

	GRADONE STEP TILE 40x100	GRADONE STEP TILE 40x100	GRADONE STEP TILE 40x100	GRADONE STEP TILE 40x100	GRADONE BORDO TORO NON SMALTATO UNGLAZED BULLNOSE STEP 50x100	ALZATA RISER TILE 20x100	ALZATA RISER TILE 20x100	ALZATA RISER TILE 20x100
LAVORAZIONE LATI TAGLIO + ASSEMBLAGGIO EDGES PRODUCED BY CUTTING + ASSEMBLY	SOLO SU LATO LUNGO ON LONG SIDE ONLY	LATO LUNGO + SX LONG SIDE + L	LATO LUNGO + DX LONG SIDE + R	LATO LUNGO + DX + SX LONG SIDE + R + L	SOLO SU LATO LUNGO ON LONG SIDE ONLY	NESSUN LATO LAVORATO NO SHAPED EDGES	ENTRAMBI I LATI CORTI BOTH SHORT SIDES	DX/SX RIBALTABILE R/L REVERSIBLE
Avorio	R060	R062	R064	R0J4	R96K	R0NN	R0NQ	R0NS
Noce	R061	R063	R0J3	R0J5	R96L	R0NP	R0NR	R0NT
Grigio	R13F	R13G	R13H	R13J	R96M	R13K	R13L	R13M
		COPRI MURETTO COPING TILE 40x100	COPRI MURETTO COPING TILE 40x100	ELEMENTO ELLE L-EDGING TILE 15x100x4	BORDO U U-EDGING TILE 15x50x15	CORDOLO L L-KERB TILE 15x50x20	CANALINA GUTTER TILE 15x50x8	GRIGLIA GRID TILE 15x50
LAVORAZIONE ROMPIGOCCIA NON-DRIP EDGE	SU 2 LATI LUNGHICI ON THE 2 LONG SIDES	SU 3 LATI ON 3 SIDES						
Avorio	R0NX	R0NZ	R0C9	R0RD	R0QZ	R10A	R10E	
Noce	R0NY	R0PA	R0CE	R0TN	R0RA	R10C	R10F	
Grigio	R13N	R13P	R13E	R13R	R13Q	R12Y	R12W	

CARATTERISTICHE / CHARACTERISTICS / EIGENSCHAFTEN / CARACTERISTIQUES / DATOS / ХАРАКТЕРИСТИКИ

CERTIFICAZIONI / CERTIFICATIONS / ZERTIFIZIERUNGEN / CERTIFICATIONS / CERTIFICACIONES / СЕРТИФИКАЦИИ

R11	PENDULUM classe 3 p <sub>tv</sub> > 36	D-COF > 0,60	BCR $\mu > 0,40$
B			
≤ 175 mm <sup>2</sup>			



IMBALLI / PACKAGING / VERPACKUNGEN / EMBALLAGES / EMBALAJES / УПАКОВКИ

	scatole / box / karton / boîte / caja / коробк			pallet / pallet / palette / palette / pallet / поддон			
	□	M <sup>2</sup>	KG	□	M <sup>2</sup>	KG	± mm
50x100	1	0,50	23,50	50	25,00	1175,00	20

XT20

# Realstone\_Quarzite XT20



R076 Grigio Rettificato 50x100 - 19<sup>11/16</sup>"x39<sup>3/8</sup>"



## Realstone\_Quarzite XT20

gres fine porcellanato colorato in massa - rettificato monocalibro / colorbody fine porcelain stoneware - rectified monocaliber / durchgefärbtes feinsteinzeug - rektifiziert, in einem werkmaß / grès cérame fin coloré dans la masse - rectifié monocalibre / gres porcelánico fino coloreado en toda la masa - rectificado monocalibre / гомогенный мелкозернистый керамогранит - ректифицированный монокалиберный

gruppo Bla UNI EN 14411\_G



outdoor



50x100 cm  
19<sup>11/16</sup>"x39<sup>3/8</sup>"  
± 20 mm

STONE EFFECT  
Realstone\_Quarzite > p.176

# Realstone\_Quarzite XT20

50x100 - 19<sup>11/16</sup> x 39<sup>3/8</sup>"

Bianco



R07H 50x100 Rett

Grigio



R07G 50x100 Rett

## TECH INFO

VARIAZIONI CROMATICHE / COLOUR VARIATIONS / FARBVARIATIONEN / VARIATIONS CHROMATIQUES / VARIACIONES CROMÁTICAS / ВАРИАНТЫ ОТТЕНКА



Significativa variazione di aspetto superficiale, grafica e colore da piastrella a piastrella e all'interno della stessa piastrella. Si consiglia di visionare la gamma cromatica prima della selezione del materiale / Significant variation in texture, pattern and colour from tile to tile within the same production run. The colour range should be viewed before selecting the material / Bedeutende Variation in Aussehen, Struktur und Farbe von Fliese zu Fliese und in ein und derselben Fliese. Es wird empfohlen, das Farbsortiment vor der Auswahl des Materials zu prüfen / Variation significative au niveau de l'aspect, de la fantaisie et de la couleur entre les carreaux et au sein d'un même carreau. Il est recommandé de consulter la gamme des couleurs avant de sélectionner le matériel / Variación considerable en el aspecto superficial, los motivos y el color entre un azulejo y otro y dentro del propio azulejo. Es aconsejable visualizar la gama cromática antes de seleccionar el material / Значительные отличия вида поверхности, графики и цвета у разных плиток и на одной и той же плитке. Перед отбором материала рекомендуется посмотреть цветовую гамму

PEZZI SPECIALI / TRIMS / SPEZIALTEILE / PIÈCES SPÉCIALES / PIEZAS ESPECIALES / СПЕЦИАЛЬНЫЕ ИЗДЕЛИЯ

Tutti i pezzi speciali sono su richiesta e sono coordinabili ai fondi rettificati. Gli imballi vengono calcolati sulla base del quantitativo ordinato / All special pieces are supplied to order and can be matched with the rectified plain tiles. Packaging is calculated on the basis of the quantity ordered / Alle Formteile sind auf Anfrage erhältlich und mit den rektifizierten Grundfliesen kombinierbar. Die Verpackung wird auf der Grundlage der Bestellmenge berechnet / Toutes les pièces spéciales sont fabriquées sur demande et coordonnables aux fonds rectifiés. Les emballages sont calculés en fonction de la quantité commandée / Todas las piezas especiales se entregan bajo pedido y se pueden coordinar con los fondos rectificadas. Los embalajes se calculan según las cantidades encargadas en los pedidos / Все специальные изделия производятся на заказ и сочетаются с обрезной фоновой плиткой. Упаковки рассчитываются на основе заказанного количества

Gradone / Step tile, Elemento Elle / L-edging tile, Bordo U / U-edging tile, Cordolo L / L-kerb tile, Canalina / Gutter tile

Assemblato / Two-piece L-tile / Randstein zweiteilig / Assemblé / Montado / Собранный

DESTINAZIONE D'USO / INTENDED USE / ANWENDUNGSBEREICH / CHAMP D'APPLICATION / USO PREVISTO / НАЗНАЧЕНИЕ

### H (Outdoor)

Materiali consigliati per sollecitazioni all'abrasione relativamente forti in ambienti anche non protetti da agenti graffianti / Materials recommended for relatively heavy abrasion levels, also in premises not protected against abrasive substances / Materials recommended for relatively heavy abrasion levels, also in premises not protected against abrasive substances / Empfohlen für starke Abriebbeanspruchungen in Bereichen auch ohne Kratzschutzbehandlung / Matériaux recommandés pour des locaux soumis à des fortes contraintes d'abrasion, même non protégés contre les agents abrasifs / Materiales recomendados para soportar esfuerzos de abrasión relativamente intensos incluso en espacios no protegidos frente a agentes abrasivos / Материалы рекомендованы для относительно сильного абразивного воздействия, в том числе в помещениях, не защищенных от царапающих элементов

CONSIGLI DI POSA / INSTALLATION ADVICE / HINWEISE ZUR VERLEGUNG / CONSEILS DE POSE / SUGERENCIAS PARA LA COLOCACIÓN / РЕКОМЕНДАЦИИ ПО УКЛАДКЕ

Per le pavimentazioni esterne non protette, Ragno consiglia di creare una pendenza  $\geq 1,5\%$  sulla superficie calpestabile allo scopo di limitare il formarsi di ristagni d'acqua localizzati. Nel caso in cui questi ristagni permangano sulla superficie delle piastrelle nonostante una posa a regola d'arte, è necessario intervenire meccanicamente con l'utilizzo di scope o aspira-liquidi / For unprotected outdoor pavings, Ragno recommends the creation of a gradient of  $\geq 1.5\%$  on the finished surface, to prevent the formation of patches of standing water. In the event that standing water persists on the surface of the tiles in spite of correct installation, it must be removed mechanically with the aid of brooms or wet-and-dry vacuum cleaners / Zur Unterbindung von punktueller Stauwasserbildung bei Belägen in ungeschützten Außenbereichen, empfiehlt die Ragno die Ausbildung eines Gefälles  $\geq 1,5\%$  auf der Trittlfläche. Sollte trotz fachgerechter Verlegung Stauwasser auf der Fliesenoberfläche zurückbleiben, ist dessen mechanische Entfernung mit Hilfe eines Besens oder Nasssaugers erforderlich / Pour des sols extérieurs non protégés, Ragno conseille de créer une inclinaison  $\geq 1,5\%$  sur la surface de piétinement en vue de limiter la stagnation localisée de l'eau. Si, malgré une pose dans les règles de l'art, cette stagnation devait persister à la surface des carreaux, une intervention mécanique, au moyen de balais et d'aspirateurs de liquides, est alors nécessaire / En el caso de pavimentaciones exteriores no protegidas, Ragno recomienda crear una pendiente  $\geq 1,5\%$  en la superficie transitable para limitar la formación de depósitos localizados de agua estancada. En caso de que estos depósitos de agua permanezcan en la superficie del azulejo, aun cuando la colocación se haya realizado correctamente, será necesario intervenir mecánicamente empleando un cepillo o un aspirador de líquidos / Для наружных незащищенных полов Ragno рекомендует создавать уклон  $\geq 1,5\%$  на пешеходной поверхности для снижения образования локальных застоев воды. В случае, если застои воды образуются на плитке несмотря на правильную укладку, необходимо прибегать к использованию механических средств, таких как щетки или же аппараты для сбора жидкостей

	GRADONE STEP TILE 40x100	GRADONE STEP TILE 40x100	GRADONE STEP TILE 40x100	GRADONE STEP TILE 40x100	ALZATA RISER TILE 20x100	ALZATA RISER TILE 20x100	ALZATA RISER TILE 20x100
LAVORAZIONE LATI TAGLIO + ASSEMBLAGGIO EDGES PRODUCED BY CUTTING + ASSEMBLY	SOLO SU LATO LUNGO ON LONG SIDE ONLY	LATO LUNGO + SX LONG SIDE + L	LATO LUNGO + DX LONG SIDE + R	LATO LUNGO + DX + SX LONG SIDE + R + L	NESSUN LATO LAVORATO NO SHAPED EDGES	ENTRAMB I LATI CORTI BOTH SHORT SIDES	DX/SX RIBALTABILE R/L REVERSIBLE
Bianco	R10L	R10N	R10Q	R10S	R10U	R10Z	R11C
Grigio	R10M	R10P	R10R	R10T	R10V	R11A	R11D
	COPRI MURETTO COPING TILE 40x100	COPRI MURETTO COPING TILE 40x100	ELEMENTO ELLE L-EDGING TILE 15x100x4	BORDO U U-EDGING TILE 15x50x15	CORDOLO L L-KERB TILE 15x50x20	CANALINA GUTTER TILE 15x50x8	GRIGLIA GRID TILE 15x50
LAVORAZIONE ROMPIGOCCIA NON-DRIP EDGE	SU 2 LATI LUNGI ON THE 2 LONG SIDES	SU 3 LATI ON 3 SIDES					
Bianco	R11E	R11G	R10G	R11L	R11J	R11N	R10Q
Grigio	R11F	R11H	R10J	R11M	R11K	R11P	R10R

CARATTERISTICHE / CHARACTERISTICS / EIGENSCHAFTEN / CARACTERISTIQUES / DATOS / ХАРАКТЕРИСТИКИ

	R11	PENDULUM classe 3 ptv > 36	D-COF > 0,60	BCR $\mu > 0,40$
	B			
		$\leq 175 \text{ mm}^2$		

CERTIFICAZIONI / CERTIFICATIONS / ZERTIFIZIERUNGEN / CERTIFICACIONES / CERTIFICACIONES / СЕРТИФИКАЦИИ



IMBALLI / PACKAGING / VERPACKUNGEN / EMBALLAGES / EMBALAJES / УПАКОВКИ

	scatole / box / karton / boîte / caja / коробк			pallet / pallet / palette / palette / pallet / поддон			
	□	M <sup>2</sup>	KG	□	M <sup>2</sup>	KG	± mm
50x100	1	0,50	23,50	50	25,00	1175,00	20

XT20

## Stoneway\_Ardesia XT20



R5V3 Beige Rettificato 60x60 - 23<sup>5/8</sup>" x 23<sup>5/8</sup>"



### Stoneway\_Ardesia XT20

gres fine porcellanato colorato in massa - rettificato monocalibro / colorbody fine porcelain stoneware - rectified monocaliber / durchgefärbtes feinsteinzeug - rektifiziert, in einem werkmaß / grès cérame fin coloré dans la masse - rectifié monocalibre / gres porcelánico fino coloreado en toda la masa - rectificado monocalibre / гомогенный мелкозернистый керамогранит - ректифицированный монокалиберный

gruppo Bla UNI EN 14411\_G



outdoor

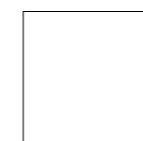

60x60 cm  
23<sup>5/8</sup>" x 23<sup>5/8</sup>"  
± 20 mm

STONE EFFECT  
Stoneway\_Ardesia > p.182

# Stoneway\_Ardesia XT20

60x60 - 23<sup>5/8</sup>" x 23<sup>5/8</sup>"

Beige



R5V3 60x60 Rett

Grigio



R5U2 60x60 Rett

Antracite



R5V4 60x60 Rett

## TECH INFO

VARIAZIONI CROMATICHE / COLOUR VARIATIONS / FARBVARIATIONEN / VARIATIONS CHROMATIQUES / VARIACIONES CROMÁTICAS / ВАРИАНТЫ ОТТЕНКА



Significativa variazione di aspetto superficiale, grafica e colore da piastrella a piastrella e all'interno della stessa piastrella. Si consiglia di visionare la gamma cromatica prima della selezione del materiale / Significant variation in texture, pattern and colour from tile to tile within the same production run. The colour range should be viewed before selecting the material / Bedeutende Variation in Aussehen, Struktur und Farbe von Fliese zu Fliese und in ein und derselben Fliese. Es wird empfohlen, das Farbsortiment vor der Auswahl des Materials zu prüfen / Variation significative au niveau de l'aspect, de la fantaisie et de la couleur entre les carreaux et au sein d'un même carreau. Il est recommandé de consulter la gamme des couleurs avant de sélectionner le matériel / Variación considerable en el aspecto superficial, los motivos y el color entre un azulejo y otro y dentro del propio azulejo. Es aconsejable visualizar la gama cromática antes de seleccionar el material / Значительные отличия вида поверхности, графики и цвета у разных плиток и на одной и той же плитке. Перед отбором материала рекомендуется посмотреть цветовую гамму

DESTINAZIONE D'USO / INTENDED USE / ANWENDUNGSBEREICH / CHAMP D'APPLICATION / USO PREVISTO / НАЗНАЧЕНИЕ

### H (Outdoor)

Materiali consigliati per sollecitazioni all'abrasione relativamente forti in ambienti anche non protetti da agenti graffianti / Materials recommended for relatively heavy abrasion levels, also in premises not protected against abrasive substances / Materials recommended for relatively heavy abrasion levels, also in premises not protected against abrasive substances / Empfohlen für starke Abriebbeanspruchungen in Bereichen auch ohne Kratzschutzbehandlung / Matériaux recommandés pour des locaux soumis à des fortes contraintes d'abrasion, même non protégés contre les agents abrasifs / Materiales recomendados para soportar esfuerzos de abrasión relativamente intensos incluso en espacios no protegidos frente a agentes abrasivos / Материалы рекомендованы для относительно сильного абразивного воздействия, в том числе в помещениях, не защищенных от царапающих элементов

PEZZI SPECIALI / TRIMS / SPEZIALTEILE / PIÈCES SPÉCIALES / PIEZAS ESPECIALES / СПЕЦИАЛЬНЫЕ ИЗДЕЛИЯ

Tutti i pezzi speciali sono su richiesta e sono coordinabili ai fondi rettificati. Gli imballi vengono calcolati sulla base del quantitativo ordinato / All special pieces are supplied to order and can be matched with the rectified plain tiles. Packaging is calculated on the basis of the quantity ordered / Alle Formteile sind auf Anfrage erhältlich und mit den rektifizierten Grundfliesen kombinierbar. Die Verpackung wird auf der Grundlage der Bestellmenge berechnet / Toutes les pièces spéciales sont fabriquées sur demande et coordonnables aux fonds rectifiés. Les emballages sont calculés en fonction de la quantité commandée / Todas las piezas especiales se entregan bajo pedido y se pueden coordinar con los fondos rectificados. Los embalajes se calculan según las cantidades encargadas en los pedidos / Все специальные изделия производятся на заказ и сочетаются с обрезной фоновой плиткой. Упаковки рассчитываются на основе заказанного количества

Gradone / Step tile, Elemento Elle / L-edging tile, Bordo U / U-edging tile, Cordolo L / L-kerb tile, Canalina / Gutter tile

Assemblato / Two-piece L-tile / Randstein zweiteilig / Assemblé / Montado / Собранный

CONSIGLI DI POSA / INSTALLATION ADVICE / HINWEISE ZUR VERLEGUNG / CONSEILS DE POSE / SUGERENCIAS PARA LA COLOCACIÓN / РЕКОМЕНДАЦИИ ПО УКЛАДКЕ

Per le pavimentazioni esterne non protette, Ragno consiglia di creare una pendenza  $\geq 1,5\%$  sulla superficie calpestabile allo scopo di limitare il formarsi di ristagni d'acqua localizzati. Nel caso in cui questi ristagni permangano sulla superficie delle piastrelle nonostante una posa a regola d'arte, è necessario intervenire meccanicamente con l'utilizzo di scope o aspira-liquidi / For unprotected outdoor pavings, Ragno recommends the creation of a gradient of  $\geq 1.5\%$  on the finished surface, to prevent the formation of patches of standing water. In the event that standing water persists on the surface of the tiles in spite of correct installation, it must be removed mechanically with the aid of brooms or wet-and-dry vacuum cleaners / Zur Unterbindung von punktueller Stauwasserbildung bei Belägen in ungeschützten Außenbereichen, empfiehlt die Ragno die Ausbildung eines Gefälles  $\geq 1,5\%$  auf der Trittlfläche. Sollte trotz fachgerechter Verlegung Stauwasser auf der Fliesenoberfläche zurückbleiben, ist dessen mechanische Entfernung mit Hilfe eines Besens oder Nasssaugers erforderlich / Pour des sols extérieurs non protégés, Ragno conseille de créer une inclinaison  $\geq 1,5\%$  sur la surface de piétinement en vue de limiter la stagnation localisée de l'eau. Si, malgré une pose dans les règles de l'art, cette stagnation devait persister à la surface des carreaux, une intervention mécanique, au moyen de balais et d'aspirateurs de liquides, est alors nécessaire / En el caso de pavimentaciones exteriores no protegidas, Ragno recomienda crear una pendiente  $\geq 1,5\%$  en la superficie transitable para limitar la formación de depósitos localizados de agua estancada. En caso de que estos depósitos de agua permanezcan en la superficie del azulejo, aun cuando la colocación se haya realizado correctamente, será necesario intervenir mecánicamente empleando un cepillo o un aspirador de líquidos / Для наружных незащищенных полов Ragno рекомендует создавать уклон  $\geq 1,5\%$  на пешеходной поверхности для снижения образования локальных застоев воды. В случае, если застои воды образуются на плитке несмотря на правильную укладку, необходимо прибегать к использованию механических средств, таких как щетки или же аппараты для сбора жидкостей

	GRADONE STEP TILE 30x60	GRADONE STEP TILE 30x60	GRADONE STEP TILE 30x60	GRADONE STEP TILE 30x60	ALZATA RISER TILE 20x60	ALZATA RISER TILE 20x60	ALZATA RISER TILE 20x60
LAVORAZIONE LATI TAGLIO + ASSEMBLAGGIO EDGES PRODUCED BY CUTTING + ASSEMBLY	SOLO SU LATO LUNGO ON LONG SIDE ONLY	LATO LUNGO + SX LONG SIDE + L	LATO LUNGO + DX LONG SIDE + R	LATO LUNGO + DX + SX LONG SIDE + R + L	NESSUN LATO LAVORATO NO SHAPED EDGES	ENTRAMBI I LATI CORTI BOTH SHORT SIDES	DX/SX RIBALTABILE R/L REVERSIBLE
Beige	R5ZV	R5ZY	R601	R604	R609	R60D	R60G
Grigio	R5ZU	R5ZX	R600	R603	R608	R60C	R60F
Antracite	R5ZW	R5ZZ	R602	R605	R60A	R60E	R60H
	COPRI MURETTO COPING TILE 30x60	COPRI MURETTO COPING TILE 30x60	ELEMENTO ELLE L-EDGING TILE 15x60x4	BORDO U U-EDGING TILE 15x60x15	CORDOLO L L-KERB TILE 15x60x20	CANALINA GUTTER TILE 15x60x8	GRIGLIA GRID TILE 15x60
LAVORAZIONE ROMPIGOCCIA NON-DRIP EDGE	SU 2 LATI LUNGI ON THE 2 LONG SIDES	SU 3 LATI ON 3 SIDES					
Beige	R60K	R60N	R5Z5	R60U	R60R	R610	R60X
Grigio	R60J	R60M	R5ZR	R60T	R60Q	R60Z	R60W
Antracite	R60L	R60P	R5ZT	R60V	R60S	R611	R60Y

CARATTERISTICHE / CHARACTERISTICS / EIGENSCHAFTEN / CARACTERISTIQUES / DATOS / ХАРАКТЕРИСТИКИ

R11	PENDULUM classe 3 p <sub>tv</sub> > 36	D-COF > 0,60	BCR $\mu > 0,40$
B			
	$\leq 175 \text{ mm}^2$		

CERTIFICAZIONI / CERTIFICATIONS / ZERTIFIZIERUNGEN / CERTIFICACIONES / СЕРТИФИКАЦИИ



IMBALLI / PACKAGING / VERPACKUNGEN / EMBALLAGES / EMBALAJES / УПАКОВКИ

	scatole / box / karton / boîte / caja / коробк			pallet / pallet / palette / palette / pallet / поддон			
	□	M <sup>2</sup>	KG	□	M <sup>2</sup>	KG	± mm
60x60	2	0,72	33,78	32	23,04	1107,00	20



XT20

# Stoneway\_Barge Antica XT20



R46L Grigio Rettificato 60x60 - 23<sup>5/8</sup>" x 23<sup>5/8</sup>"



## Stoneway\_Barge Antica XT20

gres fine porcellanato colorato in massa / colorbody fine porcelain stoneware / durchgefärbtes feinsteinzeug in einem werkmaß / grès cérame fin coloré dans la masse / gres porcelánico fino coloreado en toda la masa / гомогенный мелкозернистый керамогранит

gruppo Bla UNI EN 14411\_G



outdoor

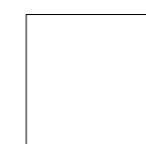

60x60 cm  
23<sup>5/8</sup>" x 23<sup>5/8</sup>"  
± 20 mm

STONE EFFECT  
Stoneway\_Barge Antica > p.188

# Stoneway\_Barge Antica XT20

60x60 - 23<sup>mm</sup> x 23<sup>mm</sup>

## Bianco



R46J 60x60 Rett



R46M 15x60 E.ELLE

## Grigio



R46L 60x60 Rett



R46P 15x60 E.ELLE

## Beige



R46K 60x60 Rett



R46N 15x60 E.ELLE

## TECH INFO

VARIAZIONI CROMATICHE / COLOUR VARIATIONS / FARBVARIATIONEN / VARIATIONS CHROMATIQUES / VARIACIONES CROMÁTICAS / ВАРИАНТЫ ОТТЕНКА



Variazioni irregolari da piastrella a piastrella. Una piastrella può differire totalmente nell'aspetto superficiale e colore da un'altra. Si consiglia di visionare la gamma cromatica prima della selezione del materiale / Random differences from tile to tile. One tile may have totally different texture and colour from another. The colour range should be viewed before selecting the material / Wesentliche Variationen von Fliese zu Fliese. Eine Fliese kann sich in Aussehen und Farbe komplett von einer anderen unterscheiden. Es wird empfohlen, das Farbsortiment vor der Auswahl des Materials zu prüfen / Variations irrégulières entre les carreaux. L'aspect et la couleur peuvent être complètement différents d'un carreau à l'autre. Il est recommandé de consulter la gamme des couleurs avant de sélectionner le matériel / Variaciones irregulares entre un azulejo y otro. Un azulejo puede ser completamente diferente de otro en el aspecto superficial y el color. Es aconsejable visualizar la gama cromática antes de seleccionar el material / Неоднородные изменения на разных плитках. Каждая плитка может полностью отличаться по виду поверхности и цвету от другой. Перед отбором материала рекомендуется посмотреть цветовую гамму

DESTINAZIONE D'USO / INTENDED USE / ANWENDUNGSBEREICH / CHAMP D'APPLICATION / USO PREVISTO / НАЗНАЧЕНИЕ

### H (Outdoor)

Materiali consigliati per sollecitazioni all'abrasione relativamente forti in ambienti anche non protetti da agenti graffianti / Materials recommended for relatively heavy abrasion levels, also in premises not protected against abrasive substances / Materials recommended for relatively heavy abrasion levels, also in premises not protected against abrasive substances / Empfohlen für starke Abriebbeanspruchungen in Bereichen auch ohne Kratzschutzbehandlung / Matériaux recommandés pour des locaux soumis à des fortes contraintes d'abrasion, même non protégés contre les agents abrasifs / Materiales recomendados para soportar esfuerzos de abrasión relativamente intensos incluso en espacios no protegidos frente a agentes abrasivos / Материалы рекомендованы для относительно сильного абразивного воздействия, в том числе в помещениях, не защищенных от царапающих элементов

PEZZI SPECIALI / TRIMS / SPEZIALTEILE / PIÈCES SPÉCIALES / PIEZAS ESPECIALES / СПЕЦИАЛЬНЫЕ ИЗДЕЛИЯ

### E.Elle

Elemento ad Elle tagliato ed assemblato / Two-piece l-tile / Randstein zweiteilig / Assemblé / Montado / Собранная

CONSIGLI DI POSA / INSTALLATION ADVICE / HINWEISE ZUR VERLEGUNG / CONSEILS DE POSE / SUGERENCIAS PARA LA COLOCACIÓN / РЕКОМЕНДАЦИИ ПО УКЛАДКЕ

Per le pavimentazioni esterne non protette, Ragno consiglia di creare una pendenza  $\geq 1,5\%$  sulla superficie calpestabile allo scopo di limitare il formarsi di ristagni d'acqua localizzati. Nel caso in cui questi ristagni permangano sulla superficie delle piastrelle nonostante una posa a regola d'arte, è necessario intervenire meccanicamente con l'utilizzo di scope o aspira-liquidi / For unprotected outdoor pavings, Ragno recommends the creation of a gradient of  $\geq 1.5\%$  on the finished surface, to prevent the formation of patches of standing water. In the event that standing water persists on the surface of the tiles in spite of correct installation, it must be removed mechanically with the aid of brooms or wet-and-dry vacuum cleaners / Zur Unterbindung von punktueller Stauwasserbildung bei Belägen in ungeschützten Außenbereichen, empfiehlt die Ragno die Ausbildung eines Gefälles  $\geq 1,5\%$  auf der Trittfäche. Sollte trotz fachgerechter Verlegung Stauwasser auf der Fliesenoberfläche zurückbleiben, ist dessen mechanische Entfernung mit Hilfe eines Besens oder Nasssaugers erforderlich / Pour des sols extérieurs non protégés, Ragno conseille de créer une inclinaison  $\geq 1,5\%$  sur la surface de piétinement en vue de limiter la stagnation localisée de l'eau. Si, malgré une pose dans les règles de l'art, cette stagnation devait persister à la surface des carreaux, une intervention mécanique, au moyen de balais et d'aspirateurs de liquides, est alors nécessaire / En el caso de pavimentaciones exteriores no protegidas, Ragno recomienda crear una pendiente  $\geq 1,5\%$  en la superficie transitabile para limitar la formación de depósitos localizados de agua estancada. En caso de que estos depósitos de agua permanezcan en la superficie del azulejo, aun cuando la colocación se haya realizado correctamente, será necesario intervenir mecánicamente empleando un cepillo o un aspirador de líquidos / Для наружных незащищенных полов Ragno рекомендует создавать уклон  $\geq 1,5\%$  на пешеходной поверхности для снижения образования локальных застоев воды. В случае, если застои воды образуются на плитке несмотря на правильную укладку, необходимо прибегать к использованию механических средств, таких как щетки или же аппараты для сбора жидкостей

CARATTERISTICHE / CHARACTERISTICS / EIGENSCHAFTEN / CARACTERISTIQUES / DATOS / ХАРАКТЕРИСТИКИ

	<b>R11</b>	<b>PENDULUM classe 3 p<sub>tv</sub> &gt; 36</b>	<b>D-COF &gt; 0,60</b>	<b>BCR <math>\mu &gt; 0,40</math></b>
	<b>B</b>			
	<b><math>\leq 175 \text{ mm}^2</math></b>			

CERTIFICAZIONI / CERTIFICATIONS / ZERTIFIZIERUNGEN / CERTIFICATIONS / CERTIFICACIONES / СЕРТИФИКАЦИИ



IMBALLI / PACKAGING / VERPACKUNGEN / EMBALLAGES / EMBALAJES / УПАКОВКИ

	scatole / box / karton / boîte / caja / короб			pallet / pallet / palette / palette / pallet / поддон			
		<b>M²</b>	<b>KG</b>		<b>M²</b>	<b>KG</b>	<b>± mm</b>
60x60	2	0,72	33,78	32	23,04	1107,00	20
15x60	E.ELLE 2	0,18	5,16	-	-	-	-

XT20

# Stoneway\_Porfido XT20



## Stoneway\_Porfido XT20

gres fine porcellanato colorato in massa / colorbody fine porcelain stoneware / durchgefärbtes feinsteinzeug in einem werkmaß / grès cérame fin coloré dans la masse / gres porcelánico fino coloreado en toda la masa / гомогенный мелкозернистый керамогранит

gruppo Bla UNI EN 14411\_G



outdoor

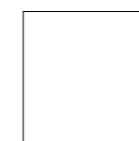

60x60 cm  
23<sup>5/8</sup>" x 23<sup>5/8</sup>"  
± 20 mm

R485 Anthracite Rettificato 60x60 - 23<sup>5/8</sup>" x 23<sup>5/8</sup>"

STONE EFFECT  
Stoneway\_Porfido > p.194

# Stoneway\_Porfido XT20

60x60 - 23<sup>mm</sup> x 23<sup>mm</sup>

## Beige



R48P 60x60 Rett

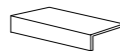

R48V 15x60 E.ELLE

## Rust



R48R 60x60 Rett



R48X 15x60 E.ELLE

## Anthracite



R48S 60x60 Rett



R48Y 15x60 E.ELLE

## TECH INFO

VARIAZIONI CROMATICHE / COLOUR VARIATIONS / FARBVARIATIONEN / VARIATIONS CHROMATIQUES / VARIACIONES CROMÁTICAS / ВАРИАНТЫ ОТТЕНКА



Significativa variazione di aspetto superficiale, grafica e colore da piastrella a piastrella e all'interno della stessa piastrella. Si consiglia di visionare la gamma cromatica prima della selezione del materiale / Significant variation in texture, pattern and colour from tile to tile within the same production run. The colour range should be viewed before selecting the material / Bedeutende Variation in Aussehen, Struktur und Farbe von Fliese zu Fliese und in ein und derselben Fliese. Es wird empfohlen, das Farbsortiment vor der Auswahl des Materials zu prüfen / Variation significative au niveau de l'aspect, de la fantaisie et de la couleur entre les carreaux et au sein d'un même carreau. Il est recommandé de consulter la gamme des couleurs avant de sélectionner le matériel / Variación considerable en el aspecto superficial, los motivos y el color entre un azulejo y otro y dentro del propio azulejo. Es aconsejable visualizar la gama cromática antes de seleccionar el material / Значительные отличия вида поверхности, графики и цвета у разных плиток и на одной и той же плитке. Перед отбором материала рекомендуется посмотреть цветовую гамму

DESTINAZIONE D'USO / INTENDED USE / ANWENDUNGSBEREICH / CHAMP D'APPLICATION / USO PREVISTO / НАЗНАЧЕНИЕ

### H (Outdoor)

Materiali consigliati per sollecitazioni all'abrasione relativamente forti in ambienti anche non protetti da agenti graffianti / Materials recommended for relatively heavy abrasion levels, also in premises not protected against abrasive substances / Materials recommended for relatively heavy abrasion levels, also in premises not protected against abrasive substances / Empfohlen für starke Abriebbeanspruchungen in Bereichen auch ohne Kratzschutzbehandlung / Matériaux recommandés pour des locaux soumis à des fortes contraintes d'abrasion, même non protégés contre les agents abrasifs / Materiales recomendados para soportar esfuerzos de abrasión relativamente intensos incluso en espacios no protegidos frente a agentes abrasivos / Материалы рекомендованы для относительно сильного абразивного воздействия, в том числе в помещениях, не защищенных от царапающих элементов

PEZZI SPECIALI / TRIMS / SPEZIALTEILE / PIÈCES SPÉCIALES / PIEZAS ESPECIALES / СПЕЦИАЛЬНЫЕ ИЗДЕЛИЯ

### E.Elle

Elemento ad Elle tagliato ed assemblato / Two-piece l-tile / Randstein zweiteilig / Assemblé / Montado / Собранная

CONSIGLI DI POSA / INSTALLATION ADVICE / HINWEISE ZUR VERLEGUNG / CONSEILS DE POSE / SUGERENCIAS PARA LA COLOCACIÓN / РЕКОМЕНДАЦИИ ПО УКЛАДКЕ

Per le pavimentazioni esterne non protette, Ragno consiglia di creare una pendenza  $\geq 1,5\%$  sulla superficie calpestabile allo scopo di limitare il formarsi di ristagni d'acqua localizzati. Nel caso in cui questi ristagni permangano sulla superficie delle piastrelle nonostante una posa a regola d'arte, è necessario intervenire meccanicamente con l'utilizzo di scope o aspira-liquidi / For unprotected outdoor pavings, Ragno recommends the creation of a gradient of  $\geq 1,5\%$  on the finished surface, to prevent the formation of patches of standing water. In the event that standing water persists on the surface of the tiles in spite of correct installation, it must be removed mechanically with the aid of brooms or wet-and-dry vacuum cleaners / Zur Unterbindung von punktueller Stauwasserbildung bei Belägen in ungeschützten Außenbereichen, empfiehlt die Ragno die Ausbildung eines Gefälles  $\geq 1,5\%$  auf der Trittfäche. Sollte trotz fachgerechter Verlegung Stauwasser auf der Fliesenoberfläche zurückbleiben, ist dessen mechanische Entfernung mit Hilfe eines Besens oder Nasssaugers erforderlich / Pour des sols extérieurs non protégés, Ragno conseille de créer une inclinaison  $\geq 1,5\%$  sur la surface de piétinement en vue de limiter la stagnation localisée de l'eau. Si, malgré une pose dans les règles de l'art, cette stagnation devait persister à la surface des carreaux, une intervention mécanique, au moyen de balais et d'aspirateurs de liquides, est alors nécessaire / En el caso de pavimentaciones exteriores no protegidas, Ragno recomienda crear una pendiente  $\geq 1,5\%$  en la superficie transitabile para limitar la formación de depósitos localizados de agua estancada. En caso de que estos depósitos de agua permanezcan en la superficie del azulejo, aun cuando la colocación se haya realizado correctamente, será necesario intervenir mecánicamente empleando un cepillo o un aspirador de líquidos / Для наружных незащищенных полов Ragno рекомендует создавать уклон  $\geq 1,5\%$  на пешеходной поверхности для снижения образования локальных застоев воды. В случае, если застои воды образуются на плитке несмотря на правильную укладку, необходимо прибегать к использованию механических средств, таких как щетки или же аппараты для сбора жидкостей

CARATTERISTICHE / CHARACTERISTICS / EIGENSCHAFTEN / CARACTERISTIQUES / DATOS / ХАРАКТЕРИСТИКИ

	<b>R11</b>	<b>PENDULUM classe 3</b> ptv > 36	<b>D-COF &gt; 0,60</b>	<b>BCR <math>\mu &gt; 0,40</math></b>
	<b>B</b>			
	<b><math>\leq 175 \text{ mm}^2</math></b>			

CERTIFICAZIONI / CERTIFICATIONS / ZERTIFIZIERUNGEN / CERTIFICATIONS / CERTIFICACIONES / СЕРТИФИКАЦИИ



IMBALLI / PACKAGING / VERPACKUNGEN / EMBALLAGES / EMBALAJES / УПАКОВКИ

	scatole / box / karton / boîte / caja / короб			pallet / pallet / palette / palette / pallet / поддон			
		<b>M²</b>	<b>KG</b>		<b>M²</b>	<b>KG</b>	<b>± mm</b>
60x60	2	0,72	33,65	32	23,04	1102,00	20
15x60	E.ELLE	2	0,18	5,16	-	-	-

XT20

# Woodsense XT20



**R7LC** Grigio Rettificato 40x120 - 15<sup>3/4</sup>"x47<sup>1/4</sup>" - **R7LH** Grigio Rettificato 60x60 - 23<sup>5/8</sup>"x23<sup>5/8</sup>"  
**R8ZW** Grigio Alzata 20x60 - 7<sup>7/8</sup>"x23<sup>5/8</sup>" - **R81W** Grigio Elemento Elle 15x60x4 - 5<sup>7/8</sup>"x23<sup>5/8</sup>"x1<sup>9/16</sup>"



## Woodsense XT20

gres fine porcellanato colorato in massa - rettificato monocalibro / colorbody fine porcelain stoneware - rectified monocaliber / durchgefärbtes feinsteinzeug - rektifiziert, in einem werkmaß / grès cérame fin coloré dans la masse - rectifié monocalibre / gres porcelánico fino coloreado en toda la masa - rectificado monocalibre / гомогенный мелкозернистый керамогранит - ректифицированный монокалиберный

gruppo Bla UNI EN 14411\_G



outdoor



**40x120 cm**  
 15<sup>3/4</sup>"x47<sup>1/4</sup>"  
 ± 20 mm

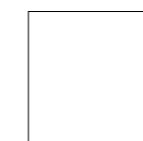

**60x60 cm**  
 23<sup>5/8</sup>"x23<sup>5/8</sup>"  
 ± 20 mm

**WOOD EFFECT**  
 Woodsense > p.282

# Woodsense XT20

40x120 - 15<sup>3/4</sup>"x47<sup>1/4</sup>" 60x60 - 23<sup>3/8</sup>"x23<sup>3/8</sup>"

## Beige



**R7L8** 40x120 Rett  
**R7LF** 60x60 Rett

## Marrone



**R7LA** 40x120 Rett  
**R7LG** 60x60 Rett

## Grigio



**R7LC** 40x120 Rett  
**R7LH** 60x60 Rett

## TECH INFO

VARIAZIONI CROMATICHE / COLOUR VARIATIONS / FARBVARIATIONEN / VARIATIONS CHROMATIQUES / VARIACIONES CROMÁTICAS / ВАРИАНТЫ ОТТЕНКА



Significativa variazione di aspetto superficiale, grafica e colore da piastrella a piastrella e all'interno della stessa piastrella. Si consiglia di visionare la gamma cromatica prima della selezione del materiale / Significant variation in texture, pattern and colour from tile to tile within the same production run. The colour range should be viewed before selecting the material / Bedeutende Variation in Aussehen, Struktur und Farbe von Fliese zu Fliese und in ein und derselben Fliese. Es wird empfohlen, das Farbsortiment vor der Auswahl des Materials zu prüfen / Variation significative au niveau de l'aspect, de la fantaisie et de la couleur entre les carreaux et au sein d'un même carreau. Il est recommandé de consulter la gamme des couleurs avant de sélectionner le matériel / Variación considerable en el aspecto superficial, los motivos y el color entre un azulejo y otro y dentro del propio azulejo. Es aconsejable visualizar la gama cromática antes de seleccionar el material / Значительные отличия вида поверхности, графики и цвета у разных плиток и на одной и той же плитке. Перед отбором материала рекомендуется посмотреть цветовую гамму

PEZZI SPECIALI / TRIMS / SPEZIALTEILE / PIÈCES SPÉCIALES / PIEZAS ESPECIALES / СПЕЦИАЛЬНЫЕ ИЗДЕЛИЯ

Tutti i pezzi speciali sono su richiesta e sono coordinabili ai fondi rettificati. Gli imballi vengono calcolati sulla base del quantitativo ordinato / All special pieces are supplied to order and can be matched with the rectified plain tiles. Packaging is calculated on the basis of the quantity ordered / Alle Formteile sind auf Anfrage erhältlich und mit den rektifizierten Grundfliesen kombinierbar. Die Verpackung wird auf der Grundlage der Bestellmenge berechnet / Toutes les pièces spéciales sont fabriquées sur demande et coordonnables aux fonds rectifiés. Les emballages sont calculés en fonction de la quantité commandée / Todas las piezas especiales se entregan bajo pedido y se pueden coordinar con los fondos rectificados. Los embalajes se calculan según las cantidades encargadas en los pedidos / Все специальные изделия производятся на заказ и сочетаются с обрезной фоновой плиткой. Упаковки рассчитываются на основе заказанного количества

**Gradone / Step tile, Elemento Elle / L-edging tile, Bordo U / U-edging tile, Cordolo L / L-kerb tile, Canalina / Gutter tile**

Assemblato / Two-piece L-tile / Randstein zweiteilig / Assemblé / Montado / Собранный

DESTINAZIONE D'USO / INTENDED USE / ANWENDUNGSBEREICH / CHAMP D'APPLICATION / USO PREVISTO / НАЗНАЧЕНИЕ

### H (Outdoor)

Materiali consigliati per sollecitazioni all'abrasione relativamente forti in ambienti anche non protetti da agenti graffianti / Materials recommended for relatively heavy abrasion levels, also in premises not protected against abrasive substances / Materials recommended for relatively heavy abrasion levels, also in premises not protected against abrasive substances / Empfohlen für starke Abriebbeanspruchungen in Bereichen auch ohne Kratzschutzbehandlung / Matériaux recommandés pour des locaux soumis à des fortes contraintes d'abrasion, même non protégés contre les agents abrasifs / Materiales recomendados para soportar esfuerzos de abrasión relativamente intensos incluso en espacios no protegidos frente a agentes abrasivos / Материалы рекомендованы для относительно сильного абразивного воздействия, в том числе в помещениях, не защищенных от царапающих элементов

CONSIGLI DI POSA / INSTALLATION ADVICE / HINWEISE ZUR VERLEGUNG / CONSEILS DE POSE / SUGERENCIAS PARA LA COLOCACIÓN / РЕКОМЕНДАЦИИ ПО УКЛАДКЕ

Per le pavimentazioni esterne non protette, Ragno consiglia di creare una pendenza ≥ 1,5% sulla superficie calpestabile allo scopo di limitare il formarsi di ristagni d'acqua localizzati. Nel caso in cui questi ristagni permangano sulla superficie delle piastrelle nonostante una posa a regola d'arte, è necessario intervenire meccanicamente con l'utilizzo di scope o aspira-liquidi / For unprotected outdoor pavings, Ragno recommends the creation of a gradient of ≥ 1.5% on the finished surface, to prevent the formation of patches of standing water. In the event that standing water persists on the surface of the tiles in spite of correct installation, it must be removed mechanically with the aid of brooms or wet-and-dry vacuum cleaners / Zur Unterbindung von punktueller Stauwasserbildung bei Belägen in ungeschützten Außenbereichen, empfiehlt die Ragno die Ausbildung eines Gefälles ≥ 1,5% auf der Trittlfläche. Sollte trotz fachgerechter Verlegung Stauwasser auf der Fliesenoberfläche zurückbleiben, ist dessen mechanische Entfernung mit Hilfe eines Besens oder Nasssaugers erforderlich / Pour des sols extérieurs non protégés, Ragno conseille de créer une inclinaison ≥ 1,5 % sur la surface de piétinement en vue de limiter la stagnation localisée de l'eau. Si, malgré une pose dans les règles de l'art, cette stagnation devait persister à la surface des carreaux, une intervention mécanique, au moyen de balais et d'aspirateurs de liquides, est alors nécessaire / En el caso de pavimentaciones exteriores no protegidas, Ragno recomienda crear una pendiente ≥ 1,5% en la superficie transitabile para limitar la formación de depósitos localizados de agua estancada. En caso de que estos depósitos de agua permanezcan en la superficie del azulejo, aun cuando la colocación se haya realizado correctamente, será necesario intervenir mecánicamente empleando un cepillo o un aspirador de líquidos / Для наружных незащищенных полов Ragno рекомендует создавать уклон ≥ 1,5% на пешеходной поверхности для снижения образования локальных застоев воды. В случае, если застои воды образуются на плитке несмотря на правильную укладку, необходимо прибегать к использованию механических средств, таких как щетки или же аппараты для сбора жидкостей

LAVORAZIONE LATI TAGLIO • ASSEMBLAGGIO EDGES PRODUCED BY CUTTING • ASSEMBLY	SOLO SU LATO LUNGO ON LONG SIDE ONLY	LATO LUNGO • SX LONG SIDE • L	LATO LUNGO • DX LONG SIDE • R	LATO LUNGO • DX • SX LONG SIDE • R • L	SOLO SU LATO LUNGO ON LONG SIDE ONLY	LATO LUNGO • SX LONG SIDE • L	LATO LUNGO • DX LONG SIDE • R	LATO LUNGO • DX • SX LONG SIDE • R • L	SOLO SU LATO LUNGO ON LONG SIDE ONLY
<b>Beige</b>	<b>R81Y</b>	<b>R82G</b>	<b>R82L</b>	<b>R82Q</b>	<b>R88J</b>	<b>R88N</b>	<b>R88W</b>	<b>R891</b>	<b>R9FM</b>
<b>Marrone</b>	<b>R822</b>	<b>R82H</b>	<b>R82M</b>	<b>R82R</b>	<b>R88K</b>	<b>R88P</b>	<b>R88X</b>	<b>R894</b>	<b>R9FN</b>
<b>Grigio</b>	<b>R82A</b>	<b>R82J</b>	<b>R82N</b>	<b>R82S</b>	<b>R88L</b>	<b>R88Q</b>	<b>R88Y</b>	<b>R895</b>	<b>R9FP</b>

LAVORAZIONE LATI EDGE SHAPING	NESSUN LATO LAVORATO NO SHAPED EDGES	ENTRambi I LATI CORTI BOTH SHORT SIDES	DX/SX RIBALTABILE R/L REVERSIBLE	NESSUN LATO LAVORATO NO SHAPED EDGES	ENTRambi I LATI CORTI BOTH SHORT SIDES	DX/SX RIBALTABILE R/L REVERSIBLE
<b>Beige</b>	<b>R82U</b>	<b>R83R</b>	<b>R84K</b>	<b>R899</b>	<b>R89E</b>	<b>R8AS</b>
<b>Marrone</b>	<b>R82V</b>	<b>R83T</b>	<b>R84L</b>	<b>R89A</b>	<b>R89F</b>	<b>R8AT</b>
<b>Grigio</b>	<b>R82W</b>	<b>R83U</b>	<b>R84M</b>	<b>R89C</b>	<b>R89G</b>	<b>R8AW</b>

LAVORAZIONE ROMPIGOCCIA NON-DRIP EDGE	SU 2 LATI LUNGH ON THE 2 LONG SIDES	SU 3 LATI ON 3 SIDES	SU 2 LATI LUNGH ON THE 2 LONG SIDES	SU 3 LATI ON 3 SIDES
<b>Beige</b>	<b>R87J</b>	<b>R84P</b>	<b>R89S</b>	<b>R89N</b>
<b>Marrone</b>	<b>R87K</b>	<b>R84Q</b>	<b>R89T</b>	<b>R89P</b>
<b>Grigio</b>	<b>R87L</b>	<b>R84R</b>	<b>R89U</b>	<b>R89Q</b>

LAVORAZIONE ROMPIGOCCIA NON-DRIP EDGE	SU 2 LATI LUNGH ON THE 2 LONG SIDES	SU 3 LATI ON 3 SIDES	SU 2 LATI LUNGH ON THE 2 LONG SIDES	SU 3 LATI ON 3 SIDES
<b>Beige</b>	<b>R87J</b>	<b>R84P</b>	<b>R89S</b>	<b>R89N</b>
<b>Marrone</b>	<b>R87K</b>	<b>R84Q</b>	<b>R89T</b>	<b>R89P</b>
<b>Grigio</b>	<b>R87L</b>	<b>R84R</b>	<b>R89U</b>	<b>R89Q</b>

CARATTERISTICHE / CHARACTERISTICS / EIGENSCHAFTEN / CARACTERISTIQUES / DATOS / ХАРАКТЕРИСТИКИ

CERTIFICAZIONI / CERTIFICATIONS / ZERTIFIZIERUNGEN / CERTIFICATIONS / CERTIFICACIONES / СЕРТИФИКАЦИИ

	<b>R11</b>	<b>PENDULUM classe 3 ptv &gt; 36</b>	<b>D-COF &gt; 0,60</b>	<b>BCR μ &gt; 0,40</b>
	<b>B</b>			
	<b>≤ 175 mm<sup>2</sup></b>			



IMBALLI / PACKAGING / VERPACKUNGEN / EMBALLAGES / EMBALAJES / УПАКОВКИ

	scatole / box / karton / boîte / caja / короб			pallet / pallet / palette / palette / pallet / поддон			
	□	M <sup>2</sup>	KG	□	M <sup>2</sup>	KG	± mm
40x120	1	0,48	22,00	48	23,04	1055,90	20
60x60	2	0,72	34,26	32	23,04	1096,15	20

XT20

# Woodliving XT20



R4RE Rovere Biondo Rettificato 40x120 - 15<sup>3/4</sup>"x47<sup>1/4</sup>"



## Woodliving XT20

gres fine porcellanato colorato in massa - rettificato monocalibro / colorbody fine porcelain stoneware - rectified monocaliber / durchgefärbtes feinsteinzeug - rektifiziert, in einem werkmaß / grès cérame fin coloré dans la masse - rectifié monocalibre / gres porcelánico fino coloreado en toda la masa - rectificado monocalibre / гомогенный мелкозернистый керамогранит - ректифицированный монокалиберный

gruppo Bla UNI EN 14411\_G



outdoor



40x120 cm  
15<sup>3/4</sup>"x47<sup>1/4</sup>"  
± 20 mm

WOOD EFFECT  
Woodliving > p.286

# Woodliving XT20

40x120 - 15<sup>3/4</sup> x 47<sup>1/4</sup>

## Rovere Biondo



R4RE 40x120 Rett

## Rovere Scuro



R4RF 40x120 Rett

## Rovere Fumo



R4RH 40x120 Rett

## TECH INFO

VARIAZIONI CROMATICHE / COLOUR VARIATIONS / FARBVARIATIONEN / VARIATIONS CHROMATIQUES / VARIACIONES CROMÁTICAS / ВАРИАНТЫ ОТТЕНКА



Apprezzabili differenze nell'aspetto di superficie e grafica all'interno della stessa produzione / Clearly distinguishable differences in texture and pattern within the same production run / Auffällige Unterschiede in Aussehen und Struktur innerhalb der gleichen Produktionscharge / Différences visibles au niveau de l'aspect et de la fantaisie entre les carreaux du même lot de production / Diferencias visibles en el aspecto de la superficie y los motivos dentro de un mismo lote de producción / заметные отличия вида поверхности и графики в одной и той же партии

DESTINAZIONE D'USO / INTENDED USE / ANWENDUNGSBEREICH / CHAMP D'APPLICATION / USO PREVISTO / НАЗНАЧЕНИЕ

### G (Rovere Fumo: Outdoor)

Materiali consigliati per locali sottoposti a sollecitazioni all'abrasione medio pesanti come: case individuali, commerciale leggero / Materials recommended for premises with medium-heavy abrasion levels, such as: detached homes, light-traffic commercial premises / Empfohlen für Räume mit mittelschwerer Abriebbeanspruchung wie: Einfamilienhäuser, leicht beanspruchte Gewerbebereiche / Matériaux recommandés pour des locaux soumis à des contraintes d'abrasion moyennes et fortes comme : maisons particulières, espaces commerciaux soumis à un trafic léger, etc / Materiales recomendados para locales sometidos a esfuerzos de abrasión medio-pesados, como casas unifamiliares y locales comerciales de tráfico ligero / Материалы рекомендованы для использования в частных домах и коммерческих помещениях, подверженных средне-сильному абразивному воздействию

### H (Rovere Biondo, Rovere Scuro: Outdoor)

Materiali consigliati per sollecitazioni all'abrasione relativamente forti in ambienti anche non protetti da agenti graffianti / Materials recommended for relatively heavy abrasion levels, also in premises not protected against abrasive substances / Materials recommended for relatively heavy abrasion levels, also in premises not protected against abrasive substances / Empfohlen für starke Abriebbeanspruchungen in Bereichen auch ohne Kratzschutzbehandlung / Matériaux recommandés pour des locaux soumis à des fortes contraintes d'abrasion, même non protégés contre les agents abrasifs / Materiales recomendados para soportar esfuerzos de abrasión relativamente intensos incluso en espacios no protegidos frente a agentes abrasivos / Материалы рекомендованы для относительно сильного абразивного воздействия, в том числе в помещениях, не защищенных от царапающих элементов

PEZZI SPECIALI / TRIMS / SPEZIALTEILE / PIÈCES SPÉCIALES / PIEZAS ESPECIALES / СПЕЦИАЛЬНЫЕ ИЗДЕЛИЯ

Tutti i pezzi speciali sono su richiesta e sono coordinabili ai fondi rettificati. Gli imballi vengono calcolati sulla base del quantitativo ordinato / All special pieces are supplied to order and can be matched with the rectified plain tiles. Packaging is calculated on the basis of the quantity ordered / Alle Formteile sind auf Anfrage erhältlich und mit den rektifizierten Grundfliesen kombinierbar. Die Verpackung wird auf der Grundlage der Bestellmenge berechnet / Toutes les pièces spéciales sont fabriquées sur demande et coordonnables aux fonds rectifiés. Les emballages sont calculés en fonction de la quantité commandée / Todas las piezas especiales se entregan bajo pedido y se pueden coordinar con los fondos rectificados. Los embalajes se calculan según las cantidades encargadas en los pedidos / Все специальные изделия производятся на заказ и сочетаются с обрезной фоновой плиткой. Упаковки рассчитываются на основе заказанного количества

### Gradone / Step tile, Elemento Elle / L-edging tile, Bordo U / U-edging tile, Cordolo L / L-kerb tile, Canalina / Gutter tile

Assemblato / Two-piece L-tile / Randstein zweiteilig / Assemblé / Montado / Собранный

### CONSIGLI DI POSA / INSTALLATION ADVICE / HINWEISE ZUR VERLEGUNG / CONSEILS DE POSE / SUGERENCIAS PARA LA COLOCACIÓN / РЕКОМЕНДАЦИИ ПО УКЛАДКЕ

Per le pavimentazioni esterne non protette, Ragno consiglia di creare una pendenza  $\geq 1,5\%$  sulla superficie calpestabile allo scopo di limitare il formarsi di ristagni d'acqua localizzati. Nel caso in cui questi ristagni permangano sulla superficie delle piastrelle nonostante una posa a regola d'arte, è necessario intervenire meccanicamente con l'utilizzo di scope o aspira-liquidi / For unprotected outdoor pavings, Ragno recommends the creation of a gradient of  $\geq 1.5\%$  on the finished surface, to prevent the formation of patches of standing water. In the event that standing water persists on the surface of the tiles in spite of correct installation, it must be removed mechanically with the aid of brooms or wet-and-dry vacuum cleaners / Zur Unterbindung von punktueller Stauwasserbildung bei Belägen in ungeschützten Außenbereichen, empfiehlt die Ragno die Ausbildung eines Gefälles  $\geq 1,5\%$  auf der Trittlfläche. Sollte trotz fachgerechter Verlegung Stauwasser auf der Fliesenoberfläche zurückbleiben, ist dessen mechanische Entfernung mit Hilfe eines Besens oder Nasssaugers erforderlich / Pour des sols extérieurs non protégés, Ragno conseille de créer une inclinaison  $\geq 1,5\%$  sur la surface de piétinement en vue de limiter la stagnation localisée de l'eau. Si, malgré une pose dans les règles de l'art, cette stagnation devait persister à la surface des carreaux, une intervention mécanique, au moyen de balais et d'aspirateurs de liquides, est alors nécessaire / En el caso de pavimentaciones exteriores no protegidas, Ragno recomienda crear una pendiente  $\geq 1,5\%$  en la superficie transitabile para limitar la formación de depósitos localizados de agua estancada. En caso de que estos depósitos de agua permanezcan en la superficie del azulejo, aun cuando la colocación se haya realizado correctamente, será necesario intervenir mecánicamente empleando un cepillo o un aspirador de líquidos / Для наружных незащищенных полов Ragno рекомендует создавать уклон  $\geq 1,5\%$  на пешеходной поверхности для снижения образования локальных застоев воды. В случае, если застои воды образуются на плитке несмотря на правильную укладку, необходимо прибегать к использованию механических средств, таких как щетки или же аппараты для сбора жидкостей

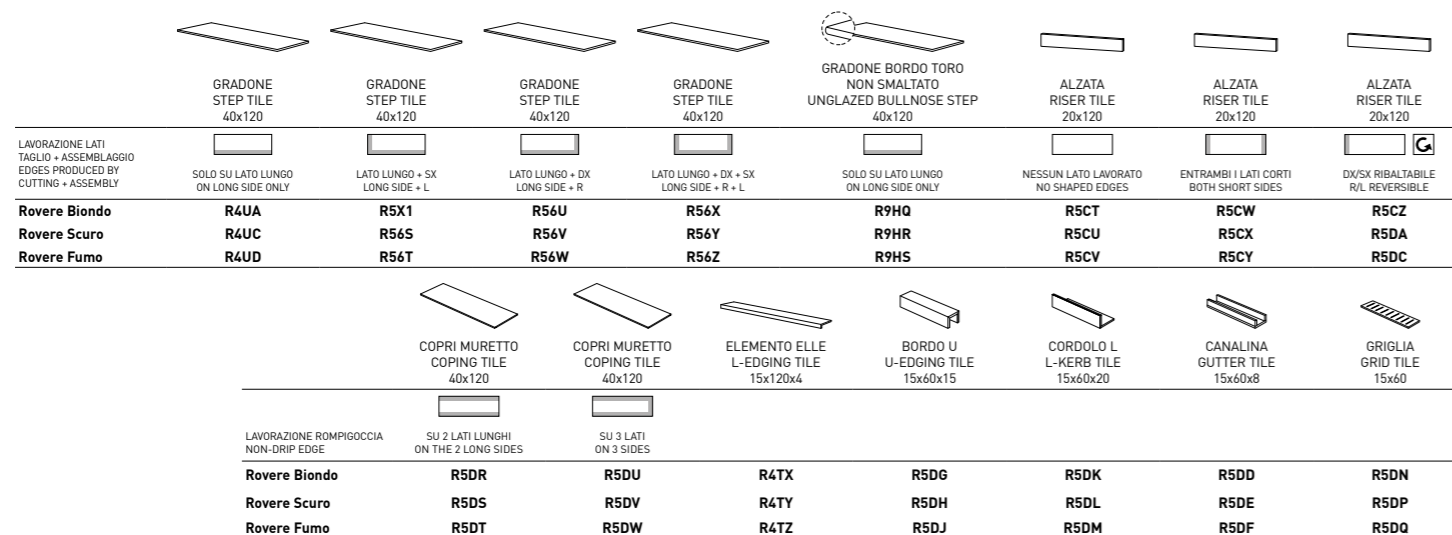

CARATTERISTICHE / CHARACTERISTICS / EIGENSCHAFTEN / CARACTERISTIQUES / DATOS / ХАРАКТЕРИСТИКИ

	<b>R11</b>	<b>PENDULUM classe 3 pTV &gt; 36</b>	<b>D-COF &gt; 0,60</b>	<b>BCR <math>\mu &gt; 0,40</math></b>
	<b>B</b>			
	<b><math>\leq 175 \text{ mm}^2</math></b>			

CERTIFICAZIONI / CERTIFICATIONS / ZERTIFIZIERUNGEN / CERTIFICATIONS / CERTIFICACIONES / СЕРТИФИКАЦИИ



IMBALLI / PACKAGING / VERPACKUNGEN / EMBALLAGES / EMBALAJES / УПАКОВКИ

	scatole / box / karton / boîte / caja / короб			pallet / pallet / palette / palette / pallet / поддон			
		M <sup>2</sup>	KG		M <sup>2</sup>	KG	mm
40x120	1	0,48	22,10	48	23,04	1060,50	20
40x120	SC	1	0,48	22,64	-	-	-



XT20

# Woodtale XT20



R51V Betulla Rettificato 40x120 - 15<sup>3/4</sup>"x47<sup>1/4</sup>"



## Woodtale XT20

gres fine porcellanato colorato in massa - rettificato monocalibro / colorbody fine porcelain stoneware - rectified monocaliber / durchgefärbtes feinsteinzeug - rektifiziert, in einem werkmaß / grès cérame fin coloré dans la masse - rectifié monocalibre / gres porcelánico fino coloreado en toda la masa - rectificado monocalibre / гомогенный мелкозернистый керамогранит - ректифицированный монокалиберный

gruppo Bia UNI EN 14411\_G



outdoor



40x120 cm  
15<sup>3/4</sup>"x47<sup>1/4</sup>"  
± 20 mm

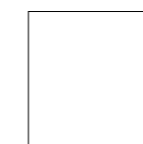

60x60 cm  
23<sup>5/8</sup>"x23<sup>5/8</sup>"  
± 20 mm

WOOD EFFECT  
Woodtale > p.292

# Woodtale XT20

40x120 - 15<sup>3/4</sup>"x47<sup>1/4</sup>" 60x60 - 23<sup>5/8</sup>"x23<sup>5/8</sup>"

## Betulla



**R51V** 40x120 Rett  
**R4XF** 60x60 Rett

## Miele



**R51W** 40x120 Rett  
**R4XG** 60x60 Rett

## Nocciola



**R51X** 40x120 Rett  
**R4XH** 60x60 Rett

## Noce



**R51Y** 40x120 Rett  
**R4XJ** 60x60 Rett

## TECH INFO

VARIAZIONI CROMATICHE / COLOUR VARIATIONS / FARBVARIATIONEN / VARIATIONS CHROMATIQUES / VARIACIONES CROMÁTICAS / ВАРИАНТЫ ОТТЕНКА



Significativa variazione di aspetto superficiale, grafica e colore da piastrella a piastrella e all'interno della stessa piastrella. Si consiglia di visionare la gamma cromatica prima della selezione del materiale / Significant variation in texture, pattern and colour from tile to tile within the same production run. The colour range should be viewed before selecting the material / Bedeutende Variation in Aussehen, Struktur und Farbe von Fliese zu Fliese und in ein und derselben Fliese. Es wird empfohlen, das Farbsortiment vor der Auswahl des Materials zu prüfen / Variation significative au niveau de l'aspect, de la fantaisie et de la couleur entre les carreaux et au sein d'un même carreau. Il est recommandé de consulter la gamme des couleurs avant de sélectionner le matériel / Variación considerable en el aspecto superficial, los motivos y el color entre un azulejo y otro y dentro del propio azulejo. Es aconsejable visualizar la gama cromática antes de seleccionar el material / Значительные отличия вида поверхности, графики и цвета у разных плиток и на одной и той же плитке. Перед отбором материала рекомендуется посмотреть цветовую гамму

DESTINAZIONE D'USO / INTENDED USE / ANWENDUNGSBEREICH / CHAMP D'APPLICATION / USO PREVISTO / НАЗНАЧЕНИЕ

### H (Outdoor)

Materiali consigliati per sollecitazioni all'abrasione relativamente forti in ambienti anche non protetti da agenti graffianti / Materials recommended for relatively heavy abrasion levels, also in premises not protected against abrasive substances / Materials recommended for relatively heavy abrasion levels, also in premises not protected against abrasive substances / Empfohlen für starke Abriebbeanspruchungen in Bereichen auch ohne Kratzschutzbehandlung / Matériaux recommandés pour des locaux soumis à des fortes contraintes d'abrasion, même non protégés contre les agents abrasifs / Materiales recomendados para soportar esfuerzos de abrasión relativamente intensos incluso en espacios no protegidos frente a agentes abrasivos / Материалы рекомендованы для относительно сильного абразивного воздействия, в том числе в помещениях, не защищенных от царапающих элементов

PEZZI SPECIALI / TRIMS / SPEZIALTEILE / PIÈCES SPÉCIALES / PIEZAS ESPECIALES / СПЕЦИАЛЬНЫЕ ИЗДЕЛИЯ

Tutti i pezzi speciali sono su richiesta e sono coordinabili ai fondi rettificati. Gli imballi vengono calcolati sulla base del quantitativo ordinato / All special pieces are supplied to order and can be matched with the rectified plain tiles. Packaging is calculated on the basis of the quantity ordered / Alle Formteile sind auf Anfrage erhältlich und mit den rektifizierten Grundfliesen kombinierbar. Die Verpackung wird auf der Grundlage der Bestellmenge berechnet / Toutes les pièces spéciales sont fabriquées sur demande et coordonnables aux fonds rectifiés. Les emballages sont calculés en fonction de la quantité commandée / Todas las piezas especiales se entregan bajo pedido y se pueden coordinar con los fondos rectificados. Los embalajes se calculan según las cantidades encargadas en los pedidos / Все специальные изделия производятся на заказ и сочетаются с обрезной фоновой плиткой. Упаковки рассчитываются на основе заказанного количества

Gradone / Step tile, Elemento Elle / L-edging tile, Bordo U / U-edging tile, Cordolo L / L-kerb tile, Canalina / Gutter tile

Assemblato / Two-piece L-tile / Randstein zweiteilig / Assemblé / Montado / Собранный

CONSIGLI DI POSA / INSTALLATION ADVICE / HINWEISE ZUR VERLEGUNG / CONSEILS DE POSE / SUGERENCIAS PARA LA COLOCACIÓN / РЕКОМЕНДАЦИИ ПО УКЛАДКЕ

Per le pavimentazioni esterne non protette, Ragno consiglia di creare una pendenza ≥ 1,5% sulla superficie calpestabile allo scopo di limitare il formarsi di ristagni d'acqua localizzati. Nel caso in cui questi ristagni permangano sulla superficie delle piastrelle nonostante una posa a regola d'arte, è necessario intervenire meccanicamente con l'utilizzo di scope o aspira-liquidi / For unprotected outdoor pavings, Ragno recommends the creation of a gradient of ≥ 1.5% on the finished surface, to prevent the formation of patches of standing water. In the event that standing water persists on the surface of the tiles in spite of correct installation, it must be removed mechanically with the aid of brooms or wet-and-dry vacuum cleaners / Zur Unterbindung von punktueller Stauwasserbildung bei Belägen in ungeschützten Außenbereichen, empfiehlt die Ragno die Ausbildung eines Gefälles ≥ 1,5% auf der Trittlfläche. Sollte trotz fachgerechter Verlegung Stauwasser auf der Fliesenoberfläche zurückbleiben, ist dessen mechanische Entfernung mit Hilfe eines Besens oder Nasssaugers erforderlich / Pour des sols extérieurs non protégés, Ragno conseille de créer une inclinaison ≥ 1,5 % sur la surface de piétinement en vue de limiter la stagnation localisée de l'eau. Si, malgré une pose dans les règles de l'art, cette stagnation devait persister à la surface des carreaux, une intervention mécanique, au moyen de balais et d'aspirateurs de liquides, est alors nécessaire / En el caso de pavimentaciones exteriores no protegidas, Ragno recomienda crear una pendiente ≥ 1,5% en la superficie transitable para limitar la formación de depósitos localizados de agua estancada. En caso de que estos depósitos de agua permanezcan en la superficie del azulejo, aun cuando la colocación se haya realizado correctamente, será necesario intervenir mecánicamente empleando un cepillo o un aspirador de líquidos / Для наружных незащищенных полов Ragno рекомендует создавать уклон ≥ 1,5% на пешеходной поверхности для снижения образования локальных застоев воды. В случае, если застои воды образуются на плитке несмотря на правильную укладку, необходимо прибегать к использованию механических средств, таких как щетки или же аппараты для сбора жидкостей

	GRADONE STEP TILE 30x60	GRADONE STEP TILE 30x60	GRADONE STEP TILE 30x60	GRADONE STEP TILE 30x60	GRADONE STEP TILE 40x120	GRADONE STEP TILE 40x120	GRADONE STEP TILE 40x120	GRADONE STEP TILE 40x120	GRADONE BORDO TORO NON SMALTATO UNGLAZED BULLNOSE STEP 40x120	
LAVORAZIONE LATI TAGLIO + ASSEMBLAGGIO EDGES PRODUCED BY CUTTING + ASSEMBLY	SOLO SU LATO LUNGO ON LONG SIDE ONLY	LATO LUNGO + SX LONG SIDE + L	LATO LUNGO + DX LONG SIDE + R	LATO LUNGO + DX + SX LONG SIDE + R + L	SOLO SU LATO LUNGO ON LONG SIDE ONLY	LATO LUNGO + SX LONG SIDE + L	LATO LUNGO + DX LONG SIDE + R	LATO LUNGO + DX + SX LONG SIDE + R + L	SOLO SU LATO LUNGO ON LONG SIDE ONLY	
<b>Betulla</b>	R5EC	R5EG	R5EL	R5EQ	R5GJ	R5GN	R5GS	R5GW	R9FR	
<b>Miele</b>	R5ED	R5EH	R5EM	R5ER	R5GK	R5GP	R5GT	R5GX	R9FS	
<b>Nocciola</b>	R5EE	R5EJ	R5EN	R5ES	R5GL	R5GQ	R5GU	R5GY	R9FT	
<b>Noce</b>	R5EF	R5EK	R5EP	R5ET	R5GM	R5GR	R5GV	R5GZ	R9FU	
		ALZATA RISER TILE 20x60	ALZATA RISER TILE 20x60	ALZATA RISER TILE 20x60	ALZATA RISER TILE 20x120	ALZATA RISER TILE 20x120	ALZATA RISER TILE 20x120	ALZATA RISER TILE 20x120	ALZATA RISER TILE 20x120	
LAVORAZIONE LATI EDGE SHAPING	NESSUN LATO LAVORATO NO SHAPED EDGES	ENTRambi I LATI CORTI BOTH SHORT SIDES	DX/SX RIBALTABILE R/L REVERSIBLE	NESSUN LATO LAVORATO NO SHAPED EDGES	ENTRambi I LATI CORTI BOTH SHORT SIDES	DX/SX RIBALTABILE R/L REVERSIBLE	NESSUN LATO LAVORATO NO SHAPED EDGES	ENTRambi I LATI CORTI BOTH SHORT SIDES	DX/SX RIBALTABILE R/L REVERSIBLE	
<b>Betulla</b>	R5EU	R5EY	R5FH	R5HA	R5HF	R5HK	R5HC	R5HG	R5HL	
<b>Miele</b>	R5EV	R5EZ	R5FE	R5HD	R5HH	R5YL	R5HE	R5HJ	R5X7	
<b>Nocciola</b>	R5EW	R5FA	R5FF	R5HE	R5HJ	R5X7				
<b>Noce</b>	R5EX	R5FC	R5FG							
	COPRI MURETTO COPING TILE 30x60	COPRI MURETTO COPING TILE 30x60	COPRI MURETTO COPING TILE 40x120	COPRI MURETTO COPING TILE 40x120	ELEMENTO ELLE L-EDGING TILE 15x60x4	ELEMENTO ELLE L-EDGING TILE 15x120x4	BORDO U U-EDGING TILE 15x60x15	CORDOLO L L-KERB TILE 15x60x20	CANALINA GUTTER TILE 15x60x8	GRIGLIA GRID TILE 15x60
LAVORAZIONE ROMPIGOCCIA NON-DRIP EDGE	SU 2 LATI LUNGHY ON THE 2 LONG SIDES	SU 3 LATI ON 3 SIDES	SU 2 LATI LUNGHY ON THE 2 LONG SIDES	SU 3 LATI ON 3 SIDES						
<b>Betulla</b>	R5FZ	R5GE	R63D	R6KM	R4XK	R70D	R5FM	R5FR	R5FH	R5FV
<b>Miele</b>	R5GA	R5GF	R58N	R57P	R4XL	R5YC	R5FN	R5FS	R5FJ	R5FW
<b>Nocciola</b>	R5GC	R5GG	R6UN	R68F	R4XM	R5UM	R5FP	R5FT	R5FK	R5FX
<b>Noce</b>	R5GD	R5GH	R61A	R5WV	R4XN	R6VR	R5FQ	R5FU	R5FL	R5FY

CARATTERISTICHE / CHARACTERISTICS / EIGENSCHAFTEN / CARACTERISTIQUES / DATOS / ХАРАКТЕРИСТИКИ

	<b>R11</b>	PENDULUM classe 3 p <sub>tv</sub> > 36	D-COF > 0,60	BCR μ > 0,40
	<b>B</b>			
		≤ 175 mm <sup>3</sup>		

CERTIFICAZIONI / CERTIFICATIONS / ZERTIFIZIERUNGEN / CERTIFICACIONES / СЕРТИФИКАЦИИ



IMBALLI / PACKAGING / VERPACKUNGEN / EMBALLAGES / EMBALAJES / УПАКОВКИ

	scatole / box / karton / boîte / caja / короб				pallet / pallet / palette / palette / pallet / поддон			
	□	M²	KG		□	M²	KG	± mm
40x120	1	0,48	22,10		48	23,04	1060,50	20
60x60	2	0,72	34,26		32	23,04	1096,15	20
15x60x4	2	0,18	5,61	E.ELLE	-	-	-	-

XT20

# Woodmania XT20



R5TR Honey Rettificato 40x120 - 15<sup>3/4</sup>"x47<sup>1/4</sup>"



## Woodmania XT20

gres fine porcellanato colorato in massa - rettificato monocalibro / colorbody fine porcelain stoneware - rectified monocaliber / durchgefärbtes feinsteinzeug - rektifiziert, in einem werkmaß / grès cérame fin coloré dans la masse - rectifié monocalibre / gres porcelánico fino coloreado en toda la masa - rectificado monocalibre / гомогенный мелкозернистый керамогранит - ректифицированный монокалиберный

gruppo Bia UNI EN 14411\_G



outdoor



40x120 cm  
15<sup>3/4</sup>"x47<sup>1/4</sup>"  
± 20 mm

WOOD EFFECT  
Woodmania > p.298

# Woodmania XT20

40x120 - 15<sup>3/4</sup> x 47<sup>1/4</sup>

## Honey



R5TR 40x120 Rett

## Caramel



R5TS 40x120 Rett

## Musk



R5TT 40x120 Rett

## TECH INFO

VARIAZIONI CROMATICHE / COLOUR VARIATIONS / FARBVARIATIONEN / VARIATIONS CHROMATIQUES / VARIACIONES CROMÁTICAS / ВАРИАНТЫ ОТТЕНКА



Variazioni irregolari da piastrella a piastrella. Una piastrella può differire totalmente nell'aspetto superficiale e colore da un'altra. Si consiglia di visionare la gamma cromatica prima della selezione del materiale / Random differences from tile to tile. One tile may have totally different texture and colour from another. The colour range should be viewed before selecting the material / Wesentliche Variationen von Fliese zu Fliese. Eine Fliese kann sich in Aussehen und Farbe komplett von einer anderen unterscheiden. Es wird empfohlen, das Farbsortiment vor der Auswahl des Materials zu prüfen / Variations irrégulières entre les carreaux. L'aspect et la couleur peuvent être complètement différents d'un carreau à l'autre. Il est recommandé de consulter la gamme des couleurs avant de sélectionner le matériel / Variaciones irregulares entre un azulejo y otro. Un azulejo puede ser completamente diferente de otro en el aspecto superficial y el color. Es aconsejable visualizar la gama cromática antes de seleccionar el material / Неоднородные изменения на разных плитках. Каждая плитка может полностью отличаться по виду поверхности и цвету от другой. Перед отбором материала рекомендуется посмотреть цветовую гамму

PEZZI SPECIALI / TRIMS / SPEZIALTEILE / PIÈCES SPÉCIALES / PIEZAS ESPECIALES / СПЕЦИАЛЬНЫЕ ИЗДЕЛИЯ

Tutti i pezzi speciali sono su richiesta e sono coordinabili ai fondi rettificati. Gli imballi vengono calcolati sulla base del quantitativo ordinato / All special pieces are supplied to order and can be matched with the rectified plain tiles. Packaging is calculated on the basis of the quantity ordered / Alle Formteile sind auf Anfrage erhältlich und mit den rektifizierten Grundfliesen kombinierbar. Die Verpackung wird auf der Grundlage der Bestellmenge berechnet / Toutes les pièces spéciales sont fabriquées sur demande et coordonnables aux fonds rectifiés. Les emballages sont calculés en fonction de la quantité commandée / Todas las piezas especiales se entregan bajo pedido y se pueden coordinar con los fondos rectificados. Los embalajes se calculan según las cantidades encargadas en los pedidos / Все специальные изделия производятся на заказ и сочетаются с обрезной фоновой плиткой. Упаковки рассчитываются на основе заказанного количества

Gradone / Step tile, Elemento Elle / L-edging tile, Bordo U / U-edging tile, Cordolo L / L-kerb tile, Canalina / Gutter tile

Assemblato / Two-piece L-tile / Randstein zweiteilig / Assemblé / Montado / Собранный

CONSIGLI DI POSA / INSTALLATION ADVICE / HINWEISE ZUR VERLEGUNG / CONSEILS DE POSE / SUGERENCIAS PARA LA COLOCACIÓN / РЕКОМЕНДАЦИИ ПО УКЛАДКЕ

Per le pavimentazioni esterne non protette, Ragno consiglia di creare una pendenza ≥ 1,5% sulla superficie calpestabile allo scopo di limitare il formarsi di ristagni d'acqua localizzati. Nel caso in cui questi ristagni permangano sulla superficie delle piastrelle nonostante una posa a regola d'arte, è necessario intervenire meccanicamente con l'utilizzo di scope o aspira-liquidi / For unprotected outdoor pavings, Ragno recommends the creation of a gradient of ≥ 1.5% on the finished surface, to prevent the formation of patches of standing water. In the event that standing water persists on the surface of the tiles in spite of correct installation, it must be removed mechanically with the aid of brooms or wet-and-dry vacuum cleaners / Zur Unterbindung von punktueller Stauwasserbildung bei Belägen in ungeschützten Außenbereichen, empfiehlt die Ragno die Ausbildung eines Gefälles ≥ 1,5% auf der Trittlfläche. Sollte trotz fachgerechter Verlegung Stauwasser auf der Fliesenoberfläche zurückbleiben, ist dessen mechanische Entfernung mit Hilfe eines Besens oder Nasssaugers erforderlich / Pour des sols extérieurs non protégés, Ragno conseille de créer une inclinaison ≥ 1,5 % sur la surface de piétinement en vue de limiter la stagnation localisée de l'eau. Si, malgré une pose dans les règles de l'art, cette stagnation devait persister à la surface des carreaux, une intervention mécanique, au moyen de balais et d'aspirateurs de liquides, est alors nécessaire / En el caso de pavimentaciones exteriores no protegidas, Ragno recomienda crear una pendiente ≥ 1,5% en la superficie transitable para limitar la formación de depósitos localizados de agua estancada. En caso de que estos depósitos de agua permanezcan en la superficie del azulejo, aun cuando la colocación se haya realizado correctamente, será necesario intervenir mecánicamente empleando un cepillo o un aspirador de líquidos / Для наружных незащищенных полов Ragno рекомендует создавать уклон ≥ 1,5% на пешеходной поверхности для снижения образования локальных застоев воды. В случае, если застои воды образуются на плитке несмотря на правильную укладку, необходимо прибегать к использованию механических средств, таких как щетки или же аппараты для сбора жидкостей

DESTINAZIONE D'USO / INTENDED USE / ANWENDUNGSBEREICH / CHAMP D'APPLICATION / USO PREVISTO / НАЗНАЧЕНИЕ

G (Caramel, Musk: Outdoor)

Materiali consigliati per locali sottoposti a sollecitazioni all'abrasione medio pesanti come: case individuali, commerciale leggero / Materials recommended for premises with medium-heavy abrasion levels, such as: detached homes, light-traffic commercial premises / Empfohlen für Räume mit mittelschwerer Abriebbeanspruchung wie: Einfamilienhäuser, leicht beanspruchte Gewerbebereiche / Matériaux recommandés pour des locaux soumis à des contraintes d'abrasion moyennes et fortes comme : maisons particulières, espaces commerciaux soumis à un trafic léger, etc / Materiales recomendados para locales sometidos a esfuerzos de abrasión medio-pesados, como casas unifamiliares y locales comerciales de tráfico ligero / Материалы рекомендованы для использования в частных домах и коммерческих помещениях, подверженных средне-сильному абразивному воздействию

H (Honey: Outdoor)

Materiali consigliati per sollecitazioni all'abrasione relativamente forti in ambienti anche non protetti da agenti graffianti / Materials recommended for relatively heavy abrasion levels, also in premises not protected against abrasive substances / Materials recommended for relatively heavy abrasion levels, also in premises not protected against abrasive substances / Empfohlen für starke Abriebbeanspruchungen in Bereichen auch ohne Kratzschutzbehandlung / Matériaux recommandés pour des locaux soumis à des fortes contraintes d'abrasion, même non protégés contre les agents abrasifs / Materiales recomendados para soportar esfuerzos de abrasión relativamente intensos incluso en espacios no protegidos frente a agentes abrasivos / Материалы рекомендованы для относительно сильного абразивного воздействия, в том числе в помещениях, не защищенных от царапающих элементов

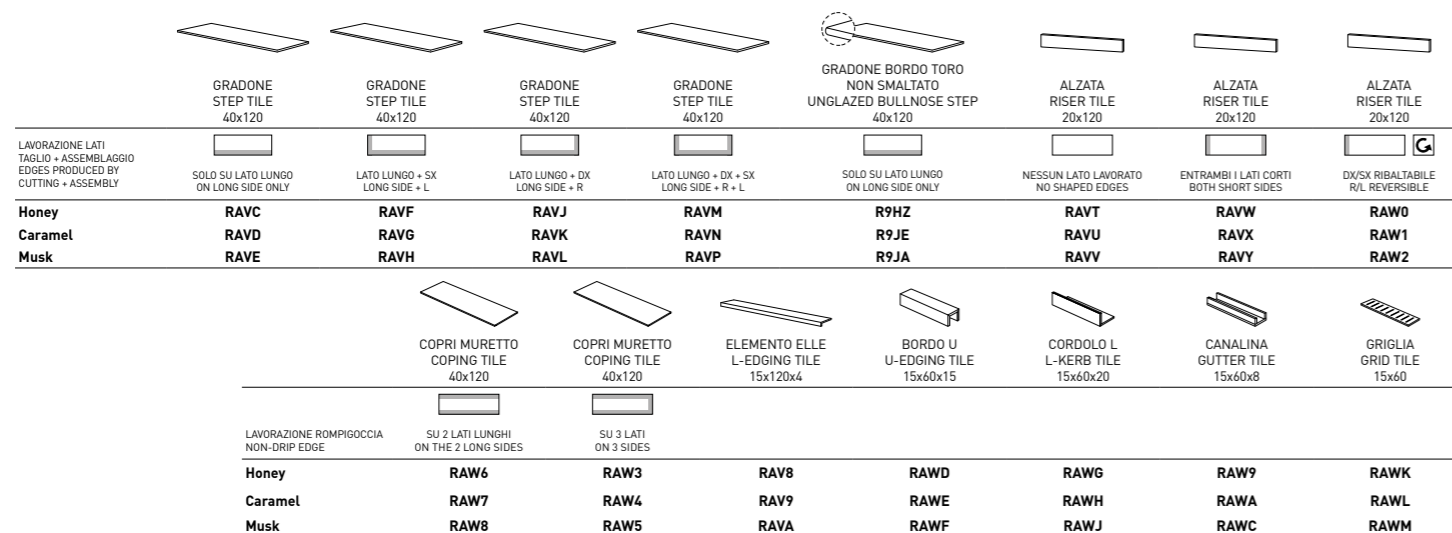

CARATTERISTICHE / CHARACTERISTICS / EIGENSCHAFTEN / CARACTERISTIQUES / DATOS / ХАРАКТЕРИСТИКИ

	R11	PENDULUM classe 3 p <sub>tv</sub> > 36	D-COF > 0,60	BCR μ > 0,40
	B			
	≤ 175 mm <sup>2</sup>			

CERTIFICAZIONI / CERTIFICATIONS / ZERTIFIZIERUNGEN / CERTIFICACIONES / СЕРТИФИКАЦИИ



IMBALLI / PACKAGING / VERPACKUNGEN / EMBALLAGES / EMBALAJES / УПАКОВКИ

	scatole / box / karton / boîte / caja / коробк			pallet / pallet / palette / palette / pallet / поддон		
	□	M <sup>2</sup>	KG	□	M <sup>2</sup>	KG
40x120	1	0,48	22,99	48	23,04	1103,26
						± mm

XT20

# Stratford XT20



STRATFORD XT20 | XT20

R96T Beige Rettificato 60x120 - 23<sup>5/8</sup> x 47<sup>1/4</sup>"



STRATFORD XT20 | XT20

## Stratford XT20

gres fine porcellanato colorato in massa - rettificato monocalibro / colorbody fine porcelain stoneware - rectified monocaliber / durchgefärbtes feinsteinzeug - rektifiziert, in einem werkmaß / grès cérame fin coloré dans la masse - rectifié monocalibre / gres porcelánico fino coloreado en toda la masa - rectificado monocalibre / гомогенный мелкозернистый керамогранит - ректифицированный монокалиберный

gruppo Bia UNI EN 14411\_G

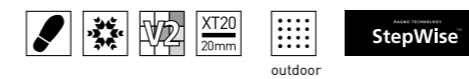

outdoor



60x120 cm  
23<sup>5/8</sup> x 47<sup>1/4</sup>"  
± 20 mm

CONCRETE EFFECT  
Stratford > p.210

# Stratford XT20

60x120 - 23<sup>5/8</sup> x 47<sup>1/4</sup>"

White



R96V 60x120 Rett

Clay



R96U 60x120 Rett

Grey



R96W 60x120 Rett

Beige



R96T 60x120 Rett









Dark Grey









R96X 60x120 Rett

STRATFORD XT20 | XT20

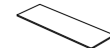
STRATFORD XT20 | XT20

								
	GRADONE STEP TILE 40x120	GRADONE STEP TILE 40x120	GRADONE STEP TILE 40x120	GRADONE STEP TILE 40x120	GRADONE BORDO TORO NON SMALTATO UNGLAZED BULLNOSE STEP 60x120	ALZATA RISER TILE 20x120	ALZATA RISER TILE 20x120	ALZATA RISER TILE 20x120
LAVORAZIONE LATI TAGLIO + ASSEMBLAGGIO EDGES PRODUCED BY CUTTING + ASSEMBLY	SOLO SU LATO LUNGO ON LONG SIDE ONLY	LATO LUNGO + SX LONG SIDE + L	LATO LUNGO + DX LONG SIDE + R	LATO LUNGO + DX + SX LONG SIDE + R + L	SOLO SU LATO LUNGO ON LONG SIDE ONLY	NESSUN LATO LAVORATO NO SHAPED EDGES	ENTRAMBI I LATI CORTI BOTH SHORT SIDES	DX/SX RIBALTABILE R/L REVERSIBLE
White	R98D	R98K	R97W	R97N	R96D	R99E	R98X	R98R
Grey	R98H	R98N	R97Z	R97U	R96G	R99H	R99A	R98U
Dark Grey	R98G	R98P	R98A	R97T	R96H	R99J	R99C	R98V
Clay	R98E	R98L	R97X	R97Q	R96E	R99F	R98Y	R98S
Beige	R98F	R98M	R97Y	R97S	R96F	R99G	R98Z	R98T

							
	COPRI MURETTO COPING TILE 40x120	COPRI MURETTO COPING TILE 40x120	ELEMENTO ELLE L-EDGING TILE 15x120x4	BORDO U U-EDGING TILE 15x60x15	CORDOLO L L-KERB TILE 15x60x20	CANALINA GUTTER TILE 15x60x8	GRIGLIA GRID TILE 15x60
LAVORAZIONE ROMPIGOCCIA NON-DRIP EDGE	SU 2 LATI LUNGHICI ON THE 2 LONG SIDES	SU 3 LATI ON 3 SIDES					
White	R99L	R99S	R97J	R9AG	R99Z	R9AN	R9AU
Grey	R99P	R99U	R97K	R9AK	R9AD	R9AR	R9AX
Dark Grey	R99D	R99V	R97L	R9AL	R9AE	R9AS	R9AY
Clay	R99M	R99T	R97H	R9AH	R9AA	R9AP	R9AV
Beige	R99N	R99X	R97G	R9AJ	R9AC	R9AQ	R9AW

# Stratford XT20



STRATFORD XT20 | XT20

STRATFORD XT20 | XT20

R96W Grey Rettificato 60x120 - 23<sup>5/8</sup>"x47<sup>1/4</sup>"

## TECH INFO

VARIAZIONI CROMATICHE / COLOUR VARIATIONS / FARBVARIATIONEN / VARIATIONS CHROMATIQUES / VARIACIONES CROMÁTICAS / ВАРИАНТЫ ОТТЕНКА



Apprezzabili differenze nell'aspetto di superficie e grafica all'interno della stessa produzione / Clearly distinguishable differences in texture and pattern within the same production run / Auffällige Unterschiede in Aussehen und Struktur innerhalb der gleichen Produktionscharge / Différences visibles au niveau de l'aspect et de la fantaisie entre les carreaux du même lot de production / Diferencias visibles en el aspecto de la superficie y los motivos dentro de un mismo lote de producción / заметные отличия вида поверхности и графики в одной и той же партии

DESTINAZIONE D'USO / INTENDED USE / ANWENDUNGSBEREICH / CHAMP D'APPLICATION / USO PREVISTO / НАЗНАЧЕНИЕ

### H (Outdoor)

Materiali consigliati per sollecitazioni all'abrasione relativamente forti in ambienti anche non protetti da agenti graffianti / Materials recommended for relatively heavy abrasion levels, also in premises not protected against abrasive substances / Materials recommended for relatively heavy abrasion levels, also in premises not protected against abrasive substances / Empfohlen für starke Abriebbeanspruchungen in Bereichen auch ohne Kratzschutzbehandlung / Matériaux recommandés pour des locaux soumis à des fortes contraintes d'abrasion, même non protégés contre les agents abrasifs / Materiales recomendados para soportar esfuerzos de abrasión relativamente intensos incluso en espacios no protegidos frente a agentes abrasivos / Материалы рекомендованы для относительно сильного абразивного воздействия, в том числе в помещениях, не защищенных от царапающих элементов

PEZZI SPECIALI / TRIMS / SPEZIALTEILE / PIÈCES SPÉCIALES / PIEZAS ESPECIALES / СПЕЦИАЛЬНЫЕ ИЗДЕЛИЯ

Tutti i pezzi speciali sono su richiesta e sono coordinabili ai fondi rettificati. Gli imballi vengono calcolati sulla base del quantitativo ordinato / All special pieces are supplied to order and can be matched with the rectified plain tiles. Packaging is calculated on the basis of the quantity ordered / Alle Formteile sind auf Anfrage erhältlich und mit den rektifizierten Grundfliesen kombinierbar. Die Verpackung wird auf der Grundlage der Bestellmenge berechnet / Toutes les pièces spéciales sont fabriquées sur demande et coordonnables aux fonds rectifiés. Les emballages sont calculés en fonction de la quantité commandée / Todas las piezas especiales se entregan bajo pedido y se pueden coordinar con los fondos rectificadas. Los embalajes se calculan según las cantidades encargadas en los pedidos / Все специальные изделия производятся на заказ и сочетаются с обрезной фоновой плиткой. Упаковки рассчитываются на основе заказанного количества

Gradone / Step tile, Elemento Elle / L-edging tile, Bordo U / U-edging tile, Cordolo L / L-kerb tile, Canalina / Gutter tile

Assemblato / Two-piece l-tile / Randstein zweiteilig / Assemblé / Montado / Собранный

CONSIGLI DI POSA / INSTALLATION ADVICE / HINWEISE ZUR VERLEGUNG / CONSEILS DE POSE / SUGERENCIAS PARA LA COLOCACIÓN / РЕКОМЕНДАЦИИ ПО УКЛАДКЕ

Per le pavimentazioni esterne non protette, Ragno consiglia di creare una pendenza  $\geq 1,5\%$  sulla superficie calpestabile allo scopo di limitare il formarsi di ristagni d'acqua localizzati. Nel caso in cui questi ristagni permangano sulla superficie delle piastrelle nonostante una posa a regola d'arte, è necessario intervenire meccanicamente con l'utilizzo di scope o aspira-liquidi / For unprotected outdoor pavings, Ragno recommends the creation of a gradient of  $\geq 1.5\%$  on the finished surface, to prevent the formation of patches of standing water. In the event that standing water persists on the surface of the tiles in spite of correct installation, it must be removed mechanically with the aid of brooms or wet-and-dry vacuum cleaners / Zur Unterbindung von punktueller Stauwasserbildung bei Belägen in ungeschützten Außenbereichen, empfiehlt die Ragno die Ausbildung eines Gefälles  $\geq 1,5\%$  auf der Trittlfläche. Sollte trotz fachgerechter Verlegung Stauwasser auf der Fliesenoberfläche zurückbleiben, ist dessen mechanische Entfernung mit Hilfe eines Besens oder Nasssaugers erforderlich / Pour des sols extérieurs non protégés, Ragno conseille de créer une inclinaison  $\geq 1,5\%$  sur la surface de piétinement en vue de limiter la stagnation localisée de l'eau. Si, malgré une pose dans les règles de l'art, cette stagnation devait persister à la surface des carreaux, une intervention mécanique, au moyen de balais et d'aspirateurs de liquides, est alors nécessaire / En el caso de pavimentaciones exteriores no protegidas, Ragno recomienda crear una pendiente  $\geq 1,5\%$  en la superficie transitable para limitar la formación de depósitos localizados de agua estancada. En caso de que estos depósitos de agua permanezcan en la superficie del azulejo, aun cuando la colocación se haya realizado correctamente, será necesario intervenir mecánicamente empleando un cepillo o un aspirador de líquidos / Для наружных незащищенных полов Ragno рекомендует создавать уклон  $\geq 1,5\%$  на пешеходной поверхности для снижения образования локальных застоев воды. В случае, если застои воды образуются на плитке несмотря на правильную укладку, необходимо прибегать к использованию механических средств, таких как щетки или же аппараты для сбора жидкостей

TECNOLOGIE / TECHNOLOGIES / TECHNOLOGIEN / TECHNOLOGIES / TECNOLOGÍAS / ТЕХНОЛОГИИ

### StepWise

Le piastrelle realizzate con questa nuova tecnologia sono caratterizzate da un'elevata resistenza allo scivolamento e da una superficie morbida al tatto e facile da pulire, data l'assenza di ruvidità superficiale / The tiles produced using this new technology have a high degree of slip resistance and a surface which is soft to the touch and easy to clean, since it has no superficial roughness / Les carreaux utilisant cette nouvelle technologie de production se distinguent par une très grande résistance à la glissance et par une surface douce au toucher et facile à nettoyer puisqu'elle ne présente aucune rugosité / Mit dieser neuen Technologie hergestellte Fliesen zeichnen sich durch eine hohe Rutschhemmung, eine weiche Haptik und eine einfache Reinigung aufgrund der fehlenden Oberflächenrauheit aus / Los azulejos fabricados aplicando esta nueva tecnología se caracterizan por su elevada resistencia al deslizamiento y por presentar una superficie suave al tacto y fácil de limpiar, dada la nula aspereza de su superficie / Произведенная по этой новой технологии плитка обладает высокой стойкостью к скольжению и мягкой на ощупь, легко очищающейся поверхностью, что обеспечивается отсутствием шероховатости на поверхности

CARATTERISTICHE / CHARACTERISTICS / EIGENSCHAFTEN / CARACTERISTIQUES / DATOS / ХАРАКТЕРИСТИКИ

	R11	PENDULUM classe 3 p <sub>tv</sub> > 36	D-COF > 0,60	BCR $\mu > 0,40$
	C			
		$\leq 175 \text{ mm}^2$		

IMBALLI / PACKAGING / VERPACKUNGEN / EMBALLAGES / EMBALAJES / УПАКОВКИ

	scatole / box / karton / boîte / caja / коробк			pallet / pallet / palette / palette / pallet / поддон			
	□	M <sup>2</sup>	KG	□	M <sup>2</sup>	KG	± mm
60x120	1	0,72	35,00	36	25,92	1260,00	20

XT20

# Patina XT20



PATINA XT20 | XT20

PATINA XT20 | XT20



## Patina XT20

gres fine porcellanato colorato in massa - rettificato monocalibro / colorbody fine porcelain stoneware - rectified monocaliber / durchgefärbtes feinsteinzeug - rektifiziert, in einem werkmaß / grès cérame fin coloré dans la masse - rectifié monocalibre / gres porcelánico fino coloreado en toda la masa - rectificado monocalibre / гомогенный мелкозернистый керамогранит - ректифицированный монокалиберный

gruppo Bla UNI EN 14411\_G



outdoor



80x80 cm  
31 1/2" x 31 1/2"  
± 20 mm

RAWQ Asfalto Rettificato 80x80 - 31 1/2" x 31 1/2" - RAWX Asfalto Elemento Elle 15x80x4 - 5 7/8" x 31 1/2" x 1 9/16"

CONCRETE EFFECT  
Patina > p.232



# Patina XT20

80x80 - 31<sup>1/2</sup> x 31<sup>1/2</sup>

## Crema



RAWN 80x80 Rett

## Cognac



RAWP 80x80 Rett

## Asfalto

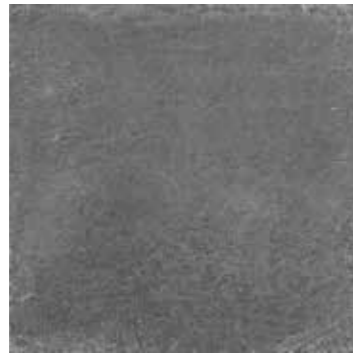

RAWQ 80x80 Rett

## Petrolio

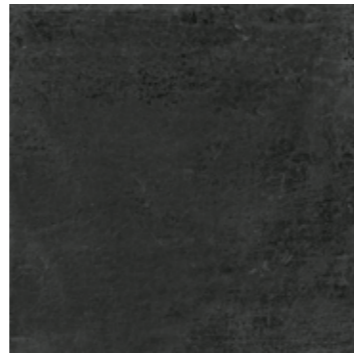

RAWR 80x80 Rett

## TECH INFO

VARIAZIONI CROMATICHE / COLOUR VARIATIONS / FARBVARIATIONEN / VARIATIONS CHROMATIQUES / VARIACIONES CROMÁTICAS / ВАРИАНТЫ ОТТЕНКА



Apprezzabili differenze nell'aspetto di superficie e grafica all'interno della stessa produzione / Clearly distinguishable differences in texture and pattern within the same production run / Auffällige Unterschiede in Aussehen und Struktur innerhalb der gleichen Produktionscharge / Différences visibles au niveau de l'aspect et de la fantaisie entre les carreaux du même lot de production / Diferencias visibles en el aspecto de la superficie y los motivos dentro de un mismo lote de producción / заметные отличия вида поверхности и графики в одной и той же партии

DESTINAZIONE D'USO / INTENDED USE / ANWENDUNGSBEREICH / CHAMP D'APPLICATION / USO PREVISTO / НАЗНАЧЕНИЕ

### H [Outdoor]

Materiali consigliati per sollecitazioni all'abrasione relativamente forti in ambienti anche non protetti da agenti graffianti / Materials recommended for relatively heavy abrasion levels, also in premises not protected against abrasive substances / Materials recommended for relatively heavy abrasion levels, also in premises not protected against abrasive substances / Empfohlen für starke Abriebbeanspruchungen in Bereichen auch ohne Kratzschutzbehandlung / Matériaux recommandés pour des locaux soumis à des fortes contraintes d'abrasion, même non protégés contre les agents abrasifs / Materiales recomendados para soportar esfuerzos de abrasión relativamente intensos incluso en espacios no protegidos frente a agentes abrasivos / Материалы рекомендованы для относительно сильного абразивного воздействия, в том числе в помещениях, не защищенных от царапающих элементов

PEZZI SPECIALI / TRIMS / SPEZIALTEILE / PIÈCES SPÉCIALES / PIEZAS ESPECIALES / СПЕЦИАЛЬНЫЕ ИЗДЕЛИЯ

Tutti i pezzi speciali sono su richiesta e sono coordinabili ai fondi rettificati. Gli imballi vengono calcolati sulla base del quantitativo ordinato / All special pieces are supplied to order and can be matched with the rectified plain tiles. Packaging is calculated on the basis of the quantity ordered / Alle Formteile sind auf Anfrage erhältlich und mit den rektifizierten Grundfliesen kombinierbar. Die Verpackung wird auf der Grundlage der Bestellmenge berechnet / Toutes les pièces spéciales sont fabriquées sur demande et coordonnables aux fonds rectifiés. Les emballages sont calculés en fonction de la quantité commandée / Todas las piezas especiales se entregan bajo pedido y se pueden coordinar con los fondos rectificadas. Los embalajes se calculan según las cantidades encargadas en los pedidos / Все специальные изделия производятся на заказ и сочетаются с обрезной фоновой плиткой. Упаковки рассчитываются на основе заказанного количества

Gradone / Step tile, Elemento Elle / L-edging tile, Bordo U / U-edging tile, Cordolo L / L-kerb tile, Canalina / Gutter tile

Assemblato / Two-piece l-tile / Randstein zweiteilig / Assemblé / Montado / Собранный

	GRADONE STEP TILE 40x80	GRADONE STEP TILE 40x80	GRADONE STEP TILE 40x80	GRADONE STEP TILE 40x80	GRADONE BORDO TORO NON SMALTATO UNGLAZED BULLNOSE STEP 40x80	ALZATA RISER TILE 20x80	ALZATA RISER TILE 20x80	ALZATA RISER TILE 20x80
LAVORAZIONE LATI TABLIO + ASSEMBLAGGIO EDGES PRODUCED BY CUTTING + ASSEMBLY	SOLO SU LATO LUNGO ON LONG SIDE ONLY	LATO LUNGO + SX LONG SIDE + L	LATO LUNGO + DX LONG SIDE + R	LATO LUNGO + SX LONG SIDE + R + L	SOLO SU LATO LUNGO ON LONG SIDE ONLY	NESSUN LATO LAVORATO NO SHAPED EDGES	ENTRAMBI I LATI CORTI BOTH SHORT SIDES	DX/SX RIBALTABILE R/L REVERSIBLE
Crema	RAWZ	RAX3	RAX7	RAXC	R9G6	RAXG	RAXL	RAXQ
Cognac	RAX0	RAX4	RAX8	RAXD	R9G7	RAXH	RAXM	RAXR
Asfalto	RAX1	RAX5	RAX9	RAXE	R9G8	RAXJ	RAXN	RAXS
Petrolio	RAX2	RAX6	RAXA	RAXF	R9GA	RAXK	RAXP	RAXT
	COPRI MURETTO COPING TILE 40x80	COPRI MURETTO COPING TILE 40x80	ELEMENTO ELLE L-EDGING TILE 15x80x4	BORDO U U-EDGING TILE 15x80x15	CORDOLO L L-KERB TILE 15x80x20	CANALINA GUTTER TILE 15x80x8	GRIGLIA GRID TILE 15x80	
LAVORAZIONE BOMPISGOCCIA NON-D RIP EDGE	SU 2 LATI LUNGI ON THE 2 LONG SIDES	SU 3 LATI ON 3 SIDES						
Crema	RAXY	RAXU	RAWW	RAY6	RAY2	RAYF	RAYA	
Cognac	RAXZ	RAXV	RAWX	RAY7	RAY3	RAYG	RAYC	
Asfalto	RAY0	RAXW	RAWY	RAY8	RAY4	RAYH	RAYD	
Petrolio	RAY1	RAXX	RAWY	RAY9	RAY5	RAYJ	RAYE	

CARATTERISTICHE / CHARACTERISTICS / EIGENSCHAFTEN / CARACTERISTIQUES / DATOS / ХАРАКТЕРИСТИКИ

	R11	PENDULUM classe 3 ptv > 36	D-COF > 0,60	BCR μ > 0,40
	B			
	≤ 175 mm <sup>2</sup>			

CERTIFICAZIONI / CERTIFICATIONS / ZERTIFIZIERUNGEN / CERTIFICACIONES / СЕРТИФИКАЦИИ



IMBALLI / PACKAGING / VERPACKUNGEN / EMBALLAGES / EMBALAJES / УПАКОВКИ

	scatole / box / karton / boîte / caja / коробк	pallet / pallet / palette / palette / pallet / поддон				
	M <sup>2</sup>	M <sup>2</sup>	KG	KG	KG	mm
80x80	1	0,64	30,50	45	28,80	1373,00 20

XT20

# Rewind XT20



**R4HS** Corda Rettificato 60x60 - 23<sup>5/8</sup>"x23<sup>5/8</sup>" - **R5AV** Corda Canalina 15x60x8 - 5<sup>7/8</sup>"x23<sup>5/8</sup>"x3<sup>1/8</sup>" -  
**R59M** Corda Elemento Elle 15x60x4 - 5<sup>7/8</sup>"x23<sup>5/8</sup>"x1<sup>9/16</sup>"



## Rewind XT20

gres fine porcellanato colorato in massa / colorbody fine porcelain stoneware / durchgefärbtes feinsteinzeug in einem werkmaß / grès cérame fin coloré dans la masse / gres porcelánico fino coloreado en toda la masa / гомогенный мелкозернистый керамогранит

gruppo Bla UNI EN 14411\_G



outdoor



**60x60 cm**  
23<sup>5/8</sup>"x23<sup>5/8</sup>"  
± 20 mm

**CONCRETE EFFECT**  
Rewind > p.246

# Rewind XT20

60x60 - 23<sup>mm</sup> x 23<sup>mm</sup>

## Polvere



**R4EJ** 60x60  
**R4HP** 60x60 Rett

## Peltro



**R4EK** 60x60  
**R4HQ** 60x60 Rett

## Corda



**R4EM** 60x60  
**R4HS** 60x60 Rett

## Argilla



**R4EL** 60x60  
**R4HR** 60x60 Rett

## TECH INFO

VARIAZIONI CROMATICHE / COLOUR VARIATIONS / FARBVARIATIONEN / VARIATIONS CHROMATIQUES / VARIACIONES CROMÁTICAS / ВАРИАНТЫ ОТТЕНКА



Apprezzabili differenze nell'aspetto di superficie e grafica all'interno della stessa produzione / Clearly distinguishable differences in texture and pattern within the same production run / Auffällige Unterschiede in Aussehen und Struktur innerhalb der gleichen Produktionscharge / Différences visibles au niveau de l'aspect et de la fantaisie entre les carreaux du même lot de production / Diferencias visibles en el aspecto de la superficie y los motivos dentro de un mismo lote de producción / заметные отличия вида поверхности и графики в одной и той же партии

DESTINAZIONE D'USO / INTENDED USE / ANWENDUNGSBEREICH / CHAMP D'APPLICATION / USO PREVISTO / НАЗНАЧЕНИЕ

### H [Outdoor]

Materiali consigliati per sollecitazioni all'abrasione relativamente forti in ambienti anche non protetti da agenti graffianti / Materials recommended for relatively heavy abrasion levels, also in premises not protected against abrasive substances / Materials recommended for relatively heavy abrasion levels, also in premises not protected against abrasive substances / Empfohlen für starke Abriebbeanspruchungen in Bereichen auch ohne Kratzschutzbehandlung / Matériaux recommandés pour des locaux soumis à des fortes contraintes d'abrasion, même non protégés contre les agents abrasifs / Materiales recomendados para soportar esfuerzos de abrasión relativamente intensos incluso en espacios no protegidos frente a agentes abrasivos / Материалы рекомендованы для относительно сильного абразивного воздействия, в том числе в помещениях, не защищенных от царапающих элементов

PEZZI SPECIALI / TRIMS / SPEZIALTEILE / PIÈCES SPÉCIALES / PIEZAS ESPECIALES / СПЕЦИАЛЬНЫЕ ИЗДЕЛИЯ

Tutti i pezzi speciali sono su richiesta e sono coordinabili ai fondi rettificati. Gli imballi vengono calcolati sulla base del quantitativo ordinato / All special pieces are supplied to order and can be matched with the rectified plain tiles. Packaging is calculated on the basis of the quantity ordered / Alle Formteile sind auf Anfrage erhältlich und mit den rektifizierten Grundfliesen kombinierbar. Die Verpackung wird auf der Grundlage der Bestellmenge berechnet / Toutes les pièces spéciales sont fabriquées sur demande et coordonnables aux fonds rectifiés. Les emballages sont calculés en fonction de la quantité commandée / Todas las piezas especiales se entregan bajo pedido y se pueden coordinar con los fondos rectificadas. Los embalajes se calculan según las cantidades encargadas en los pedidos / Все специальные изделия производятся на заказ и сочетаются с обрезной фоновой плиткой. Упаковки рассчитываются на основе заказанного количества

Gradone / Step tile, Elemento Elle / L-edging tile, Bordo U / U-edging tile, Cordolo L / L-kerb tile, Canalina / Gutter tile

Assemblato / Two-piece l-tile / Randstein zweiteilig / Assemblé / Montado / Собранный

CONSIGLI DI POSA / INSTALLATION ADVICE / HINWEISE ZUR VERLEGUNG / CONSEILS DE POSE / SUGERENCIAS PARA LA COLOCACIÓN / РЕКОМЕНДАЦИИ ПО УКЛАДКЕ

Per le pavimentazioni esterne non protette, Ragno consiglia di creare una pendenza  $\geq 1,5\%$  sulla superficie calpestabile allo scopo di limitare il formarsi di ristagni d'acqua localizzati. Nel caso in cui questi ristagni permangano sulla superficie delle piastrelle nonostante una posa a regola d'arte, è necessario intervenire meccanicamente con l'utilizzo di scope o aspira-liquidi / For unprotected outdoor pavings, Ragno recommends the creation of a gradient of  $\geq 1,5\%$  on the finished surface, to prevent the formation of patches of standing water. In the event that standing water persists on the surface of the tiles in spite of correct installation, it must be removed mechanically with the aid of brooms or wet-and-dry vacuum cleaners / Zur Unterbindung von punktueller Stauwasserbildung bei Belägen in ungeschützten Außenbereichen, empfiehlt die Ragno die Ausbildung eines Gefälles  $\geq 1,5\%$  auf der Trittfäche. Sollte trotz fachgerechter Verlegung Stauwasser auf der Fliesenoberfläche zurückbleiben, ist dessen mechanische Entfernung mit Hilfe eines Besens oder Nasssaugers erforderlich / Pour des sols extérieurs non protégés, Ragno conseille de créer une inclinaison  $\geq 1,5\%$  sur la surface de piétinement en vue de limiter la stagnation localisée de l'eau. Si, malgré une pose dans les règles de l'art, cette stagnation devait persister à la surface des carreaux, une intervention mécanique, au moyen de balais et d'aspirateurs de liquides, est alors nécessaire / En el caso de pavimentaciones exteriores no protegidas, Ragno recomienda crear una pendiente  $\geq 1,5\%$  en la superficie transitable para limitar la formación de depósitos localizados de agua estancada. En caso de que estos depósitos de agua permanezcan en la superficie del azulejo, aun cuando la colocación se haya realizado correctamente, será necesario intervenir mecánicamente empleando un cepillo o un aspirador de líquidos / Для наружных незащищенных полов Ragno рекомендует создавать уклон  $\geq 1,5\%$  на пешеходной поверхности для снижения образования локальных застоев воды. В случае, если застои воды образуются на плитке несмотря на правильную укладку, необходимо прибегать к использованию механических средств, таких как щетки или же аппараты для сбора жидкостей

	GRADONE STEP TILE 30x60	GRADONE STEP TILE 30x60	GRADONE STEP TILE 30x60	GRADONE STEP TILE 30x60	GRADONE BORDO TORO NON SMALTATO UNGLAZED BULLNOSE STEP 30x60	ALZATA RISER TILE 20x60	ALZATA RISER TILE 20x60	ALZATA RISER TILE 20x60
LAVORAZIONE LATI TAGLIO + ASSEMBLAGGIO EDGES PRODUCED BY CUTTING + ASSEMBLY	SOLO SU LATO LUNGO ON LONG SIDE ONLY	LATO LUNGO + SX LONG SIDE + L	LATO LUNGO + DX LONG SIDE + R	LATO LUNGO + DX + SX LONG SIDE + R + L	SOLO SU LATO LUNGO ON LONG SIDE ONLY	NESSUN LATO LAVORATO NO SHAPED EDGES	ENTRAMBI I LATI CORTI BOTH SHORT SIDES	DX/SX RIBALTABILE R/L REVERSIBLE
<b>Polvere</b>	<b>R59N</b>	<b>R59S</b>	<b>R59W</b>	<b>R5A9</b>	<b>R9FW</b>	<b>R5AE</b>	<b>R5AJ</b>	<b>R5AN</b>
<b>Peltro</b>	<b>R59P</b>	<b>R59T</b>	<b>R59X</b>	<b>R5AA</b>	<b>R9FX</b>	<b>R5AF</b>	<b>R5AK</b>	<b>R5AP</b>
<b>Corda</b>	<b>R59R</b>	<b>R59V</b>	<b>R59Z</b>	<b>R5AD</b>	<b>R9FY</b>	<b>R5AH</b>	<b>R5AM</b>	<b>R5AR</b>
<b>Argilla</b>	<b>R59Q</b>	<b>R59U</b>	<b>R59Y</b>	<b>R5AC</b>	<b>R9FZ</b>	<b>R5AG</b>	<b>R5AL</b>	<b>R5AQ</b>
LAVORAZIONE ROMPIGOCCIA NON-DRIP EDGE	SU 2 LATI LUNGHICI ON THE 2 LONG SIDES	SU 3 LATI ON 3 SIDES						
<b>Polvere</b>	<b>R5CK</b>	<b>R5CP</b>	<b>R59J</b>	<b>R5AW</b>	<b>R5CA</b>	<b>R5AS</b>	<b>R5CF</b>	
<b>Peltro</b>	<b>R5CL</b>	<b>R5CQ</b>	<b>R59K</b>	<b>R5AX</b>	<b>R5CC</b>	<b>R5AT</b>	<b>R5CG</b>	
<b>Corda</b>	<b>R5CN</b>	<b>R56R</b>	<b>R59M</b>	<b>R5AZ</b>	<b>R5CE</b>	<b>R5AV</b>	<b>R5CJ</b>	
<b>Argilla</b>	<b>R5CM</b>	<b>R5CR</b>	<b>R59L</b>	<b>R5AY</b>	<b>R5CD</b>	<b>R5AU</b>	<b>R5CH</b>	

CARATTERISTICHE / CHARACTERISTICS / EIGENSCHAFTEN / CARACTERISTIQUES / DATOS / ХАРАКТЕРИСТИКИ

	<b>R11</b>	<b>PENDULUM classe 3</b>	<b>D-COF &gt; 0,60</b>
	<b>B</b>		
	<b>≤ 175 mm<sup>2</sup></b>		

CERTIFICAZIONI / CERTIFICATIONS / ZERTIFIZIERUNGEN / CERTIFICATIONS / CERTIFICACIONES / СЕРТИФИКАЦИИ



IMBALLI / PACKAGING / VERPACKUNGEN / EMBALLAGES / EMBALAJES / УПАКОВКИ

	scatole / box / karton / boîte / caja / короб			pallet / pallet / palette / palette / pallet / поддон			
	□	M <sup>2</sup>	KG	□	M <sup>2</sup>	KG	± mm
60x60		0,72	34,79	32	23,04	1113,34	20
60x60 Rettificato		0,72	33,73	32	23,04	1079,50	20

XT20

# Concept XT20



CONCEPT XT20 | XT20

R45M Grigio Rettificato 60x60 - 23<sup>5/8</sup>"x23<sup>5/8</sup>"



CONCEPT XT20 | XT20

## Concept XT20

gres fine porcellanato colorato in massa - rettificato monocalibro / colorbody fine porcelain stoneware - rectified monocaliber / durchgefärbtes feinsteinzeug - rektifiziert, in einem werkmaß / grès cérame fin coloré dans la masse - rectifié monocalibre / gres porcelánico fino coloreado en toda la masa - rectificado monocalibre / гомогенный мелкозернистый керамогранит - ректифицированный монокалиберный

gruppo Bia UNI EN 14411\_G



outdoor

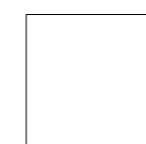

60x60 cm  
23<sup>5/8</sup>"x23<sup>5/8</sup>"  
± 20 mm

CONCRETE EFFECT  
Concept > p.252

# Concept XT20

60x60 - 23<sup>mm</sup> x 23<sup>mm</sup>

Beige



R45P 60x60 Rett

Greige



R45N 60x60 Rett

Grigio



R45M 60x60 Rett

Nero



R45Q 60x60 Rett

## TECH INFO

VARIAZIONI CROMATICHE / COLOUR VARIATIONS / FARBVARIATIONEN / VARIATIONS CHROMATIQUES / VARIACIONES CROMÁTICAS / ВАРИАНТЫ ОТТЕНКА



Apprezzabili differenze nell'aspetto di superficie e grafica all'interno della stessa produzione / Clearly distinguishable differences in texture and pattern within the same production run / Auffällige Unterschiede in Aussehen und Struktur innerhalb der gleichen Produktionscharge / Différences visibles au niveau de l'aspect et de la fantaisie entre les carreaux du même lot de production / Diferencias visibles en el aspecto de la superficie y los motivos dentro de un mismo lote de producción / заметные отличия вида поверхности и графики в одной и той же партии

DESTINAZIONE D'USO / INTENDED USE / ANWENDUNGSBEREICH / CHAMP D'APPLICATION / USO PREVISTO / НАЗНАЧЕНИЕ

### H [Outdoor]

Materiali consigliati per sollecitazioni all'abrasione relativamente forti in ambienti anche non protetti da agenti graffianti / Materials recommended for relatively heavy abrasion levels, also in premises not protected against abrasive substances / Materials recommended for relatively heavy abrasion levels, also in premises not protected against abrasive substances / Empfohlen für starke Abriebbeanspruchungen in Bereichen auch ohne Kratzschutzbehandlung / Matériaux recommandés pour des locaux soumis à des fortes contraintes d'abrasion, même non protégés contre les agents abrasifs / Materiales recomendados para soportar esfuerzos de abrasión relativamente intensos incluso en espacios no protegidos frente a agentes abrasivos / Материалы рекомендованы для относительно сильного абразивного воздействия, в том числе в помещениях, не защищенных от царапающих элементов

PEZZI SPECIALI / TRIMS / SPEZIALTEILE / PIÈCES SPÉCIALES / PIEZAS ESPECIALES / СПЕЦИАЛЬНЫЕ ИЗДЕЛИЯ

Tutti i pezzi speciali sono su richiesta e sono coordinabili ai fondi rettificati. Gli imballi vengono calcolati sulla base del quantitativo ordinato / All special pieces are supplied to order and can be matched with the rectified plain tiles. Packaging is calculated on the basis of the quantity ordered / Alle Formteile sind auf Anfrage erhältlich und mit den rektifizierten Grundfliesen kombinierbar. Die Verpackung wird auf der Grundlage der Bestellmenge berechnet / Toutes les pièces spéciales sont fabriquées sur demande et coordonnables aux fonds rectifiés. Les emballages sont calculés en fonction de la quantité commandée / Todas las piezas especiales se entregan bajo pedido y se pueden coordinar con los fondos rectificadas. Los embalajes se calculan según las cantidades encargadas en los pedidos / Все специальные изделия производятся на заказ и сочетаются с обрезной фоновой плиткой. Упаковки рассчитываются на основе заказанного количества

Gradone / Step tile, Elemento Elle / L-edging tile, Bordo U / U-edging tile, Cordolo L / L-kerb tile, Canalina / Gutter tile

Assemblato / Two-piece l-tile / Randstein zweiteilig / Assemblé / Montado / Собранный

CONSIGLI DI POSA / INSTALLATION ADVICE / HINWEISE ZUR VERLEGUNG / CONSEILS DE POSE / SUGERENCIAS PARA LA COLOCACIÓN / РЕКОМЕНДАЦИИ ПО УКЛАДКЕ

Per le pavimentazioni esterne non protette, Ragno consiglia di creare una pendenza  $\geq 1,5\%$  sulla superficie calpestabile allo scopo di limitare il formarsi di ristagni d'acqua localizzati. Nel caso in cui questi ristagni permangano sulla superficie delle piastrelle nonostante una posa a regola d'arte, è necessario intervenire meccanicamente con l'utilizzo di scope o aspira-liquidi / For unprotected outdoor pavings, Ragno recommends the creation of a gradient of  $\geq 1,5\%$  on the finished surface, to prevent the formation of patches of standing water. In the event that standing water persists on the surface of the tiles in spite of correct installation, it must be removed mechanically with the aid of brooms or wet-and-dry vacuum cleaners / Zur Unterbindung von punktueller Stauwasserbildung bei Belägen in ungeschützten Außenbereichen, empfiehlt die Ragno die Ausbildung eines Gefälles  $\geq 1,5\%$  auf der Trittlfläche. Sollte trotz fachgerechter Verlegung Stauwasser auf der Fliesenoberfläche zurückbleiben, ist dessen mechanische Entfernung mit Hilfe eines Besens oder Nasssaugers erforderlich / Pour des sols extérieurs non protégés, Ragno conseille de créer une inclinaison  $\geq 1,5\%$  sur la surface de piétinement en vue de limiter la stagnation localisée de l'eau. Si, malgré une pose dans les règles de l'art, cette stagnation devait persister à la surface des carreaux, une intervention mécanique, au moyen de balais et d'aspirateurs de liquides, est alors nécessaire / En el caso de pavimentaciones exteriores no protegidas, Ragno recomienda crear una pendiente  $\geq 1,5\%$  en la superficie transitada para limitar la formación de depósitos localizados de agua estancada. En caso de que estos depósitos de agua permanezcan en la superficie del azulejo, aun cuando la colocación se haya realizado correctamente, será necesario intervenir mecánicamente empleando un cepillo o un aspirador de líquidos / Для наружных незащищенных полов Ragno рекомендует создавать уклон  $\geq 1,5\%$  на пешеходной поверхности для снижения образования локальных застоев воды. В случае, если застои воды образуются на плитке несмотря на правильную укладку, необходимо прибегать к использованию механических средств, таких как щетки или же аппараты для сбора жидкостей

	GRADONE STEP TILE 30x60	GRADONE STEP TILE 30x60	GRADONE STEP TILE 30x60	GRADONE STEP TILE 30x60	GRADONE BORDO TORO NON SMALTATO UNGLAZED BULLNOSE STEP 30x60	ALZATA RISER TILE 20x60	ALZATA RISER TILE 20x60	ALZATA RISER TILE 20x60
LAVORAZIONE LATI TAGLIO + ASSEMBLAGGIO EDGES PRODUCED BY CUTTING + ASSEMBLY	SOLO SU LATO LUNGO ON LONG SIDE ONLY	LATO LUNGO + SX LONG SIDE + L	LATO LUNGO + DX LONG SIDE + R	LATO LUNGO + SX LONG SIDE + R + L	SOLO SU LATO LUNGO ON LONG SIDE ONLY	NESSUN LATO LAVORATO NO SHAPED EDGES	ENTRAMBI I LATI CORTI BOTH SHORT SIDES	DX/SX RIBALTABILE R/L REVERSIBILE
Beige	R57W	R580	R584	R589	R96T	R58E	R58J	R58N
Greige	R57X	R581	R585	R58A	R96V	R58F	R58K	R58P
Grigio	R57Y	R582	R587	R58C	R96X	R58G	R58L	R58Q
Nero	R57Z	R583	R588	R58D	R96Z	R58H	R58M	R58R

	COPRI MURETTO COPING TILE 30x60	COPRI MURETTO COPING TILE 30x60	ELEMENTO ELLE L-EDGING TILE 15x60x4	BORDO U U-EDGING TILE 15x60x15	CORDOLO L L-KERB TILE 15x60x20	CANALINA GUTTER TILE 15x60x8	GRIGLIA GRID TILE 15x60
LAVORAZIONE ROMPIGOCCIA NON-DRIP EDGE	SU 2 LATI LUNGH ON THE 2 LONG SIDES	SU 3 LATI ON 3 SIDES					
Beige	R599	R59E	R45T	R58W	R590	R58S	R594
Greige	R59A	R59F	R45S	R58X	R591	R58T	R595
Grigio	R59C	R59G	R45R	R58Y	R592	R58U	R597
Nero	R59D	R59H	R45U	R58Z	R593	R58V	R598

CARATTERISTICHE / CHARACTERISTICS / EIGENSCHAFTEN / CARACTERISTIQUES / DATOS / ХАРАКТЕРИСТИКИ

	R11	PENDULUM classe 3 ptv > 36	D-COF > 0,60	BCR $\mu > 0,40$
	B			
		$\leq 175 \text{ mm}^2$		

CERTIFICAZIONI / CERTIFICATIONS / ZERTIFIZIERUNGEN / CERTIFICACIONES / СЕРТИФИКАЦИИ



IMBALLI / PACKAGING / VERPACKUNGEN / EMBALLAGES / EMBALAJES / УПАКОВКИ

	scatole / box / karton / boîte / caja / короб			pallet / pallet / palette / palette / pallet / поддон			
		M <sup>2</sup>	KG		M <sup>2</sup>	KG	mm
60x60		0,72	32,00		23,04	1032,00	20
15x60	E.ELLE	0,18	5,16	-	-	-	-

# WALL TILES



- 474 Resina
- 482 Cocciopesto
- 490 Tactile
- 498 Terracruda
- 504 Bistrot Wall
- 510 Ritual
- 516 TexCem
- 524 Imperiale Wall
- 532 Tempera
- 540 Off
- 544 Flex
- 550 Frame
- 556 Freestyle
- 560 Rewind Wall
- 566 Trama
- 574 Fantasy
- 578 Brick Glossy
- 584 Touch

WALL TILES

# Resina



R79Z Terracotta Rettificato 40x120 - 15<sup>3/8</sup> x 47<sup>1/4</sup> - R79W Rosa Rettificato 40x120 - 15<sup>3/8</sup> x 47<sup>1/4</sup> - R7RK Listello Ossido 0,5x120 - 3/16 x 47<sup>1/4</sup>



## Resina

rivestimenti in pasta bianca - rettificato / white bodywall tiles - rectified / wandfliesen aus weissen ton scherben - rektifiziert / revetements en pate blanche - rectifié / revestimientos en pasta blanca - rectificado / облицовка из белой глины - ректифицировавший

gruppo BIII UNI EN 14411\_L

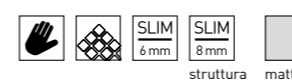

40x120 cm  
15<sup>3/8</sup> x 47<sup>1/4</sup>  
± 6 mm - 8 mm

# Resina

80x120 - 31<sup>1/2</sup>"x47<sup>1/4</sup>" 40x120 - 15<sup>3/4</sup>"x47<sup>1/4</sup>" 40x43 - 15<sup>3/4</sup>"x16<sup>15/16</sup>" 40x40 - 15<sup>3/4</sup>"x15<sup>3/4</sup>" 0,5x120 - 3/16"x47<sup>1/4</sup>"

## Bianco

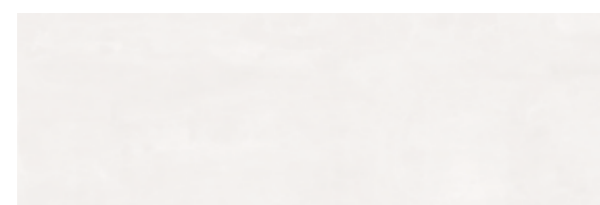

R79U 40x120 Rett

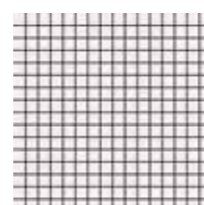

R7LW 40x40 Mosaico

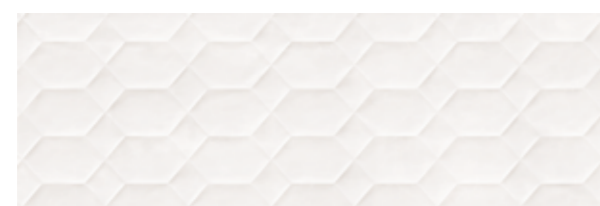

R79M 40x120 Strutturata Bee 3D Rett



R7LN 40x43 Mosaico Forme



R79E 40x120 Strutturata Wall 3D Rett

## Grigio

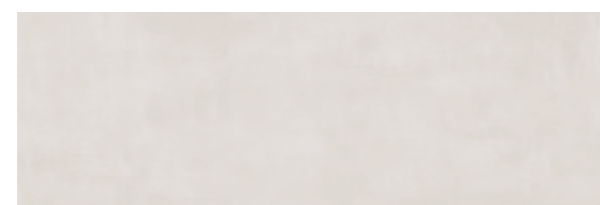

R79V 40x120 Rett

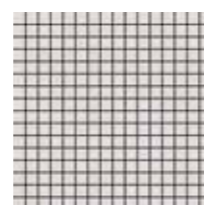

R7LX 40x40 Mosaico



R79N 40x120 Strutturata Bee 3D Rett



R7LQ 40x43 Mosaico Forme



R79F 40x120 Strutturata Wall 3D Rett

## Ardesia



R79X 40x120 Rett

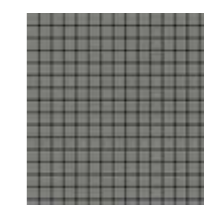

R7LY 40x40 Mosaico



R79Q 40x120 Strutturata Bee 3D Rett



R7LR 40x43 Mosaico Forme



R79H 40x120 Strutturata Wall 3D Rett

## Avorio

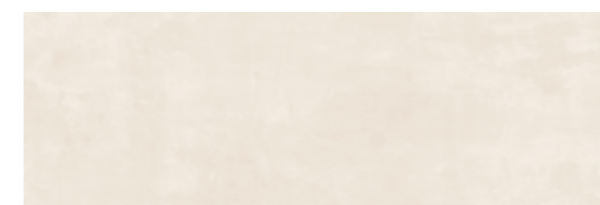

R79Y 40x120 Rett

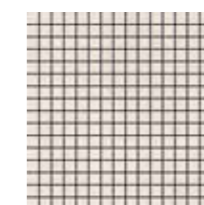

R7LV 40x40 Mosaico



R79R 40x120 Strutturata Bee 3D Rett



R7LM 40x43 Mosaico Forme



R79K 40x120 Strutturata Wall 3D Rett



# Resina

80x120 - 31<sup>1/2</sup>"x47<sup>1/4</sup>" 40x120 - 15<sup>3/4</sup>"x47<sup>1/4</sup>" 40x43 - 15<sup>3/4</sup>"x16<sup>15/16</sup>" 40x40 - 15<sup>3/4</sup>"x15<sup>3/4</sup>" 0,5x120 - 3/16"x47<sup>1/4</sup>"

## Rosa



**R79W** 40x120 Rett

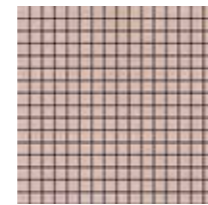

**R7LU** 40x40 Mosaico



**R79P** 40x120 Struttura Bee 3D Rett

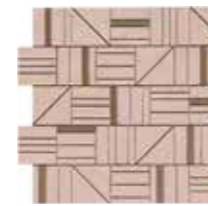

**R7LL** 40x43 Mosaico Forme



**R79G** 40x120 Struttura Wall 3D Rett

## Terracotta



**R79Z** 40x120 Rett



**R7LT** 40x40 Mosaico



**R795** 40x120 Struttura Bee 3D Rett



**R7LK** 40x43 Mosaico Forme



**R79J** 40x120 Struttura Wall 3D Rett

## Decors



**R7AD** 40x120 Decoro Bricks Bianco

Abbinabile ai colori / Matching with colours / Mit den Grundfliesen kombinierbar / Peut s'associer aux carreaux de base de couleurs / Puede combinarse con los fondos / Сочетается с фоновой плиткой



**Bianco Grigio Ardesia**



**R7AA** 40x120 Decoro Bricks Avorio

Abbinabile ai colori / Matching with colours / Mit den Grundfliesen kombinierbar / Peut s'associer aux carreaux de base de couleurs / Puede combinarse con los fondos / Сочетается с фоновой плиткой

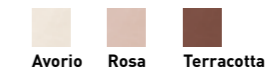

**Avorio Rosa Terracotta**



**R8CC** 40x120 Decoro Venezia Bianco

Abbinabile ai colori / Matching with colours / Mit den Grundfliesen kombinierbar / Peut s'associer aux carreaux de base de couleurs / Puede combinarse con los fondos / Сочетается с фоновой плиткой

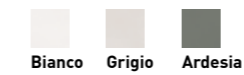

**Bianco Grigio Ardesia**



**R8CA** 40x120 Decoro Venezia Avorio

Abbinabile ai colori / Matching with colours / Mit den Grundfliesen kombinierbar / Peut s'associer aux carreaux de base de couleurs / Puede combinarse con los fondos / Сочетается с фоновой плиткой

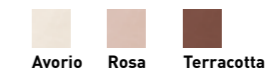

**Avorio Rosa Terracotta**



**R7RQ** 80x120 Decoro Tropicana

Abbinabile ai colori / Matching with colours / Mit den Grundfliesen kombinierbar / Peut s'associer aux carreaux de base de couleurs / Puede combinarse con los fondos / Сочетается с фоновой плиткой



**Bianco Rosa Terracotta Ardesia**

**R7RK** 0,5x120 Listello Ossido

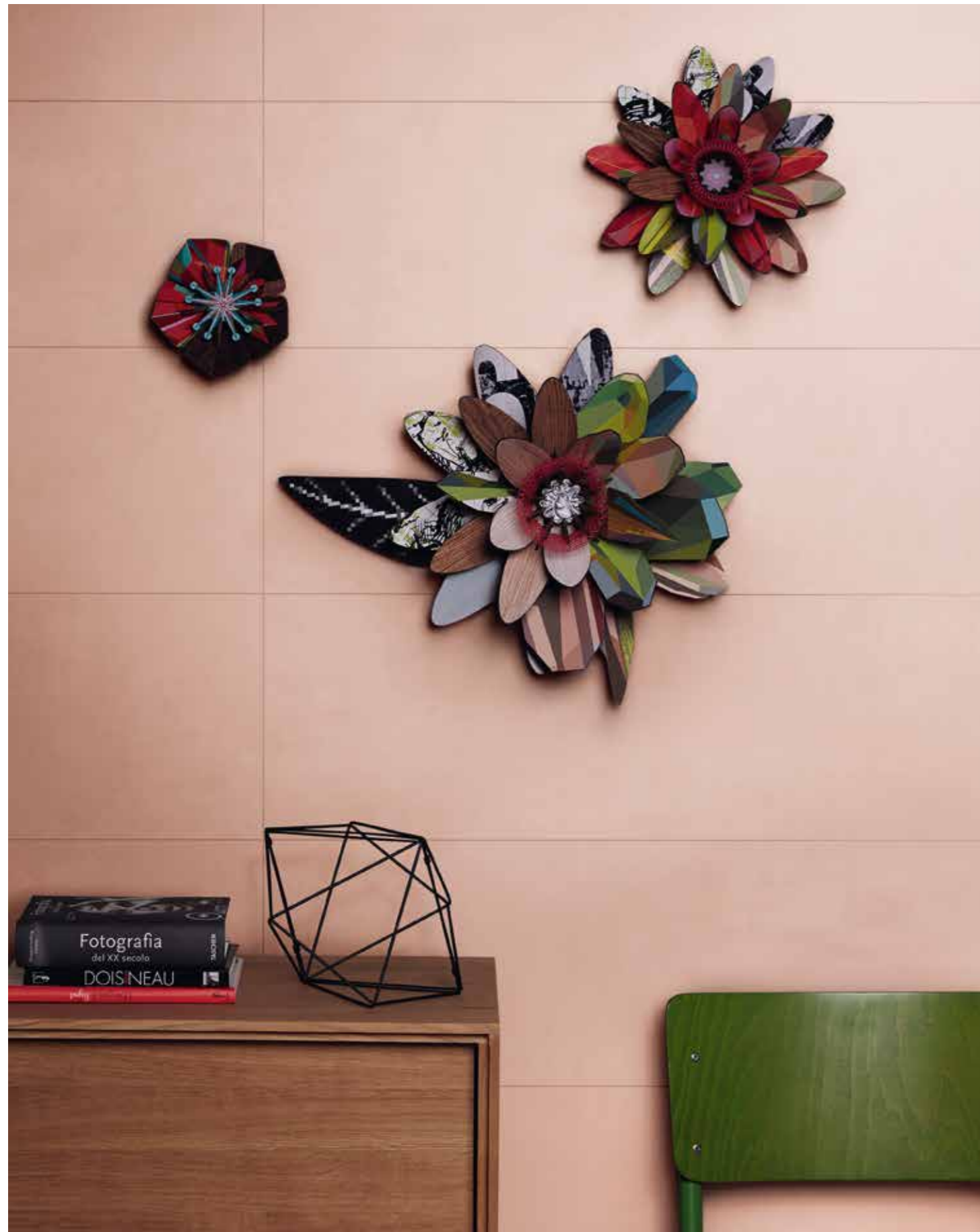

R79W Rosa Rettificato 40x120 - 15<sup>34</sup> x47<sup>34</sup>

**TECH INFO**

DECORI / DECORATIVE PIECES / DEKORE / DÉCORS /  
DECORACIONES / ДЕКОРЫ

**Decoro Venezia**

Decoro con lustri/metalli preziosi utilizzabile a rivestimento; si consiglia la pulizia con detersivi neutri, non abrasivi. È sconsigliata la posa nell'area doccia / Decors with lustres/precious metals used for covering; we recommend cleaning with neutral, non-abrasive detergents. Tiles should not be installed in the shower area / Dekor mit Glanzelementen/Edelmetallen für die Wandverkleidung; es wird die Reinigung mit neutralen, scheuermittelfreien Reinigungsmitteln empfohlen. Die Verlegung in der Duschnische wird nicht empfohlen / Décor avec lustres/métaux précieux à poser sur le mur. Lavage recommandé avec des détergents neutres, non abrasifs. Pose déconseillée dans la douche / Decoración con elementos brillantes/metales preciosos utilizable para revestir superficies; se recomienda limpiarla con detergentes neutros, no abrasivos. Se desaconseja colocarla en el área de la ducha / Декор с блестящим покрытием/ драгоценными металлами, используемый для облицовки; рекомендуется чистка с использованием нейтральных, неабразивных моющих средств. Не рекомендуется укладка в душевой зоне

**Mosaico, Mosaico Forme**

Mosaico assemblato su rete in fibra di vetro / Mosaic mesh - mounted on fibreglass / Auf Glasfasernetz geklebtes Mosaik / Mosaïque montée sur filet en fibre de verre / Mosaico enmallado sobre fibra de vidrio / Мозаика, собранная на сетке из стекловолокна

**Decoro Tropicana**

2 diversi soggetti nel formato 60x120 / 2 different motifs in size 60x120 / 2 verschiedene Motive im Format 60x120 / 2 sujets différents dans le format 60x120 / 2 piezas en el formato de 60 x 120 cm / 2 штуки в формате 60x120 см

**IMBALLI / PACKAGING / VERPACKUNGEN / EMBALAJES / УПАКОВКИ**

		scatole / box / karton / boîte / caja / коробк			pallet / pallet / palette / palette / pallet / поддон			
		□	M²	KG	□	M²	KG	± mm
40x120	Rettificato	6	2,88	30,79	16	46,08	492,73	6
40x120	Struttura Bee 3D	5	2,40	26,59	16	38,40	425,44	8
40x120	Struttura Wall 3D	5	2,40	28,39	16	38,40	454,33	8
40x120	Decoro Bricks	6	2,88	30,00	-	-	-	-
40x120	Decoro Venezia	4	1,92	21,05	-	-	-	-
80x120	Decoro Tropicana	1	0,96	11,00	-	-	-	-
40x43	Mosaico Forme	4	0,69	9,00	40	27,52	360,00	-
40x40	Mosaico	4	0,64	9,00	60	38,40	540,01	6
0,5x120	Listello Ossido	6	0,04	2,00	-	-	-	6

# Cocciopesto



R6TV Mosaico Rettificato Cotto 40x40 - 15<sup>3/4</sup> x 15<sup>3/4</sup>"



## Cocciopesto

rivestimenti in pasta bianca - rettificato / white bodywall tiles - rectified / wandfliesen aus weissen ton scherben - rektifiziert / revetements en pate blanche - rectifié / revestimientos en pasta blanca - rectificado / облицовка из белой глины - ректифицированный

gruppo BIII UNI EN 14411\_L



40x120 cm  
15<sup>3/4</sup> x 47<sup>1/4</sup>"  
± 6 mm - 8 mm

# Cocciopesto

40x120 - 15<sup>3/4</sup> x 47<sup>1/4</sup> 40x40 - 15<sup>3/4</sup> x 15<sup>3/4</sup> 0,5x120 - 3/16 x 47<sup>1/4</sup>

## Bianco

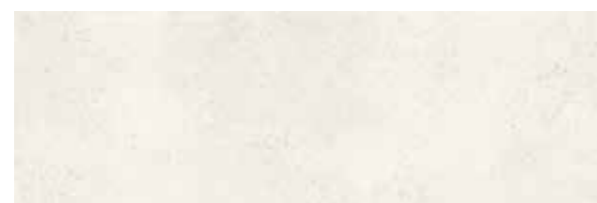

R5T2 40x120 Rett

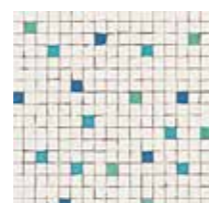

R6TS 40x40 Mosaico



R5TC 40x120 Struttura Arena 3D Rett

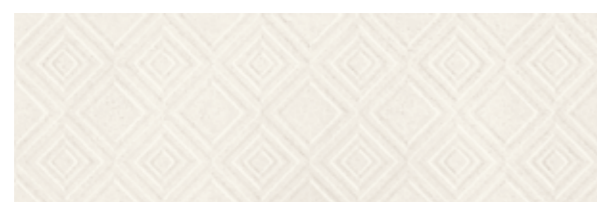

R6ZL 40x120 Struttura Class 3D Rett

## Grigio

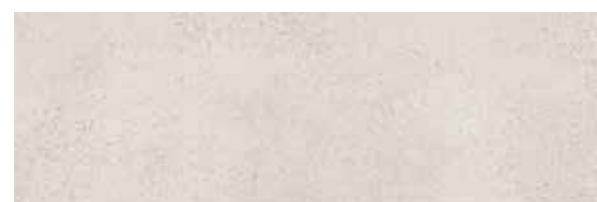

R5T1 40x120 Rett

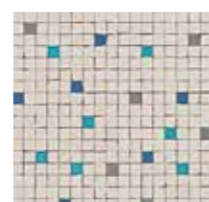

R6TR 40x40 Mosaico



R5TA 40x120 Struttura Arena 3D Rett



R6ZK 40x120 Struttura Class 3D Rett

## Antracite



R5T0 40x120 Rett



R6TQ 40x40 Mosaico



R6ZH 40x120 Struttura Class 3D Rett

## Avorio

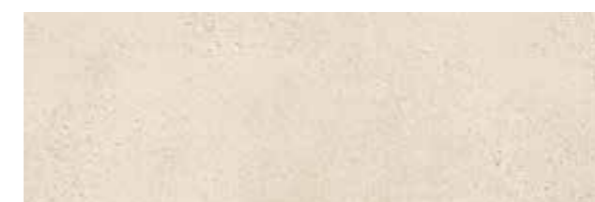

R5T3 40x120 Rett



R6TT 40x40 Mosaico



R5TD 40x120 Struttura Arena 3D Rett

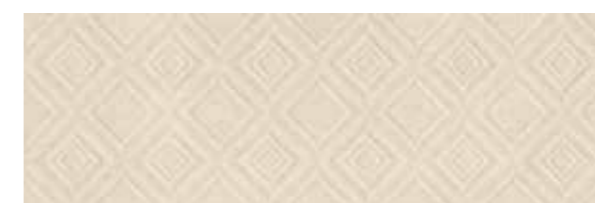

R6ZJ 40x120 Struttura Class 3D Rett

# Cocciopesto

40x120 - 15<sup>3/4</sup>"x47<sup>1/4</sup>" 40x40 - 15<sup>3/4</sup>"x15<sup>3/4</sup>" 0,5x120 - 3/16"x47<sup>1/4</sup>"

## Cotto



**R5T9** 40x120 Rett



**R6TV** 40x40 Mosaico



**R6ZG** 40x120 Struttura Class 3D Rett

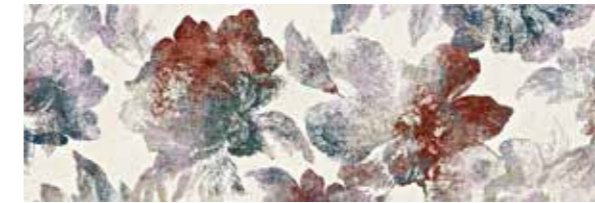

**R6XM** 40x120 Decoro Botanico Bianco

Abbinabile ai colori / Matching with colours / Mit den Grundfliesen kombinierbar / Peut s'associer aux carreaux de base de couleurs / Puede combinarse con los fondos / Сочетается с фоновой плиткой



**Bianco**

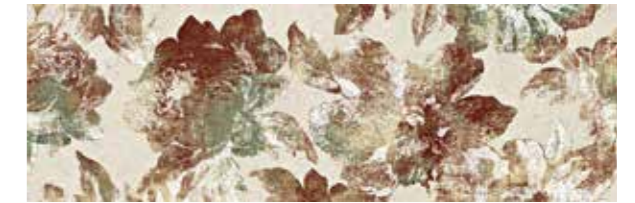

**R6XP** 40x120 Decoro Botanico Avorio

Abbinabile ai colori / Matching with colours / Mit den Grundfliesen kombinierbar / Peut s'associer aux carreaux de base de couleurs / Puede combinarse con los fondos / Сочетается с фоновой плиткой



**Avorio**

## Decors



**R5UX** 40x120 Decoro Caleido Bianco

Abbinabile ai colori / Matching with colours / Mit den Grundfliesen kombinierbar / Peut s'associer aux carreaux de base de couleurs / Puede combinarse con los fondos / Сочетается с фоновой плиткой



**Bianco Grigio Antracite**



**R5UY** 40x120 Decoro Caleido Avorio

Abbinabile ai colori / Matching with colours / Mit den Grundfliesen kombinierbar / Peut s'associer aux carreaux de base de couleurs / Puede combinarse con los fondos / Сочетается с фоновой плиткой



**Avorio Cotto**



**R6TM** 40x120 Decoro Opera Bianco

Abbinabile ai colori / Matching with colours / Mit den Grundfliesen kombinierbar / Peut s'associer aux carreaux de base de couleurs / Puede combinarse con los fondos / Сочетается с фоновой плиткой



**Bianco**



**R6TN** 40x120 Decoro Opera Avorio

Abbinabile ai colori / Matching with colours / Mit den Grundfliesen kombinierbar / Peut s'associer aux carreaux de base de couleurs / Puede combinarse con los fondos / Сочетается с фоновой плиткой



**Avorio**

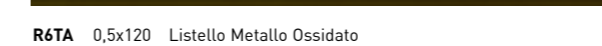

**R6TA** 0,5x120 Listello Metallo Ossidato

# Cocciopesto



R5UX Decoro Caleido Bianco 40x120 - 15<sup>3/4</sup> x 47<sup>1/4</sup> - R5T1 Grigio Rettificato 40x120 - 15<sup>3/4</sup> x 47<sup>1/4</sup>

## TECH INFO

DECORI / DECORATIVE PIECES / DEKORE / DÉCORS /  
DECORACIONES / ДЕКОРЫ

### Decoro Opera, Decoro Botanico

Decoro con lustri/metalli preziosi utilizzabile a rivestimento; si consiglia la pulizia con detergenti neutri, non abrasivi. È sconsigliata la posa nell'area doccia / Decors with lustres/precious metals used for covering; we recommend cleaning with neutral, non-abrasive detergents. Tiles should not be installed in the shower area / Dekor mit Glanzelementen/Edelmetallen für die Wandverkleidung; es wird die Reinigung mit neutralen, scheuermittelfreien Reinigungsmitteln empfohlen. Die Verlegung in der Duschnische wird nicht empfohlen / Décor avec lustres/métaux précieux à poser sur le mur. Lavage recommandé avec des détergents neutres, non abrasifs. Pose déconseillée dans la douche / Decoración con elementos brillantes/metales preciosos utilizable para revestir superficies; se recomienda limpiarla con detergentes neutros, no abrasivos. Se desaconseja colocarla en el área de la ducha / Декор с блестящим покрытием/ драгоценными металлами, используемый для облицовки; рекомендуется чистка с использованием нейтральных, неабразивных моющих средств. Не рекомендуется укладка в душевой зоне

### Mosaico

Mosaico assemblato su rete in fibra di vetro / Mosaic mesh - mounted on fibreglass / Auf Glasfasernetz geklebtes Mosaik / Mosaïque montée sur filet en fibre de verre / Mosaico enmallado sobre fibra de vidrio / Мозаика, собранная на сетке из стекловолокна

## IMBALLI / PACKAGING / VERPACKUNGEN / EMBALLAGES / EMBALAJES / УПАКОВКИ

		scatole / box / karton / boîte / caja / короб			pallet / pallet / palette / palette / pallet / поддон			
		□	M²	KG	□	M²	KG	± mm
40x120		6	2,88	32,90	16	46,08	526,36	6
40x120	Struttura 3D	5	2,40	30,43	16	38,40	486,93	8
40x120	Decoro Caleido	6	2,88	33,03	16	46,08	528,40	6
40x120	Decoro Opera	4	1,92	12,90	-	-	-	-
40x120	Decoro Botanico	4	1,92	12,90	-	-	-	-
40x40	Mosaico	4	0,64	9,00	60	38,40	540,01	6
0,5x120	Listello Metallo	8	0,05	2,20	-	-	-	-

WALL TILES

# Tactile



TACTILE | WALL TILES



TACTILE | WALL TILES

## Tactile

rivestimenti in pasta bianca - rettificato / white bodywall tiles - rectified / wandfliesen aus weissen ton scherben - rektifiziert / revetements en pate blanche - rectifié / revestimientos en pasta blanca - rectificado / облицовка из белой глины - ректифицированный

gruppo BIII UNI EN 14411\_L

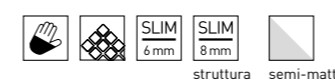

struttura semi-matt



40x120 cm  
15<sup>3/4</sup> x 47<sup>1/4</sup>"  
± 6 mm - 8 mm

**RF6J** Tactile Carbone Rettificato 40x120 - 15<sup>3/4</sup> x 47<sup>1/4</sup>" - **R71Q** Tactile Mosaico Bone Carbone 40x40 - 15<sup>3/4</sup> x 15<sup>3/4</sup>"  
**R56C** Woodmania Caramel 20x120 - 7<sup>7/8</sup> x 47<sup>1/4</sup>" - **R56N** Woodmania Caramel Outdoor 20x120 - 7<sup>7/8</sup> x 47<sup>1/4</sup>"

# Tactile

80x120 - 31<sup>1/2</sup>"x47<sup>3/4</sup>" 40x120 - 15<sup>3/4</sup>"x47<sup>3/4</sup>" 40x40 - 15<sup>3/4</sup>"x15<sup>3/4</sup>"

## Terra



**RKM9** 40x120 Rett



**R71K** 40x40 Mosaico Bone



**R5TV** 40x40 Mosaico Deco



**RKMf** 40x120 Struttura Resina 3D Rett



**RKML** 40x120 Struttura Pizzo 3D Rett

## Ocra



**RKM8** 40x120 Rett



**R71L** 40x40 Mosaico Bone



**RKMf** 40x120 Struttura Resina 3D Rett



**RKMk** 40x120 Struttura Pizzo 3D Rett

## Titanio

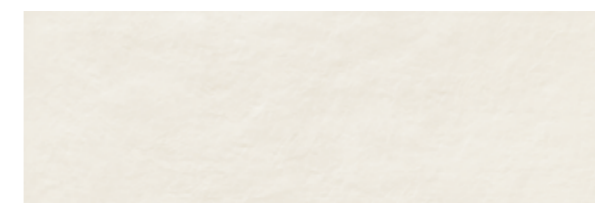

**RKM7** 40x120 Rett



**R71M** 40x40 Mosaico Bone



**R5TW** 40x40 Mosaico Deco



**RKMd** 40x120 Struttura Resina 3D Rett



**RKMj** 40x120 Struttura Pizzo 3D Rett

## Zinco

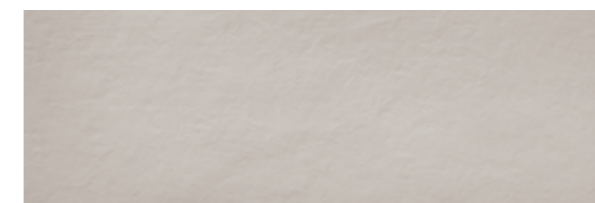

**RKM6** 40x120 Rett



**R71N** 40x40 Mosaico Bone



**RKMc** 40x120 Struttura Resina 3D Rett



**RKMh** 40x120 Struttura Pizzo 3D Rett



# Tactile

80x120 - 31<sup>1/2</sup>"x47<sup>3/4</sup>" 40x120 - 15<sup>3/4</sup>"x47<sup>3/4</sup>" 40x40 - 15<sup>3/4</sup>"x15<sup>3/4</sup>"

## Carbone

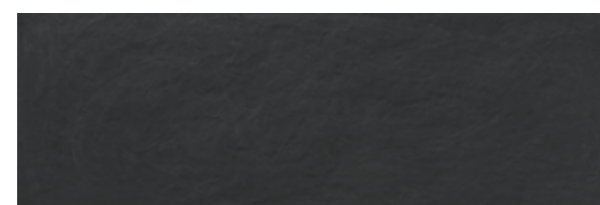

**RFGJ** 40x120 Rett



**R71Q** 40x40 Mosaico Bone



**R5TX** 40x40 Mosaico Deco



**RKMA** 40x120 Struttura Resina 3D Rett



**RKM6** 40x120 Struttura Pizzo 3D Rett

## Decors



**RAV5** 40x120 Decoro Shine Terra



**RAV6** 40x120 Decoro Shine Ocra

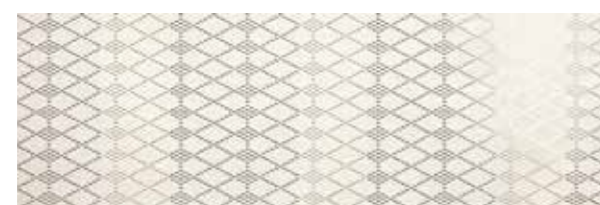

**RAV7** 40x120 Decoro Shine Titanio



**R6LL** 80x120 Decoro Garden Ocra

Abbinabile ai colori / Matching with colours / Mit den Grundfliesen kombinierbar / Peut s'associer aux carreaux de base de couleurs / Puede combinarse con los fondos / Сочетается с фоновой плиткой



**Ocra** **Terra**



**R6LM** 80x120 Decoro Garden Titanio

Abbinabile ai colori / Matching with colours / Mit den Grundfliesen kombinierbar / Peut s'associer aux carreaux de base de couleurs / Puede combinarse con los fondos / Сочетается с фоновой плиткой

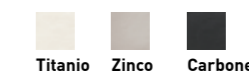

**Titanio** **Zinco** **Carbone**



**R6NA** 40x120 Decoro Memoria Ocra

Abbinabile ai colori / Matching with colours / Mit den Grundfliesen kombinierbar / Peut s'associer aux carreaux de base de couleurs / Puede combinarse con los fondos / Сочетается с фоновой плиткой



**Ocra** **Terra** **Carbone**



**R6N3** 40x120 Decoro Memoria Titanio

Abbinabile ai colori / Matching with colours / Mit den Grundfliesen kombinierbar / Peut s'associer aux carreaux de base de couleurs / Puede combinarse con los fondos / Сочетается с фоновой плиткой

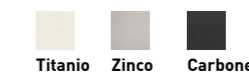

**Titanio** **Zinco** **Carbone**

# Tactile



RKMF Tactile Terra Struttura Resina 3D 40x120 - 15<sup>3/4</sup> x 47<sup>1/4</sup> - R17M Woodchoice Chevron Salt 11x54 - 4<sup>5/16</sup> x 21<sup>1/4</sup>

## TECH INFO

DECORI / DECORATIVE PIECES / DEKORE / DÉCORS /  
DECORACIONES / ДЕКОРЫ

### Decoro Shine, Decoro Garden, Mosaico Bone

Decoro con lustrati/metalli preziosi utilizzabile a rivestimento; si consiglia la pulizia con detergenti neutri, non abrasivi. È sconsigliata la posa nell'area doccia / Decors with lustres/precious metals used for covering; we recommend cleaning with neutral, non-abrasive detergents. Tiles should not be installed in the shower area / Dekor mit Glanzelementen/Edelmetallen für die Wandverkleidung; es wird die Reinigung mit neutralen, scheuermittelfreien Reinigungsmitteln empfohlen. Die Verlegung in der Duschnische wird nicht empfohlen / Décor avec lustres/métaux précieux à poser sur le mur. Lavage recommandé avec des détergents neutres, non abrasifs. Pose déconseillée dans la douche / Decoración con elementos brillantes/metales preciosos utilizable para revestir superficies; se recomienda limpiarla con detergentes neutros, no abrasivos. Se desaconseja colocarla en el área de la ducha / Декор с блестящим покрытием/ драгоценными металлами, используемый для облицовки; рекомендуется чистка с использованием нейтральных, неабразивных моющих средств. Не рекомендуется укладка в душевой зоне

### Mosaico Deco

Mosaico assemblato su rete in fibra di vetro / Mosaic mesh - mounted on fibreglass / Auf Glasfasernetz geklebtes Mosaik / Mosaïque montée sur filet en fibre de verre / Mosaico enmallado sobre fibra de vidrio / Мозаика, собранная на сетке из стекловолокна

## IMBALLI / PACKAGING / VERPACKUNGEN / EMBALLAGES / EMBALAJES / УПАКОВКИ

		scatole / box / karton / boîte / caja / короб			pallet / pallet / palette / palette / pallet / поддон			
		□	M²	KG	□	M²	KG	± mm
40x120		6	2,88	32,90	16	46,08	526,36	6
40x120	Struttura 3D	5	2,40	30,43	16	38,40	486,93	8
40x120	Decoro Memoria	6	2,88	33,03	16	46,08	528,40	6
40x120	Decoro Shine	4	1,92	8,50	-	-	-	-
80x120	Decoro Garden	1	0,96	6,50	-	-	-	-
40x40	Mosaico Deco	4	0,64	8,50	60	38,40	510,00	6
40x40	Mosaico Bone	4	0,64	9,00	60	38,40	540,01	6

WALL TILES

# Terracruda



R6EF Calce Struttura Verso 3D Rettificato 40x120 - 15<sup>3/4</sup>"x47<sup>1/4</sup>" - R060 Mosaico Degradé Luce / Calce 33,2x128,8 - 13<sup>1/16</sup>"x 50<sup>11/16</sup>"



## Terracruda

rivestimenti in pasta bianca - rettificato / white bodywall tiles - rectified / wandfliesen aus weissen ton scherben - rektifiziert / revetements en pate blanche - rectifié / revestimientos en pasta blanca - rectificado / облицовка из белой глины - ректифицируемый

gruppo BIII UNI EN 14411\_L

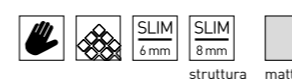

struttura matt



40x120 cm  
15<sup>3/4</sup>"x47<sup>1/4</sup>"  
± 6 mm - 8 mm

# Terracruda

40x120 - 15<sup>3/4</sup>"x47<sup>1/4</sup>" 40x40 - 15<sup>3/4</sup>"x15<sup>3/4</sup>" 33,2x128,8 - 12<sup>11/16</sup>"x50<sup>11/16</sup>" 33,2x33,2 - 12<sup>11/16</sup>"x12<sup>11/16</sup>"

## Luce

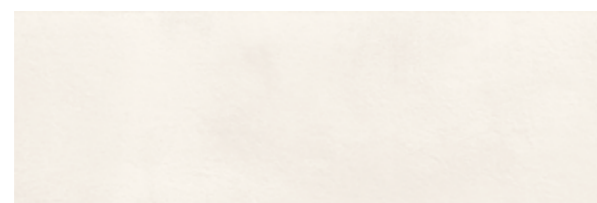

R5MW 40x120 Rett

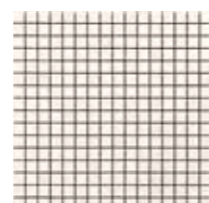

R05K 40x40 Mosaico



R70F 40x120 Struttura Arte 3D Rett

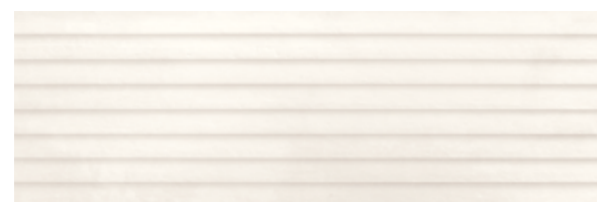

R68M 40x120 Struttura Verso 3D Rett

## Sabbia



R65N 40x120 Rett

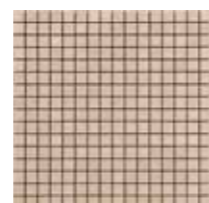

R05L 40x40 Mosaico



R62Q 40x120 Struttura Arte 3D Rett



R693 40x120 Struttura Verso 3D Rett

## Calce



R6MR 40x120 Rett

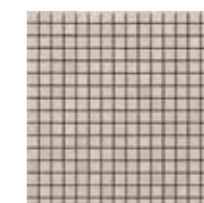

R05J 40x40 Mosaico



R657 40x120 Struttura Arte 3D Rett

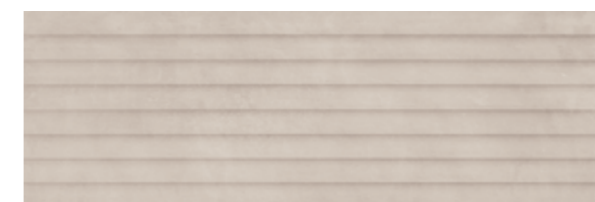

R6EF 40x120 Struttura Verso 3D Rett

## Piombo

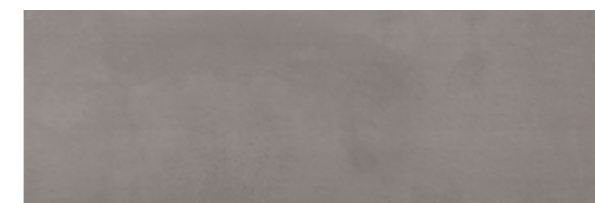

R74J 40x120 Rett

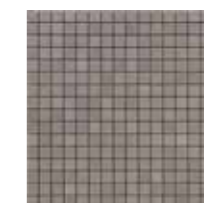

R05H 40x40 Mosaico



R6UZ 40x120 Struttura Arte 3D Rett



R6MK 40x120 Struttura Verso 3D Rett

# Terracruda

40x120 - 15<sup>3/4</sup>x47<sup>1/4</sup> 40x40 - 15<sup>3/4</sup>x15<sup>3/4</sup> 33,2x128,8 - 12<sup>11/16</sup>x50<sup>11/16</sup> 33,2x33,2 - 12<sup>11/16</sup>x12<sup>11/16</sup>

## Decors



**R06A** 33,2x128,8 Mosaico Degradé Luce / Sabbia

Abbinabile ai colori / Matching with colours / Mit den Grundfliesen kombinierbar / Peut s'associer aux carreaux de base de couleurs / Puede combinarse con los fondos / Сочетается с фоновой плиткой



**Luce Sabbia**

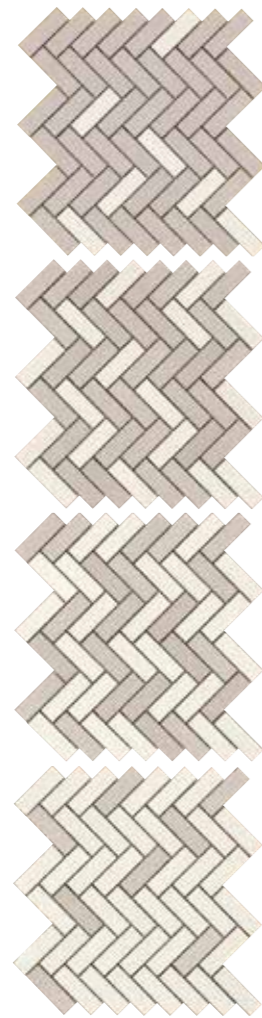

**R060** 33,2x128,8 Mosaico Degradé Luce / Calce

Abbinabile ai colori / Matching with colours / Mit den Grundfliesen kombinierbar / Peut s'associer aux carreaux de base de couleurs / Puede combinarse con los fondos / Сочетается с фоновой плиткой



**Luce Calce**



**R05Y** 33,2x33,2 Mosaico Luce

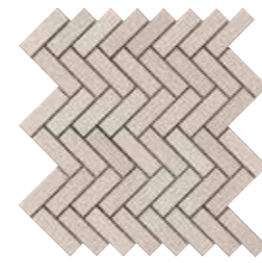

**R05X** 33,2x33,2 Mosaico Calce

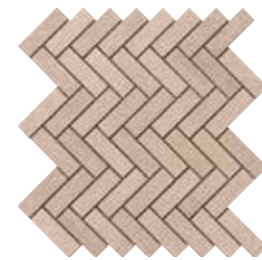

**R05Z** 33,2x33,2 Mosaico Sabbia



**R02N** 40x120 Decoro Carpet Luce

Abbinabile ai colori / Matching with colours / Mit den Grundfliesen kombinierbar / Peut s'associer aux carreaux de base de couleurs / Puede combinarse con los fondos / Сочетается с фоновой плиткой



**Luce Calce Piombo**



**R02M** 40x120 Decoro Carpet Sabbia

Abbinabile ai colori / Matching with colours / Mit den Grundfliesen kombinierbar / Peut s'associer aux carreaux de base de couleurs / Puede combinarse con los fondos / Сочетается с фоновой плиткой



**Luce Sabbia**

## TECH INFO

DECORI / DECORATIVE PIECES / DEKORE / DÉCORS / DECORACIONES / ДЕКОРЫ

### Mosaico

Mosaico assemblato su rete in fibra di vetro / Mosaic mesh - mounted on fibreglass / Auf Glasfasernetz geklebtes Mosaik / Mosaïque montée sur filet en fibre de verre / Mosaico enmallado sobre fibra de vidrio / Мозаика, собранная на сетке из стекловолокна

CONSIGLI DI POSA / INSTALLATION ADVICE / HINWEISE ZUR VERLEGUNG / CONSEILS DE POSE / SUGERENCIAS PARA LA COLOCACIÓN / РЕКОМЕНДАЦИИ ПО УКЛАДКЕ

Posa A / Laying pattern A / Verlegung A / Pose A / Colocación A / Укладка A

Posa B / Laying pattern B / Verlegung B / Pose B / Colocación B / Укладка B

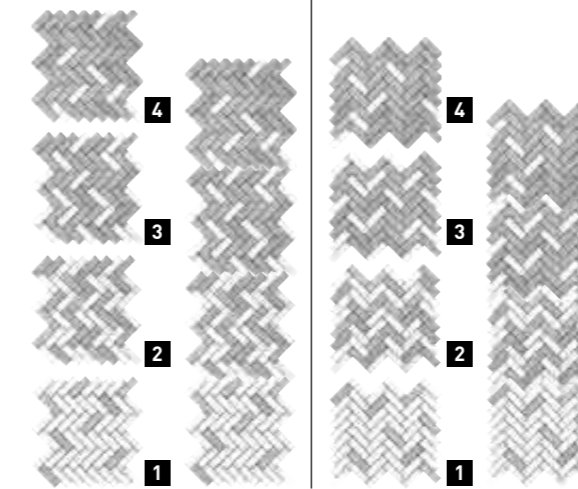

Per una corretta composizione del disegno seguire la numerazione progressiva. Oltre alla posa suggerita (Posa A), la composizione Degradé può essere realizzata ruotando i singoli elementi di 90 gradi (Posa B) / For the correct composition of the pattern, follow the numbered sequence. In addition to the suggested laying pattern (Laying pattern A), the Degradé composition can be created with the individual elements turned by 90 degrees (Laying pattern B) / Pour la bonne composition du dessin, suivre la numérotation séquentielle. Au-delà de la pose suggérée (Pose A), la composition Degradé peut être réalisée en faisant pivoter les éléments de 90 degrés (Pose B) / Für die richtige Zusammensetzung des Musters ist die laufende Nummerierung zu beachten. Neben der empfohlenen Verlegung (Verlegung A) kann Degradé auch unter 90-Grad-Drehung der einzelnen Elemente verlegt werden (Verlegung B) / Para configurar correctamente el dibujo, seguir la numeración progresiva. Además de la colocación sugerida (Colocación A), la composición Degradé se puede realizar rotando los varios elementos noventa grados (Colocación B) / Для правильного составления рисунка придерживайтесь возрастающей нумерации. Помимо рекомендуемой укладки (укладка A), композицию Degradé можно выполнить, поворачивая ее отдельные элементы на 90 градусов (укладка B)

## IMBALLI / PACKAGING / VERPACKUNGEN / EMBALLAGES / EMBALAJES / УПАКОВКИ

	scatole / box / karton / boîte / caja / короб			pallet / pallet / palette / palette / pallet / поддон				
	□	M²	KG	□	M²	KG	± mm	
40x120	6	2,88	32,90	16	46,08	526,36	6	
40x120	Struttura Arte 3D	5	2,40	30,43	16	38,40	486,93	8
40x120	Struttura Verso 3D	5	2,40	31,55	16	38,40	504,76	8
40x120	Decoro	6	2,88	33,03	16	46,08	528,40	6
40x40	Mosaico	4	0,64	5,54	36	23,04	199,40	6
33,2x33,2	Mosaico Lisca	4	0,44	2,08	108	47,62	224,08	6
33,2x128,8	Mosaico Degradé	1	0,43	1,94	-	-	-	6

WALL TILES

# Bistrot Wall



R4UH Pietrasanta Struttura Natura 3D Rettificato 40x120 - 15<sup>3/8</sup>"x47<sup>1/4</sup>" - R4UE Pietrasanta Rettificato 40x120 - 15<sup>3/8</sup>"x47<sup>1/4</sup>"



## Bistrot Wall

rivestimenti in pasta bianca - rettificato / white bodywall tiles - rectified / wandfliesen aus weissen ton scherben - rektifiziert / revêtements en pate blanche - rectifié / revestimientos en pasta blanca - rectificado / облицовка из белой глины - ректифицируемый

gruppo BIII UNI EN 14411\_L

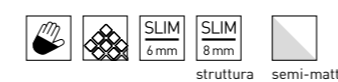

40x120 cm  
15<sup>3/8</sup>"x47<sup>1/4</sup>"  
± 6 mm - 8 mm

MARBLE EFFECT  
Bistrot > p.116

# Bistrot Wall

40x120 - 15<sup>3/4</sup>"x47<sup>1/4</sup>" 40x40 - 15<sup>3/4</sup>"x15<sup>3/4</sup>"

## Pietrasanta



R4UE 40x120 Rett

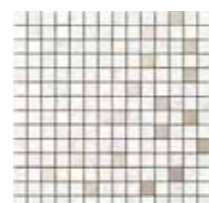

R4ZT 40x40 Mosaico



R4UH 40x120 Struttura Natura 3D Rett



R4UL 40x120 Struttura Dune 3D Rett

## Calacatta Michelangelo



R4UF 40x120 Rett

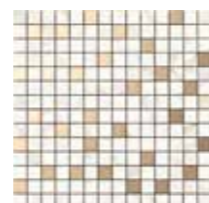

R4ZU 40x40 Mosaico



R4UJ 40x120 Struttura Natura 3D Rett



R4UM 40x120 Struttura Dune 3D Rett

## Marfil



R4UG 40x120 Rett



R4ZV 40x40 Mosaico



R4UK 40x120 Struttura Natura 3D Rett



R4UN 40x120 Struttura Dune 3D Rett

## Decors



R503 40x120 Decoro Pietrasanta



R504 40x120 Decoro Calacatta Michelangelo



R505 40x120 Decoro Marfil

# Bistrot Wall



R4UN Marfil Struttura Dune 3D Rettificato 40x120 - 15<sup>3/4</sup> x 47<sup>1/4</sup>

## TECH INFO

DECORI / DECORATIVE PIECES / DEKORE / DÉCORS /  
DECORACIONES / ДЕКОРЫ

### Decoro, Mosaico

Decoro con lustri/metalli preziosi utilizzabile a rivestimento; si consiglia la pulizia con detergenti neutri, non abrasivi. È sconsigliata la posa nell'area doccia / Decors with lustres/precious metals used for covering; we recommend cleaning with neutral, non-abrasive detergents. Tiles should not be installed in the shower area / Dekor mit Glanzelementen/Edelmetallen für die Wandverkleidung; es wird die Reinigung mit neutralen, scheuermittelfreien Reinigungsmitteln empfohlen. Die Verlegung in der Duschnische wird nicht empfohlen / Décor avec lustres/métaux précieux à poser sur le mur. Lavage recommandé avec des détergents neutres, non abrasifs. Pose déconseillée dans la douche / Decoración con elementos brillantes/metales preciosos utilizable para revestir superficies; se recomienda limpiarla con detergentes neutros, no abrasivos. Se desaconseja colocarla en el área de la ducha / Декор с блестящим покрытием/ драгоценными металлами, используемый для облицовки; рекомендуется чистка с использованием нейтральных, неабразивных моющих средств. Не рекомендуется укладка в душевой зоне

### Mosaico

Mosaico assemblato su rete in fibra di vetro / Mosaic mesh - mounted on fibreglass / Auf Glasfasernetz geklebtes Mosaik / Mosaïque montée sur filet en fibre de verre / Mosaico enmallado sobre fibra de vidrio / Мозаика, собранная на сетке из стекловолокна

CONSIGLI DI POSA / INSTALLATION ADVICE / HINWEISE ZUR  
VERLEGUNG / CONSEILS DE POSE / SUGERENCIAS PARA  
LA COLOCACIÓN / РЕКОМЕНДАЦИИ ПО УКЛАДКЕ

### Decoro

Si consiglia di mantenere il senso di posa indicato / Compliance with the specified laying direction is strongly recommended / Es wird empfohlen, die angegebene Verlegerichtung zu beachten / Il est recommandé de conserver le sens de pose indiqué / Se aconseja mantener el sentido de colocación indicado / Рекомендуется сохранить указанное направление укладки

## IMBALLI / PACKAGING / VERPACKUNGEN / EMBALLAGES / EMBALAJES / УПАКОВКИ

		scatole / box / karton / boîte / caja / коробк			pallet / pallet / palette / palette / pallet / поддон			
		□	M²	KG	□	M²	KG	± mm
40x120		6	2,88	32,90	16	46,08	526,36	6
40x120	Struttura Natura 3D	5	2,40	31,41	16	38,40	502,60	8
40x120	Struttura Dune 3D	5	2,40	31,41	16	38,40	502,60	8
40x120	Decoro	4	1,92	19,70	-	-	-	-
40x40	Mosaico	4	0,64	8,16	60	38,40	489,80	6



WALL TILES

# Ritual



RITUAL | WALL TILES



RITUAL | WALL TILES

## Ritual

rivestimenti in pasta bianca - rettificato / white bodywall tiles - rectified / wandfliesen aus weissen ton scherben - rektifiziert / revetements en pate blanche - rectifié / revestimientos en pasta blanca - rectificado / облицовка из белой глины - ректифицируемый

gruppo BIII UNI EN 14411\_L

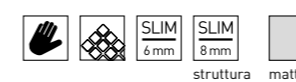

struttura matt

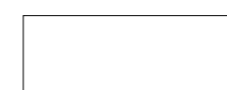

32,5x97,7 cm

12<sup>13/16</sup> x 38<sup>7/16</sup>

± 6 mm - 8 mm

**R6NF** Ritual Greige Rettificato 32,5x97,7 - 12<sup>13/16</sup> x 38<sup>7/16</sup> - **R18E** Ritual Mosaico Greige 32,5x32,5 - 12<sup>13/16</sup> x 12<sup>13/16</sup> - **R84W** Realstone\_Rain Greige Rettificato 75x150 - 29<sup>1/2</sup> x 59<sup>1/8</sup>

# Ritual

130x97,7 - 51<sup>5/16</sup>"x38<sup>7/16</sup>" 32,5x97,7 - 12<sup>13/16</sup>"x38<sup>7/16</sup>" 32,5x32,5 - 12<sup>13/16</sup>"x12<sup>13/16</sup>"

## Bianco

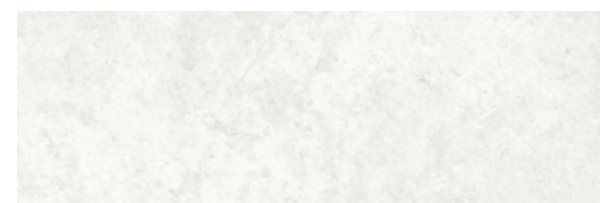

**R6ND** 32,5x97,7 Rett



**R18C** 32,5x32,5 Mosaico



**R6NH** 32,5x97,7 Struttura Microcut 3D Rett

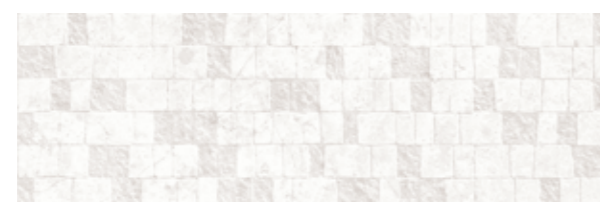

**R6NM** 32,5x97,7 Struttura Domino 3D Rett

## Grigio

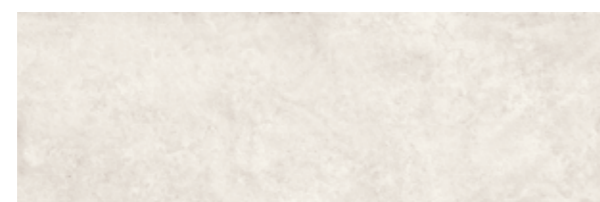

**R6NC** 32,5x97,7 Rett



**R18A** 32,5x32,5 Mosaico

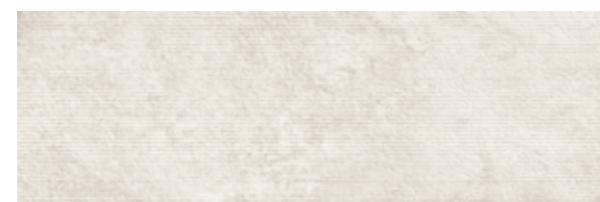

**R6NG** 32,5x97,7 Struttura Microcut 3D Rett

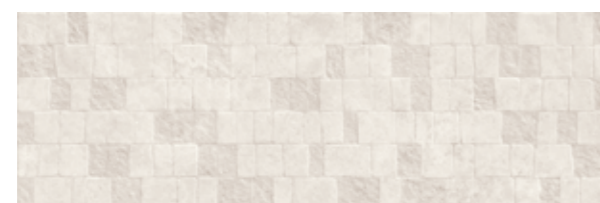

**R6NL** 32,5x97,7 Struttura Domino 3D Rett

## Avorio

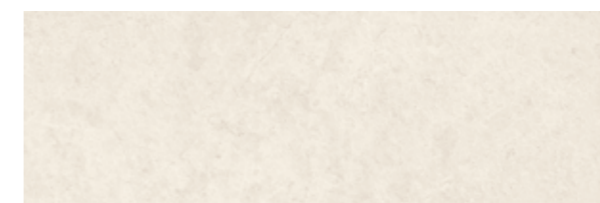

**R6NE** 32,5x97,7 Rett



**R18D** 32,5x32,5 Mosaico

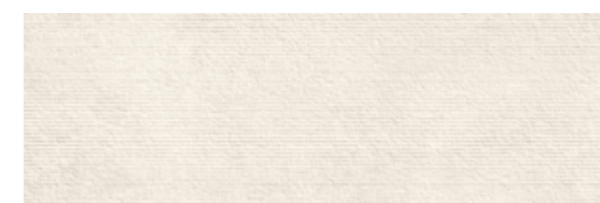

**R6NJ** 32,5x97,7 Struttura Microcut 3D Rett

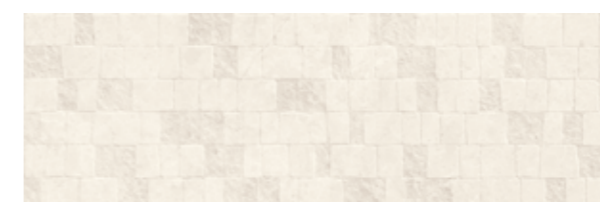

**R6NN** 32,5x97,7 Struttura Domino 3D Rett

## Greige

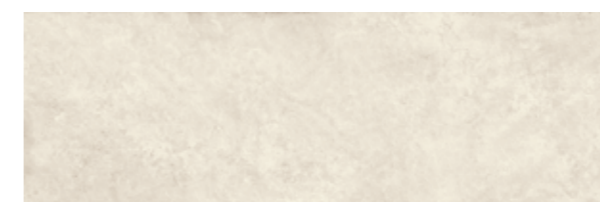

**R6NF** 32,5x97,7 Rett



**R18E** 32,5x32,5 Mosaico



**R6NK** 32,5x97,7 Struttura Microcut 3D Rett

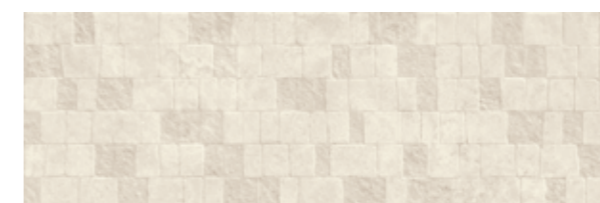

**R6NP** 32,5x97,7 Struttura Domino 3D Rett

## Decors

130x97,7 - 51<sup>3/16</sup> x 38<sup>7/16</sup> 32,5x97,7 - 12<sup>13/16</sup> x 38<sup>7/16</sup> 32,5x32,5 - 12<sup>13/16</sup> x 12<sup>13/16</sup>



**R6NR** 32,5x97,7 Decoro Cross Bianco

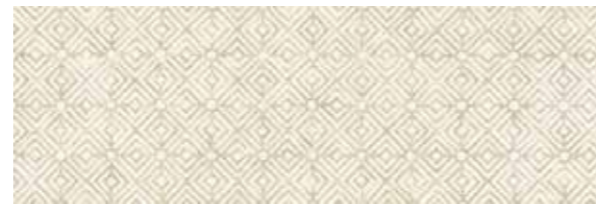

**R6NS** 32,5x97,7 Decoro Cross Avorio



**R724** 32,5x97,7 Decoro Jaquard Bianco



**R725** 32,5x97,7 Decoro Jaquard Avorio



**R50K** 32,5x97,7 Decoro Vanity Bianco

Abbinabile ai colori / Matching with colours / Mit den Grundfliesen kombinierbar / Peut s'associer aux carreaux de base de couleurs / Puede combinarse con los fondos / Сочетается с фоновой плиткой



**Bianco** **Grigio**



**R50L** 32,5x97,7 Decoro Vanity Avorio

Abbinabile ai colori / Matching with colours / Mit den Grundfliesen kombinierbar / Peut s'associer aux carreaux de base de couleurs / Puede combinarse con los fondos / Сочетается с фоновой плиткой



**Avorio** **Greige**



**R50H** 130x97,7 Decoro Bouquet Bianco



**R50J** 130x97,7 Decoro Bouquet Avorio

## TECH INFO

DECORI / DECORATIVE PIECES / DEKORE / DÉCORS / DECORACIONES / ДЕКОРЫ

### Decoro Bouquet, Decoro Jaquard, Decoro Vanity

Decoro con lustri/metalli preziosi utilizzabile a rivestimento; si consiglia la pulizia con detersivi neutri, non abrasivi. È sconsigliata la posa nell'area doccia / Decors with lustres/precious metals used for covering; we recommend cleaning with neutral, non-abrasive detergents. Tiles should not be installed in the shower area / Dekor mit Glanzelementen/Edelmetallen für die Wandverkleidung; es wird die Reinigung mit neutralen, scheuermittelfreien Reinigungsmitteln empfohlen. Die Verlegung in der Duschnische wird nicht empfohlen / Décor avec lustres/métaux précieux à poser sur le mur. Lavage recommandé avec des détergents neutres, non abrasifs. Pose déconseillée dans la douche / Decoración con elementos brillantes/metales preciosos utilizable para revestir superficies; se recomienda limpiarla con detergentes neutros, no abrasivos. Se desaconseja colocarla en el área de la ducha / Декор с блестящим покрытием/ драгоценными металлами, используемый для облицовки; рекомендуется чистка с использованием нейтральных, неабразивных моющих средств. Не рекомендуется укладка в душевой зоне

### Mosaico

Mosaico assemblato su rete in fibra di vetro / Mosaic mesh - mounted on fibreglass / Auf Glasfasernetz geklebtes Mosaik / Mosaïque montée sur filet en fibre de verre / Mosaico enmallado sobre fibra de vidrio / Мозаика, собранная на сетке из стекловолокна

## IMBALLI / PACKAGING / VERPACKUNGEN / EMBALLAGES / EMBALAJES / УПАКОВКИ

		scatole / box / karton / boîte / caja / короб			pallet / pallet / palette / palette / pallet / поддон			
		□	M²	KG	□	M²	KG	± mm
32,5x97,7		6	1,91	21,00	16	30,48	336,29	6
32,5x97,7	Struttura Microcut 3D	5	1,59	19,72	16	25,40	315,00	8
32,5x97,7	Struttura Domino 3D	5	1,59	19,72	16	25,40	315,00	8
32,5x97,7	Decoro Cross	6	1,91	21,00	16	30,48	336,29	6
32,5x97,7	Decoro Jaquard	4	1,27	17,70	-	-	-	-
32,5x97,7	Decoro Vanity	4	1,27	18,00	-	-	-	-
130x97,7	Decoro Bouquet	1	1,27	18,00	-	-	-	-
32,5x32,5	Mosaico	4	0,42	11,86	-	-	-	-

WALL TILES

# TexCem



## TexCem

rivestimenti in pasta bianca - rettificato / white bodywall tiles - rectified / wandfliesen aus weissen ton scherben - rektifiziert / revetements en pate blanche - rectifié / revestimientos en pasta blanca - rectificado / облицовка из белой глины - ректифицируемый

gruppo BIII UNI EN 14411\_L

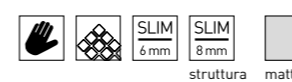

struttura matt

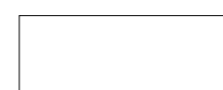

32,5x97,7 cm

12<sup>13/16</sup> x 38<sup>7/16</sup>

± 6 mm - 8 mm

R5NV TexCem Grigio Struttura Tria 3D Rettificato 32,5x97,7 - 12<sup>13/16</sup> x 38<sup>7/16</sup> - R5YS Realstone\_Slate Musk Rettificato 75x150 - 29<sup>1/2</sup> x 59<sup>1/16</sup>

# TexCem

32,5x97,7 - 12<sup>1316</sup>°x38<sup>016</sup>° 32,5x32,5 - 12<sup>1316</sup>°x12<sup>1316</sup>° 130x97,7 - 51<sup>316</sup>°x38<sup>016</sup>°

## Bianco



R5NL 32,5x97,7 Rett

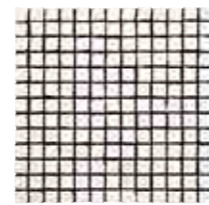

R6TH 32,5x32,5 Mosaico



R5NR 32,5x97,7 Struttura Groove 3D Rett



R5NW 32,5x97,7 Struttura Tria 3D Rett

## Grigio



R5NK 32,5x97,7 Rett

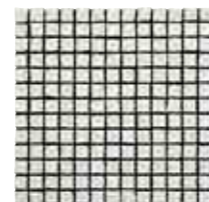

R6TG 32,5x32,5 Mosaico

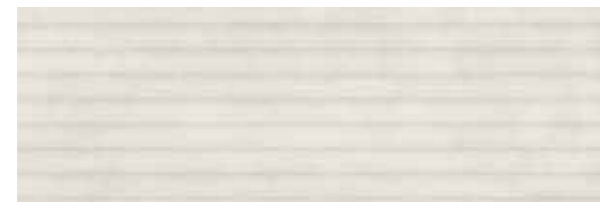

R5NQ 32,5x97,7 Struttura Groove 3D Rett



R5NV 32,5x97,7 Struttura Tria 3D Rett

## Ottanio



R5NJ 32,5x97,7 Rett



R6TF 32,5x32,5 Mosaico



R5NP 32,5x97,7 Struttura Groove 3D Rett

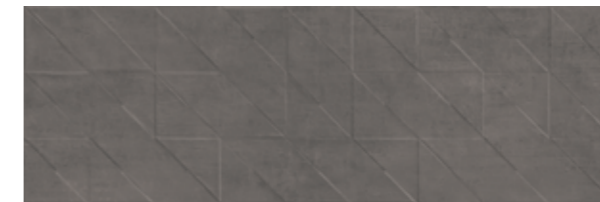

R5NU 32,5x97,7 Struttura Tria 3D Rett

## Avorio



R5NG 32,5x97,7 Rett



R6TD 32,5x32,5 Mosaico



R5NM 32,5x97,7 Struttura Groove 3D Rett



R5NS 32,5x97,7 Struttura Tria 3D Rett

Cotto



R5NH 32,5x97,7 Rett

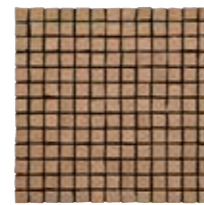

R6TE 32,5x32,5 Mosaico



R5NN 32,5x97,7 Struttura Groove 3D Rett

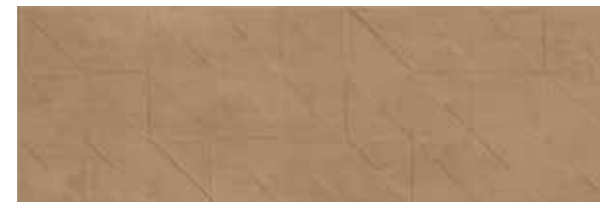

R5NT 32,5x97,7 Struttura Tria 3D Rett

Decors



R5NY 32,5x97,7 Decoro Patch Bianco

Abbinabile ai colori / Matching with colours / Mit den Grundfliesen kombinierbar / Peut s'associer aux carreaux de base de couleurs / Puede combinarse con los fondos / Сочетается с фоновой плиткой



Bianco Grigio Ottanio



R5NX 32,5x97,7 Decoro Patch Avorio

Abbinabile ai colori / Matching with colours / Mit den Grundfliesen kombinierbar / Peut s'associer aux carreaux de base de couleurs / Puede combinarse con los fondos / Сочетается с фоновой плиткой

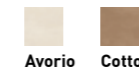

Avorio Cotto

32,5x97,7 - 12<sup>1316</sup> x38<sup>116</sup> 32,5x32,5 - 12<sup>1316</sup> x12<sup>1316</sup> 130x97,7 - 51<sup>316</sup> x38<sup>116</sup>



R5PA 32,5x97,7 Decoro Esagonale Bianco

Abbinabile ai colori / Matching with colours / Mit den Grundfliesen kombinierbar / Peut s'associer aux carreaux de base de couleurs / Puede combinarse con los fondos / Сочетается с фоновой плиткой

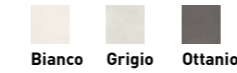

Bianco Grigio Ottanio



R5NZ 32,5x97,7 Decoro Esagonale Avorio

Abbinabile ai colori / Matching with colours / Mit den Grundfliesen kombinierbar / Peut s'associer aux carreaux de base de couleurs / Puede combinarse con los fondos / Сочетается с фоновой плиткой



Avorio Cotto



R6QU 130x97,7 Decoro Magnolia Bianco

Abbinabile ai colori / Matching with colours / Mit den Grundfliesen kombinierbar / Peut s'associer aux carreaux de base de couleurs / Puede combinarse con los fondos / Сочетается с фоновой плиткой

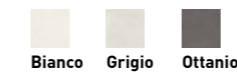

Bianco Grigio Ottanio



R6QT 130x97,7 Decoro Magnolia Avorio

Abbinabile ai colori / Matching with colours / Mit den Grundfliesen kombinierbar / Peut s'associer aux carreaux de base de couleurs / Puede combinarse con los fondos / Сочетается с фоновой плиткой

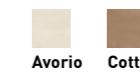

Avorio Cotto

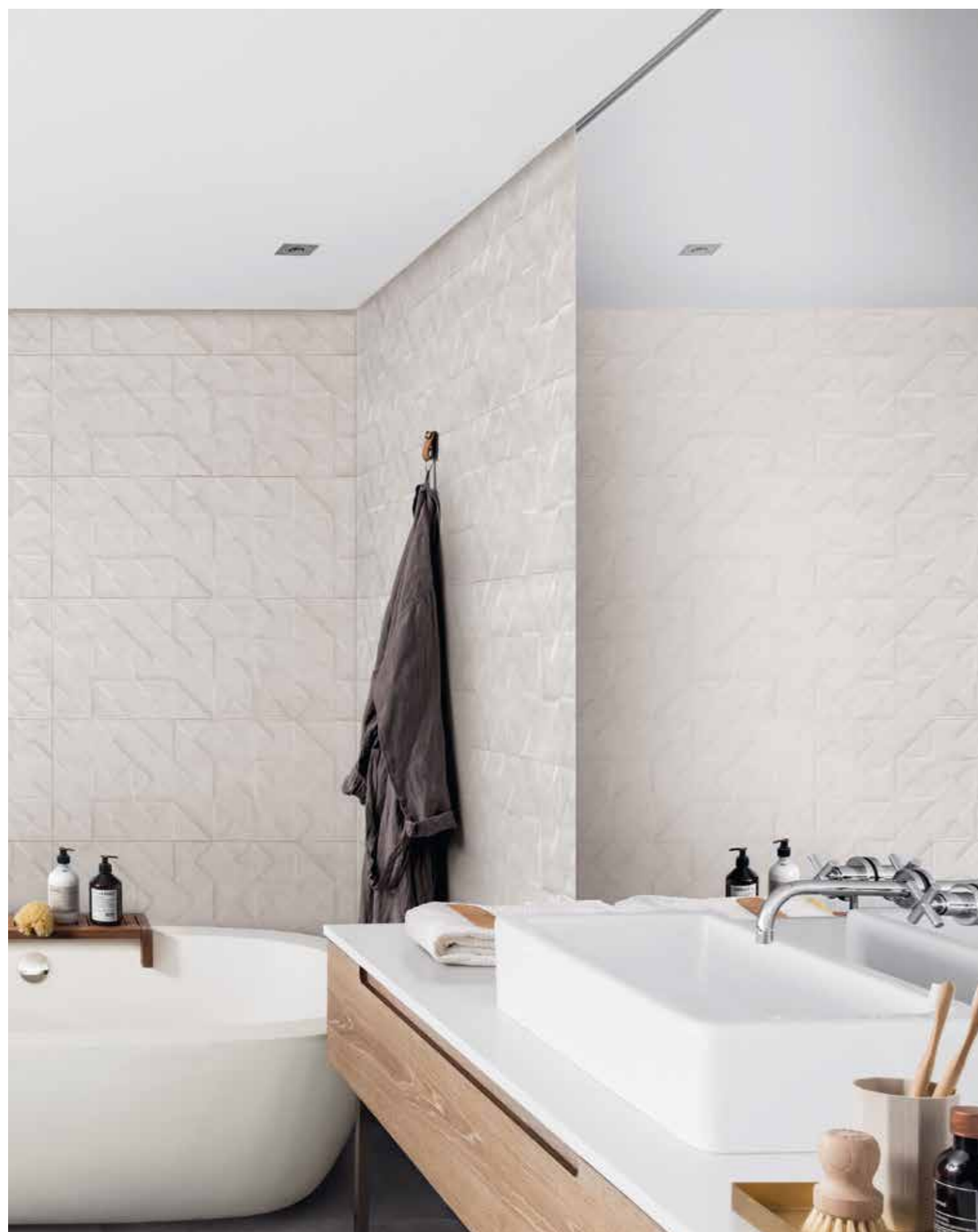

R5NW TexCem Bianco Struttura Tria 3D Rettificato 32,5x97,7 - 12<sup>13/16</sup>x38<sup>7/16</sup> - R5ZC Realstone\_Slate Iron Rettificato 75x75 - 29<sup>1/2</sup>x29<sup>1/2</sup>"

**TECH INFO**

DECORI / DECORATIVE PIECES / DEKORE / DÉCORS /  
DECORACIONES / ДЕКОРЫ

**Mosaico**

Mosaico assemblato su rete in fibra di vetro / Mosaic mesh - mounted  
on fibreglass / Auf Glasfasernetz geklebtes Mosaik / Mosaïque montée  
sur filet en fibre de verre / Mosaico enmallado sobre fibra de vidrio /  
Мозаика, собранная на сетке из стекловолокна

IMBALLI / PACKAGING / VERPACKUNGEN / EMBALLAGES / EMBALAJES / УПАКОВКИ

		scatole / box / karton / boîte / caja / коробк			pallet / pallet / palette / palette / pallet / поддон			
		□	M²	KG	□	M²	KG	± mm
32,5x97,7		6	1,91	21,00	16	30,48	336,29	6
32,5x97,7	Struttura 3D	5	1,59	21,00	16	25,40	336,01	8
32,5x97,7	Decoro Patch, Esagone	6	1,91	21,00	16	30,48	336,29	6
130x97,7	Decoro Magnolia	1	1,27	4,25	-	-	-	-
32,5x32,5	Mosaico	4	0,42	12,50	48	20,28	596,00	6

# Imperiale Wall



**R74F** Calacatta Rettificato 30x90 - 11<sup>13</sup>/<sub>16</sub>" x 35<sup>7</sup>/<sub>16</sub>" - **R758** Calacatta Struttura Gemma 3D Rettificato 30x90 - 11<sup>13</sup>/<sub>16</sub>" x 35<sup>7</sup>/<sub>16</sub>"  
**R72Z** Calacatta Glossy Rettificato 58x58 - 22<sup>13</sup>/<sub>16</sub>" x 22<sup>13</sup>/<sub>16</sub>"



## Imperiale Wall

rivestimenti in pasta bianca - rettificato / white bodywall tiles - rectified / wandfliesen aus weissen ton scherben - rektifiziert / revetements en pate blanche - rectifié / revestimientos en pasta blanca - rectificado / облицовка из белой глины - ректифицировабный

gruppo BIII UNI EN 14411\_L



glossy

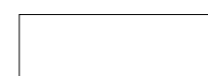

**30x90 cm**  
 11<sup>13</sup>/<sub>16</sub>" x 35<sup>7</sup>/<sub>16</sub>"  
 ± 10 mm

**MARBLE EFFECT**  
 Imperiale > p.126



# Imperiale Wall

30x90 - 11<sup>13/16</sup>"x35<sup>7/16</sup>" 30x30 - 11<sup>13/16</sup>"x11<sup>13/16</sup>" 1x90 - 3/8"x35<sup>7/16</sup>"

## Bianco



R74D 30x90 Rett



R75K 30x30 Mosaico



R755 30x90 Struttura Gemma 3D Rett



R74M 30x90 Struttura Shangai 3D Rett

## Statuarietto



R74E 30x90 Rett

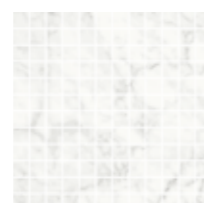

R75L 30x30 Mosaico



R757 30x90 Struttura Gemma 3D Rett

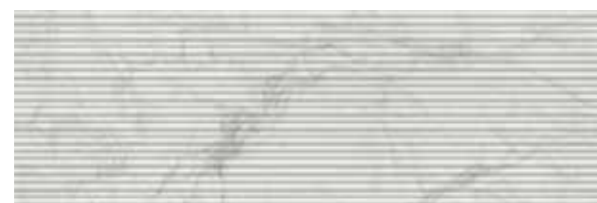

R74N 30x90 Struttura Shangai 3D Rett

## Calacatta



R74F 30x90 Rett



R75M 30x30 Mosaico



R758 30x90 Struttura Gemma 3D Rett



R74P 30x90 Struttura Shangai 3D Rett

## Avorio



R74G 30x90 Rett



R75N 30x30 Mosaico



R759 30x90 Struttura Gemma 3D Rett



R74Q 30x90 Struttura Shangai 3D Rett

# Imperiale Wall

30x90 - 11<sup>13/16</sup>"x35<sup>7/16</sup>" 30x30 - 11<sup>13/16</sup>"x11<sup>13/16</sup>" 1x90 - 3/8"x35<sup>7/16</sup>"

## Travertino



R74H 30x90 Rett

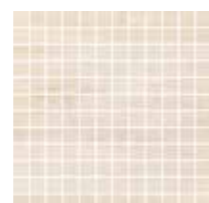

R75P 30x30 Mosaico



R75A 30x90 Struttura Gemma 3D Rett



R74R 30x90 Struttura Shangai 3D Rett

## Crema



R74K 30x90 Rett

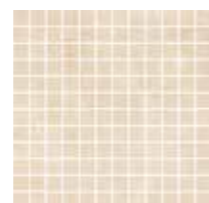

R75Q 30x30 Mosaico



R75C 30x90 Struttura Gemma 3D Rett



R74S 30x90 Struttura Shangai 3D Rett

## Decors



R75T 30x90 Decoro Merletto Bianco 3D Rett



R75U 30x90 Decoro Merletto Statuarietto 3D Rett



R75V 30x90 Decoro Merletto Calacatta 3D Rett

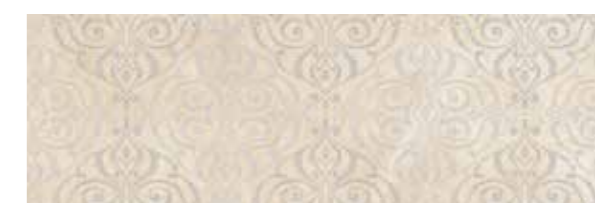

R75W 30x90 Decoro Merletto Crema 3D Rett





R75E 30x90 Decoro Tangram Bianco





R75G 30x90 Decoro Tangram Travertino

Abbinabile ai colori / Matching with colours / Mit den Grundfliesen kombinierbar / Peut s'associer aux carreaux de base de couleurs / Puede combinarse con los fondos / Сочетается с фоновой плиткой

 **Bianco**  **Statuarietto**

Abbinabile ai colori / Matching with colours / Mit den Grundfliesen kombinierbar / Peut s'associer aux carreaux de base de couleurs / Puede combinarse con los fondos / Сочетается с фоновой плиткой

 **Travertino**  **Crema**

R75Y 1x90 Imperiale Listello Titanio

# Imperiale Wall



**R74D** Imperiale Bianco Rettificato 30x90 - 11<sup>13</sup>/<sub>16</sub> x 35<sup>7</sup>/<sub>16</sub>" - **R75E** Imperiale Decoro Tangram Bianco 30x90 - 11<sup>13</sup>/<sub>16</sub> x 35<sup>7</sup>/<sub>16</sub>"  
**R5RW** Woodclassic Beige Rettificato 13x100 / 10x100 - 5<sup>1</sup>/<sub>8</sub>" x 39<sup>3</sup>/<sub>8</sub>" / 3<sup>15</sup>/<sub>16</sub>" x 39<sup>3</sup>/<sub>8</sub>"

## TECH INFO

DECORI / DECORATIVE PIECES / DEKORE / DÉCORS /  
 DECORACIONES / ДЕКОРЫ

### Mosaico

Mosaico assemblato su rete in fibra di vetro / Mosaic mesh - mounted  
 on fibreglass / Auf Glasfasernetz geklebtes Mosaik / Mosaïque montée  
 sur filet en fibre de verre / Mosaico enmallado sobre fibra de vidrio /  
 Мозаика, собранная на сетке из стекловолокна

IMPERIALE WALL | WALL TILES

IMPERIALE WALL | WALL TILES

## IMBALLI / PACKAGING / VERPACKUNGEN / EMBALLAGES / EMBALAJES / УПАКОВКИ

	scatole / box / karton / boîte / caja / короб			pallet / pallet / palette / palette / pallet / поддон				
	□	M²	KG	□	M²	KG	+ mm	
30x90	5	1,35	23,21	40	54,00	928,63	10	
30x90	Struttura Gemma 3D	5	1,35	19,16	40	54,00	766,50	10
30x90	Struttura Shangai 3D	5	1,35	21,17	40	54,00	847,06	10
30x30	Mosaico	4	0,36	6,40	60	21,60	384,00	10
30x90	Decoro Tangram	5	1,35	22,72	40	54,00	909,09	10
30x90	Decoro Merletto	2	0,54	9,52	-	-	-	-
1x90	Listello Titanio	8	0,07	1,50	-	-	-	-

WALL TILES

# Tempera



R6ZN Fango Rettificato 30x90 - 11<sup>13/16</sup> x 35<sup>7/16</sup>"



## Tempera

rivestimenti in pasta bianca - rettificato / white bodywall tiles - rectified / wandfliesen aus weissen ton scherben - rektifiziert / revetements en pate blanche - rectifié / revestimientos en pasta blanca - rectificado / облицовка из белой глины - ректифицируемый

gruppo BIII UNI EN 14411\_L

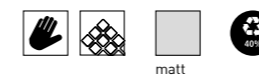

matte

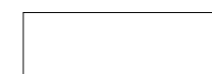

30x90 cm  
11<sup>13/16</sup> x 35<sup>7/16</sup>"  
± 10 mm

# Tempera

30x90 - 11<sup>13/16</sup>"x35<sup>7/16</sup>" 30x30 - 11<sup>13/16</sup>"x11<sup>13/16</sup>"

## Bianco

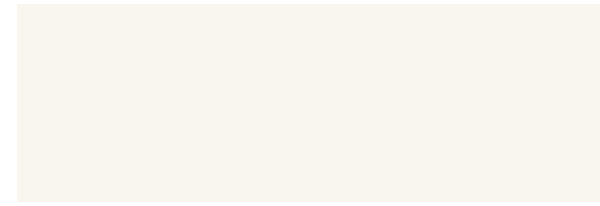

**R6ZR** 30x90 Rett

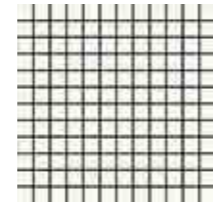

**R70T** 30x30 Mosaico



**R707** 30x90 Struttura Shanghai 3D Rett

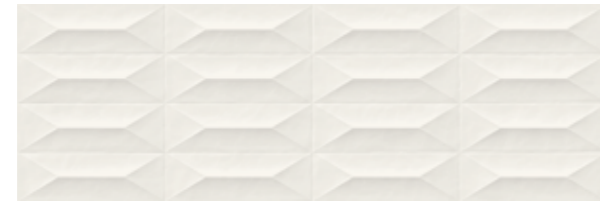

**R6ZZ** 30x90 Struttura Trape 3D Rett

## Crema

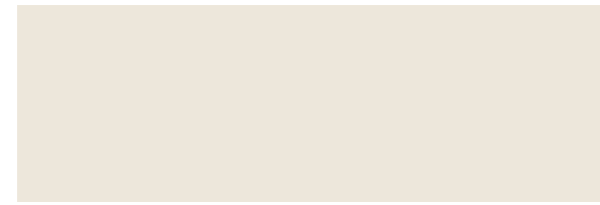

**R6ZP** 30x90 Rett

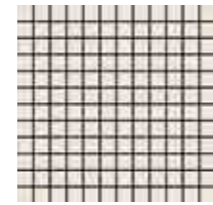

**R70R** 30x30 Mosaico



**R705** 30x90 Struttura Shanghai 3D Rett

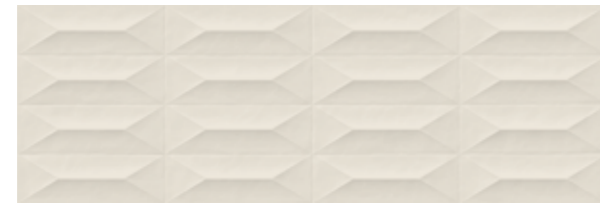

**R6ZY** 30x90 Struttura Trape 3D Rett

## Fango



**R6ZN** 30x90 Rett

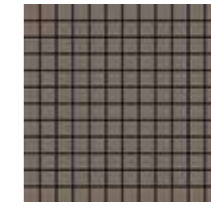

**R70M** 30x30 Mosaico



**R6ZW** 30x90 Struttura Trape 3D Rett

## Antracite



**R6ZS** 30x90 Rett

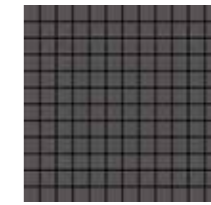

**R70U** 30x30 Mosaico



**R700** 30x90 Struttura Trape 3D Rett

# Tempera

30x90 - 11<sup>13/16</sup>"x35<sup>7/16</sup>" 30x30 - 11<sup>13/16</sup>"x11<sup>13/16</sup>"

## Verde



**R6ZT** 30x90 Rett

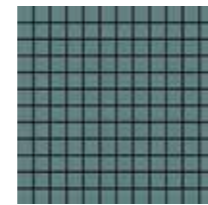

**R70V** 30x30 Mosaico



**R708** 30x90 Struttura Shangai 3D Rett



**R701** 30x90 Struttura Trape 3D Rett

## Blu



**R6ZU** 30x90 Rett

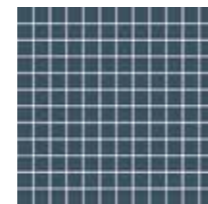

**R70X** 30x30 Mosaico



**R709** 30x90 Struttura Shangai 3D Rett



**R703** 30x90 Struttura Trape 3D Rett

## Decors



**R70C** 30x90 Decoro Time Crema

Abbinabile ai colori / Matching with colours / Mit den Grundfliesen kombinierbar / Peut s'associer aux carreaux de base de couleurs / Puede combinarse con los fondos / Сочетается с фоновой плиткой



**R70G** 30x90 Decoro Time Blu

Abbinabile ai colori / Matching with colours / Mit den Grundfliesen kombinierbar / Peut s'associer aux carreaux de base de couleurs / Puede combinarse con los fondos / Сочетается с фоновой плиткой



**R76N** 30x90 Decoro Tape Crema

Abbinabile ai colori / Matching with colours / Mit den Grundfliesen kombinierbar / Peut s'associer aux carreaux de base de couleurs / Puede combinarse con los fondos / Сочетается с фоновой плиткой



**R76P** 30x90 Decoro Tape Bianco

Abbinabile ai colori / Matching with colours / Mit den Grundfliesen kombinierbar / Peut s'associer aux carreaux de base de couleurs / Puede combinarse con los fondos / Сочетается с фоновой плиткой



# Tempera



**R6ZR** Tempera Bianco Rettificato 30x90 - 11<sup>13/16</sup> x 35<sup>7/16</sup>" - **R703** Tempera Blu Struttura Trape 3D Rettificato 30x90 - 11<sup>13/16</sup> x 35<sup>7/16</sup>"  
**R5RZ** Woodclassic Grigio 13x100 / 10x100 - 5<sup>1/8</sup> x 39<sup>3/8</sup>" / 3<sup>15/16</sup> x 39<sup>3/8</sup>"

## TECH INFO

DECORI / DECORATIVE PIECES / DEKORE / DÉCORS /  
 DECORACIONES / ДЕКОРЫ

### Mosaico

Mosaico assemblato su rete in fibra di vetro / Mosaic mesh - mounted  
 on fibreglass / Auf Glasfasernetz geklebtes Mosaik / Mosaïque montée  
 sur filet en fibre de verre / Mosaico enmallado sobre fibra de vidrio /  
 Мозаика, собранная на сетке из стекловолокна

## IMBALLI / PACKAGING / VERPACKUNGEN / EMBALLAGES / EMBALAJES / УПАКОВКИ

		scatole / box / karton / boîte / caja / короб			pallet / pallet / palette / palette / pallet / поддон			
		□	M <sup>2</sup>	KG	□	M <sup>2</sup>	KG	± mm
30x90		5	1,35	22,20	40	54,00	888,01	10
30x90	Struttura Trape 3D	5	1,35	18,77	40	54,00	751,04	10
30x90	Struttura Shangai 3D	5	1,35	21,08	40	54,00	843,22	10
30x30	Mosaico	4	0,36	6,40	60	21,60	384,00	10
30x90	Decoro Time	5	1,35	21,74	40	54,00	869,57	10
30x90	Decoro Tape	2	0,54	10,00	-	-	-	-

WALL TILES

# Off



**R760** Off Bianco Satinato 30x90 - 11<sup>13/16</sup> x 35<sup>7/16</sup>"  
**R6ZN** Tempera Fango Rettificato 30x90 - 11<sup>13/16</sup> x 35<sup>7/16</sup>" - **R4NV** Replace Tortora Rettificato 60x60 - 23<sup>5/8</sup> x 23<sup>5/8</sup>"



## Off

rivestimenti in pasta bianca / white bodywall tiles / wandfliesen aus weissen ton scherben / revetements en pate blanche / revestimientos en pasta blanca / облицовка из белой глины  
gruppo **BIII UNI EN 14411\_L**

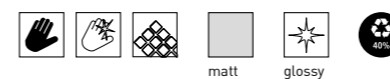

matt glossy

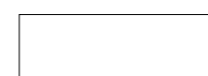

**30x90 cm**  
11<sup>13/16</sup> x 35<sup>7/16</sup>"  
± 10 mm



# Off

30x90 - 11<sup>13/16</sup>" x 35<sup>7/16</sup>"

## Bianco

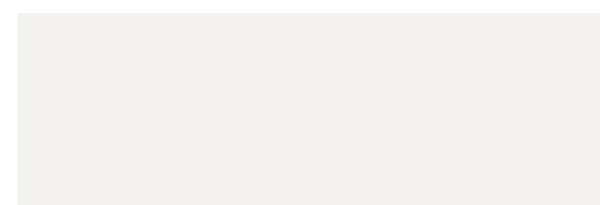

**R760** 30x90 Satinato



**R76E** 30x90 Struttura Gemma 3D



**R76J** 30x90 Struttura Shangai 3D

## Crema

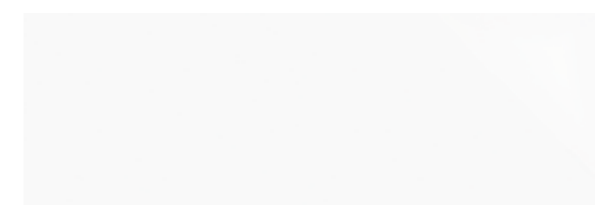

**R76C** 30x90 Lux



**R76L** 30x90 Struttura Gemma 3D Lux

OFF | WALL TILES

OFF | WALL TILES

### IMBALLI / PACKAGING / VERPACKUNGEN / EMBALLAGES / EMBALAJES / УПАКОВКИ

	scatole / box / karton / boîte / caja / коробк			pallet / pallet / palette / palette / pallet / поддон			
	□	M²	KG	□	M²	KG	± mm
30x90	5	1,35	21,11	40	54,00	844,41	10

WALL TILES

# Flex



R03E Flex Cielo Struttura Fibra 3D 25x76 - 9<sup>13/16</sup>"x29<sup>15/16</sup>" - R06R Woodglam Noce 10x70 - 3<sup>15/16</sup>"x27<sup>9/16</sup>"



## Flex

rivestimenti in pasta bianca / white bodywall tiles / wandfliesen aus weissen ton scherben / revetements en pate blanche / revestimientos en pasta blanca / облицовка из белой глины  
gruppo BIII UNI EN 14411\_L

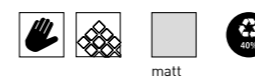

matte



25x76 cm  
9<sup>13/16</sup>"x29<sup>15/16</sup>"  
± 10 mm

# Flex

25x76 - 9<sup>13/16</sup> x 29<sup>15/16</sup>" 30x30 - 11<sup>13/16</sup> x 11<sup>13/16</sup>"

## Latte

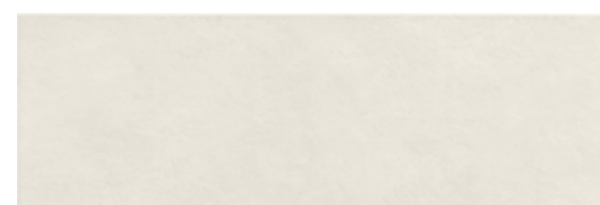

R02W 25x76

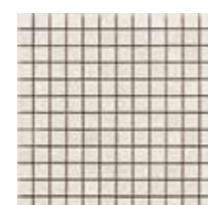

R06Z 30x30 Mosaico

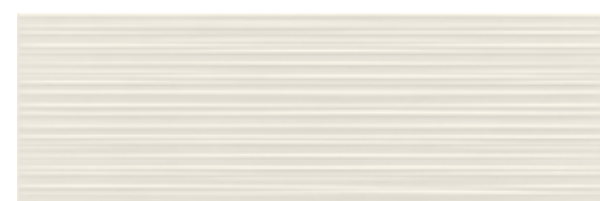

R03C 25x76 Struttura Fibra 3D



R038 25x76 Struttura Brick 3D

## Crema



R037 25x76

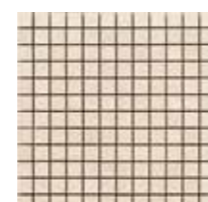

R07A 30x30 Mosaico



R03G 25x76 Struttura Fibra 3D



R03A 25x76 Struttura Brick 3D

## Cenere



R02X 25x76

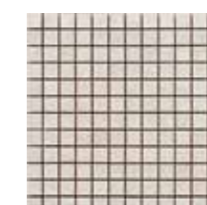

R07C 30x30 Mosaico



R039 25x76 Struttura Brick 3D

## Tabacco

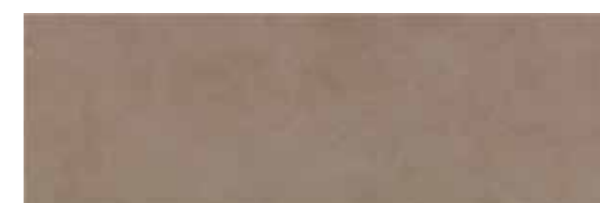

R02Z 25x76

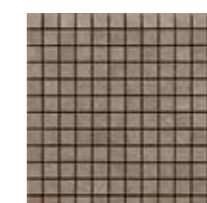

R07E 30x30 Mosaico



R03F 25x76 Struttura Fibra 3D

## Zafferano



R036 25x76



R07F 30x30 Mosaico

## Cielo



R02Y 25x76

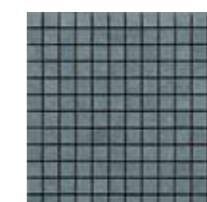

R07D 30x30 Mosaico



R03E 25x76 Struttura Fibra 3D

# Flex

25x76 - 9<sup>13/16</sup>"x29<sup>15/16</sup>" 30x30 - 11<sup>13/16</sup>"x11<sup>13/16</sup>"

## Decors



**R03H** 25X76 Decoro Fancy Latte

Abbinabile ai colori / Matching with colours / Mit den Grundfliesen kombinierbar / Peut s'associer aux carreaux de base de couleurs / Puede combinarse con los fondos / Сочетается с фоновой плиткой



**Latte** **Cenere** **Cielo** **Zafferano**



**R03J** 25X76 Decoro Fancy Crema

Abbinabile ai colori / Matching with colours / Mit den Grundfliesen kombinierbar / Peut s'associer aux carreaux de base de couleurs / Puede combinarse con los fondos / Сочетается с фоновой плиткой



**Crema** **Tabacco** **Zafferano**



**R12S** 25X76 Decoro Stripe Latte

Abbinabile ai colori / Matching with colours / Mit den Grundfliesen kombinierbar / Peut s'associer aux carreaux de base de couleurs / Puede combinarse con los fondos / Сочетается с фоновой плиткой

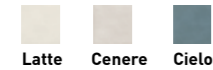

**Latte** **Cenere** **Cielo**



**R12T** 25X76 Decoro Stripe Crema

Abbinabile ai colori / Matching with colours / Mit den Grundfliesen kombinierbar / Peut s'associer aux carreaux de base de couleurs / Puede combinarse con los fondos / Сочетается с фоновой плиткой



**Crema** **Tabacco**

## TECH INFO

DECORI / DECORATIVE PIECES / DEKORE / DÉCORS / DECORACIONES / ДЕКОРЫ

### Decoro Stripe

Decoro con lustrati/metalli preziosi utilizzabile a rivestimento; si consiglia la pulizia con detersivi neutri, non abrasivi. È sconsigliata la posa nell'area doccia / Decors with lustres/precious metals used for covering; we recommend cleaning with neutral, non-abrasive detergents. Tiles should not be installed in the shower area / Dekor mit Glanzelementen/Edelmetallen für die Wandverkleidung; es wird die Reinigung mit neutralen, scheuermittelfreien Reinigungsmitteln empfohlen. Die Verlegung in der Duschnische wird nicht empfohlen / Décor avec lustres/métaux précieux à poser sur le mur. Lavage recommandé avec des détergents neutres, non abrasifs. Pose déconseillée dans la douche / Decoración con elementos brillantes/metales preciosos utilizable para revestir superficies; se recomienda limpiarla con detergentes neutros, no abrasivos. Se desaconseja colocarla en el área de la ducha / Декор с блестящим покрытием/ драгоценными металлами, используемый для облицовки; рекомендуется чистка с использованием нейтральных, неабразивных моющих средств. Не рекомендуется укладка в душевой зоне

### Mosaico

Mosaico assemblato su rete in fibra di vetro / Mosaic mesh - mounted on fibreglass / Auf Glasfasernetz geklebtes Mosaik / Mosaïque montée sur filet en fibre de verre / Mosaico enmallado sobre fibra de vidrio / Мозаика, собранная на сетке из стекловолокна

## IMBALLI / PACKAGING / VERPACKUNGEN / EMBALAJES / УПАКОВКИ

		scatole / box / karton / boîte / caja / короб			pallet / pallet / palette / palette / pallet / поддон			
		□	M²	KG	□	M²	KG	± mm
25x76		6	1,14	19,50	54	61,76	1050,00	10
25x76	Struttura Brick 3D	6	1,14	19,50	54	61,76	1050,00	10
25x76	Struttura Fibra 3D	6	1,14	19,50	54	61,76	1050,00	10
25x76	Decoro Fancy	6	1,14	19,50	54	61,76	1050,00	10
25x76	Decoro Stripe	2	0,38	4,00	-	-	-	-
30x30	Mosaico	4	0,36	6,38	60	21,60	383,00	10,5

WALL TILES

# Frame



## Frame

rivestimenti in pasta bianca / white bodywall tiles / wandfliesen aus weissen ton scherben / revetements en pate blanche / revestimientos en pasta blanca / облицовка из белой глины  
gruppo BIII UNI EN 14411\_L

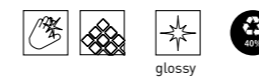

glossy



25x76 cm

9<sup>13</sup>/<sub>16</sub>" x 29<sup>15</sup>/<sub>16</sub>"

± 10 mm

R4XZ Frame Milk 25x76 - 9<sup>13</sup>/<sub>16</sub>" x 29<sup>15</sup>/<sub>16</sub>" - R4YL Frame Acqua Strutturato 25x76 - 9<sup>13</sup>/<sub>16</sub>" x 29<sup>15</sup>/<sub>16</sub>"  
R4YM Frame Decoro Majolica Milk 25x76 - 9<sup>13</sup>/<sub>16</sub>" x 29<sup>15</sup>/<sub>16</sub>" - R4CC Rewind Tabacco Rettificato 60x60 - 23<sup>5</sup>/<sub>8</sub>" x 23<sup>5</sup>/<sub>8</sub>"

# Frame

25x76 - 9<sup>13/16</sup>x29<sup>15/16</sup> 30x30 - 11<sup>13/16</sup>x11<sup>13/16</sup>

## Milk



R4XZ 25x76

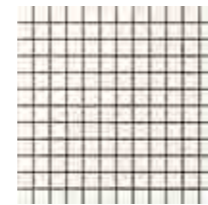

R4YZ 30x30 Mosaico

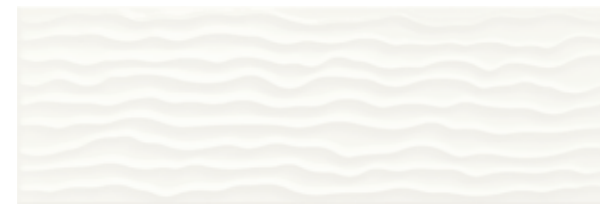

R4YH 25x76 Strutturato

## Cream



R4YA 25x76

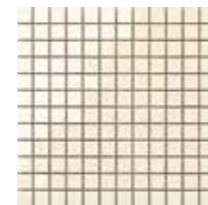

R4VA 30x30 Mosaico



R4YJ 25x76 Strutturato

## Khaki



R4YC 25x76

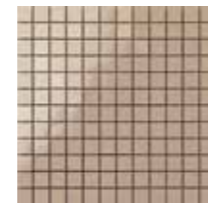

R4ZC 30x30 Mosaico



R4YK 25x76 Strutturato

## Plum



R4YD 25x76



R4ZD 30x30 Mosaico

## Sterling



R4YE 25x76

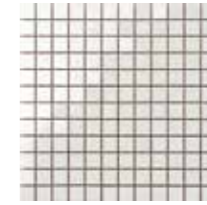

R4ZE 30x30 Mosaico



R53D 25x76 Strutturato

## Aqua



R4YF 25x76

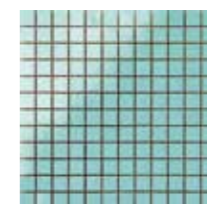

R4ZF 30x30 Mosaico



R4YL 25x76 Strutturato

## Indigo



R4YG 25x76

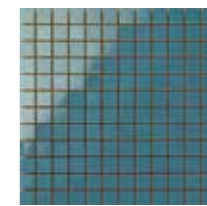

R4ZG 30x30 Mosaico

# Frame

25x76 - 9<sup>13/16</sup>"x29<sup>15/16</sup>" 30x30 - 11<sup>13/16</sup>"x11<sup>13/16</sup>"

## Decors



**R4YN** 25X76 Decoro Majolica Cream

Abbinabile ai colori / Matching with colours / Mit den Grundfliesen kombinierbar / Peut s'associer aux carreaux de base de couleurs / Puede combinarse con los fondos / Сочетается с фоновой плиткой

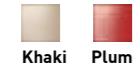

**Khaki Plum**



**R4YM** 25X76 Decoro Majolica Milk

Abbinabile ai colori / Matching with colours / Mit den Grundfliesen kombinierbar / Peut s'associer aux carreaux de base de couleurs / Puede combinarse con los fondos / Сочетается с фоновой плиткой

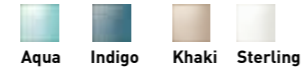

**Aqua Indigo Khaki Sterling**



**R50S** 25X76 Decoro Tratto Cream

Abbinabile ai colori / Matching with colours / Mit den Grundfliesen kombinierbar / Peut s'associer aux carreaux de base de couleurs / Puede combinarse con los fondos / Сочетается с фоновой плиткой



**Khaki Plum**



**R50R** 25X76 Decoro Tratto Milk

Abbinabile ai colori / Matching with colours / Mit den Grundfliesen kombinierbar / Peut s'associer aux carreaux de base de couleurs / Puede combinarse con los fondos / Сочетается с фоновой плиткой



**Aqua Indigo Sterling**



**R50U** 25X76 Decoro C3 Cream

Abbinabile ai colori / Matching with colours / Mit den Grundfliesen kombinierbar / Peut s'associer aux carreaux de base de couleurs / Puede combinarse con los fondos / Сочетается с фоновой плиткой



**Khaki Plum**



**R50T** 25X76 Decoro C3 Milk

Abbinabile ai colori / Matching with colours / Mit den Grundfliesen kombinierbar / Peut s'associer aux carreaux de base de couleurs / Puede combinarse con los fondos / Сочетается с фоновой плиткой



**Aqua Indigo**

## TECH INFO

DECORI / DECORATIVE PIECES / DEKORE / DÉCORS / DECORACIONES / ДЕКОРЫ

### Mosaico

Mosaico assemblato su rete in fibra di vetro / Mosaic mesh - mounted on fibreglass / Auf Glasfasernetz geklebtes Mosaik / Mosaïque montée sur filet en fibre de verre / Mosaico enmallado sobre fibra de vidrio / Мозаика, собранная на сетке из стекловолокна

## IMBALLI / PACKAGING / VERPACKUNGEN / EMBALAJES / УПАКОВКИ

		scatole / box / karton / boîte / caja / коробк			pallet / pallet / palette / palette / pallet / поддон			
		□	M²	KG	□	M²	KG	± mm
25x76		6	1,14	19,50	54	61,76	1050,00	10
25x76	Decoro Majolica	6	1,14	19,50	54	61,76	1050,00	10
25x76	Decoro Tratto	2	0,38	7,53	-	21,60	384,00	10
25x76	Decoro C3	1	0,57	12,32	-	-	-	-
30x30	Mosaico	4	0,36	9,73	80	28,80	778,36	10,5

WALL TILES

# Freestyle



## Freestyle

rivestimenti in pasta bianca / white bodywall tiles / wandfliesen aus weissen ton scherben / revetements en pate blanche / revestimientos en pasta blanca / облицовка из белой глины  
gruppo BIII UNI EN 14411\_L

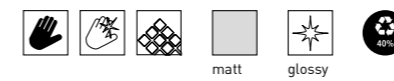

matt glossy



25x76 cm  
9<sup>13/16</sup>"x29<sup>15/16</sup>"  
± 10 mm

R6TU Freestyle Matt Struttura Fiore 3D 25x76 - 9<sup>13/16</sup>"x29<sup>15/16</sup>" - R56E Woodmania Ash 20x120 - 7<sup>7/8</sup>"x47<sup>1/4</sup>"



# Freestyle

25x76 - 9<sup>13/16</sup>" x 29<sup>15/16</sup>"

## White Matt

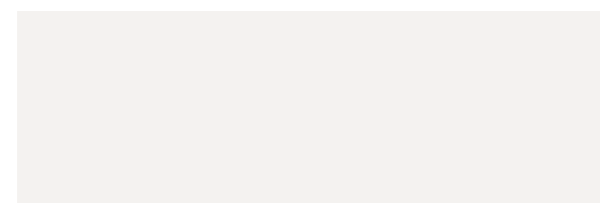

R2VH 25x76 Prestige



R6SA 25x76 Struttura Curva 3D



R6TU 25x76 Struttura Fiore 3D



R02C 25x76 Struttura Fibra 3D

## White Glossy

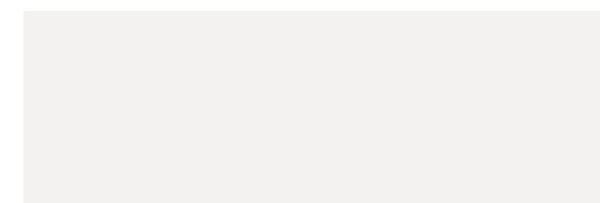

R2VF 25x76 Prestige



R5QY 25x76 Struttura Curva 3D



R75H 25x76 Struttura Fiore 3D

### IMBALLI / PACKAGING / VERPACKUNGEN / EMBALLAGES / EMBALAJES / УПАКОВКИ

		scatole / box / karton / boîte / caja / коробк			pallet / pallet / palette / palette / pallet / поддон			
		□	M <sup>2</sup>	KG	□	M <sup>2</sup>	KG	± mm
25x76		6	1,14	19,50	54	61,76	1050,00	10
25x76	Struttura 3D	6	1,14	19,50	54	61,76	1050,00	10

# Rewind Wall



## Rewind Wall

rivestimenti in pasta bianca / white bodywall tiles / wandfliesen aus weissen ton scherben / revetements en pate blanche / revestimientos en pasta blanca / облицовка из белой глины  
 gruppo BIII UNI EN 14411\_L

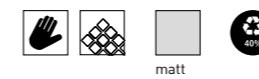

matte



25x76 cm

9<sup>13/16</sup>"x29<sup>15/16</sup>"

± 10 mm

**R4WS** Rewind Corda 25x76 - 9<sup>13/16</sup>"x29<sup>15/16</sup>" - **R4ZZ** Rewind Decoro Corda 25x76 - 9<sup>13/16</sup>"x29<sup>15/16</sup>" - **R4WZ** Rewind Peltro Strutturato 25x76 - 9<sup>13/16</sup>"x29<sup>15/16</sup>"  
**R4TG** Woodtale Betulla 30x120 - 11<sup>13/16</sup>"x47<sup>1/4</sup>" - **R4TM** Woodtale Betulla 20x120 - 7<sup>7/8</sup>"x47<sup>1/4</sup>" - **R4TS** Woodtale Betulla 15x120 - 5<sup>7/8</sup>"x47<sup>1/4</sup>"

CONCRETE EFFECT  
 Rewind > p.246

# Rewind Wall

25x76 - 9<sup>13/16</sup> x 29<sup>15/16</sup> 30x30 - 11<sup>13/16</sup> x 11<sup>13/16</sup>

## Corda



R4WS 25x76

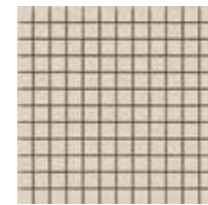

R4YU 30x30 Mosaico



R4WX 25x76 Strutturato

## Polvere



R4WW 25x76

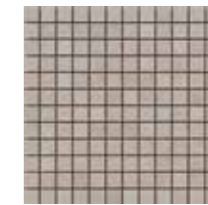

R4YY 30x30 Mosaico



R4XC 25x76 Strutturato

## Argilla



R4WT 25x76

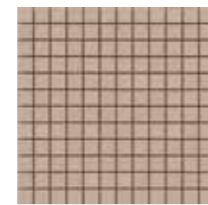

R4YV 30x30 Mosaico



R4WY 25x76 Strutturato

## Peltro



R4WU 25x76

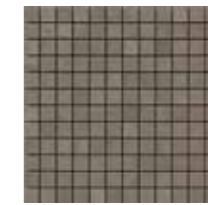

R4YW 30x30 Mosaico



R4WZ 25x76 Strutturato

## Vanilla



R4WV 25x76

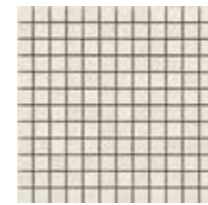

R4YX 30x30 Mosaico



R4XA 25x76 Strutturato

# Rewind Wall

25x76 - 9<sup>13/16</sup>"x29<sup>15/16</sup>" 30x30 - 11<sup>13/16</sup>"x11<sup>13/16</sup>"

## Decors



**R4XD** 25x76 Decoro Fiore Corda

Abbinabile ai colori / Matching with colours / Mit den Grundfliesen kombinierbar / Peut s'associer aux carreaux de base de couleurs / Puede combinarse con los fondos / Сочетается с фоновой плиткой

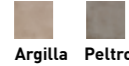

**Argilla Peltro**



**R4XE** 25x76 Decoro Fiore Vanilla

Abbinabile ai colori / Matching with colours / Mit den Grundfliesen kombinierbar / Peut s'associer aux carreaux de base de couleurs / Puede combinarse con los fondos / Сочетается с фоновой плиткой



**Polvere Peltro**



**R4ZZ** 25x76 Decoro Triangoli Corda

Abbinabile ai colori / Matching with colours / Mit den Grundfliesen kombinierbar / Peut s'associer aux carreaux de base de couleurs / Puede combinarse con los fondos / Сочетается с фоновой плиткой



**Argilla**



**R500** 25x76 Decoro Triangoli Vanilla

Abbinabile ai colori / Matching with colours / Mit den Grundfliesen kombinierbar / Peut s'associer aux carreaux de base de couleurs / Puede combinarse con los fondos / Сочетается с фоновой плиткой



**Polvere Peltro**



**R501** 25x76 Decoro C3 Corda

Abbinabile ai colori / Matching with colours / Mit den Grundfliesen kombinierbar / Peut s'associer aux carreaux de base de couleurs / Puede combinarse con los fondos / Сочетается с фоновой плиткой



**Argilla**



**R502** 25x76 Decoro C3 Vanilla

Abbinabile ai colori / Matching with colours / Mit den Grundfliesen kombinierbar / Peut s'associer aux carreaux de base de couleurs / Puede combinarse con los fondos / Сочетается с фоновой плиткой



**Polvere**

## TECH INFO

DECORI / DECORATIVE PIECES / DEKORE / DÉCORS / DECORACIONES / ДЕКОРЫ

### Mosaico

Mosaico assemblato su rete in fibra di vetro / Mosaic mesh - mounted on fibreglass / Auf Glasfasernetz geklebtes Mosaik / Mosaïque montée sur filet en fibre de verre / Mosaico enmallado sobre fibra de vidrio / Мозаика, собранная на сетке из стекловолокна

## IMBALLI / PACKAGING / VERPACKUNGEN / EMBALAJES / УПАКОВКИ

	scatole / box / karton / boîte / caja / короб			pallet / pallet / palette / palette / pallet / поддон			
	□	M²	KG	□	M²	KG	± mm
25x76	6	1,14	19,50	54	61,76	1050,00	10
25x76	6	1,14	20,40	54	61,56	1103,00	10
25x76	2	0,38	7,53	-	-	-	-
25x76	1	0,57	12,32	-	-	-	-
30x30	4	0,36	9,60	80	28,80	767,99	10,5

WALL TILES

# Trama



R5KF Rosa 25x76 - 9<sup>13/16</sup>"x29<sup>15/16</sup>" - R5RT Rosso Struttura Fibra 3D 25x76 - 9<sup>13/16</sup>"x29<sup>15/16</sup>"



## Trama

rivestimenti in pasta bianca / white bodywall tiles / wandfliesen aus weissen ton scherben / revetements en pate blanche / revestimientos en pasta blanca / облицовка из белой глины  
gruppo BIII UNI EN 14411\_L



semi-matt



25x76 cm  
9<sup>13/16</sup>"x29<sup>15/16</sup>"  
± 10 mm

# Trama

25x76 - 9<sup>13/16</sup> x 29<sup>15/16</sup>" 30x30 - 11<sup>13/16</sup> x 11<sup>13/16</sup>"

## Bianco



R5K9 25x76

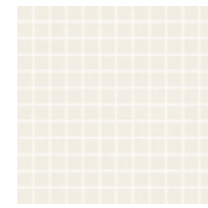

R5UW 30x30 Mosaico

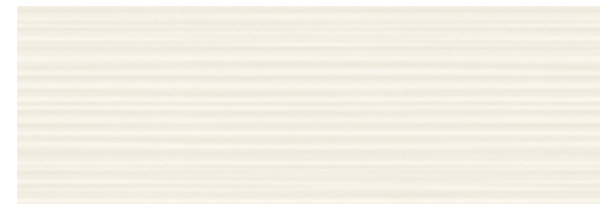

R5KQ 25x76 Struttura Fibra 3D

## Blu



R5KD 25x76

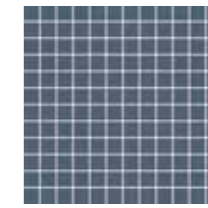

R5TQ 30x30 Mosaico



R5RU 25x76 Struttura Fibra 3D

## Grigio

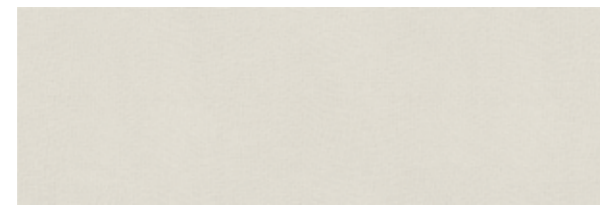

R5KA 25x76

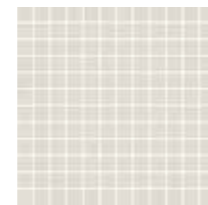

R5UV 30x30 Mosaico



R5KR 25x76 Struttura Fibra 3D

## Avorio



R5KG 25x76

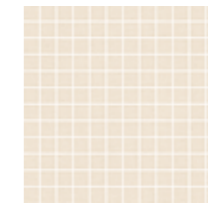

R5TM 30x30 Mosaico



R5KT 25x76 Struttura Fibra 3D

## Avio

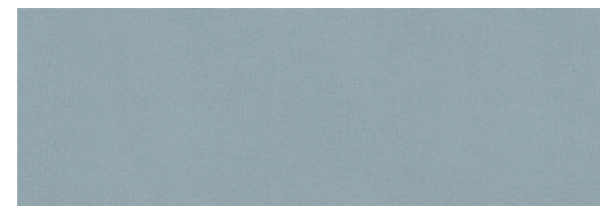

R5KC 25x76

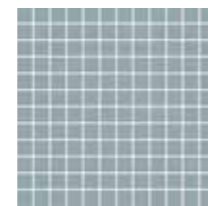

R5UU 30x30 Mosaico



R5KS 25x76 Struttura Fibra 3D

## Rosa

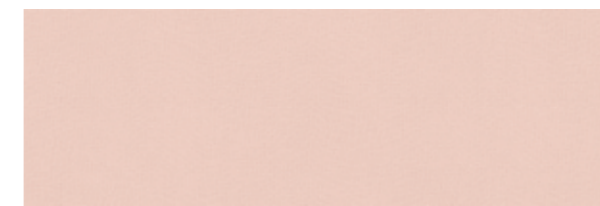

R5KF 25x76

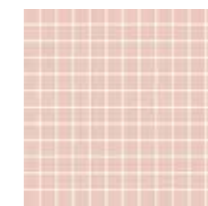

R5TN 30x30 Mosaico



R5KU 25x76 Struttura Fibra 3D

# Trama

25x76 - 9<sup>13/16</sup> x 29<sup>15/16</sup> 30x30 - 11<sup>13/16</sup> x 11<sup>13/16</sup>

## Rosso



**R5KE** 25x76

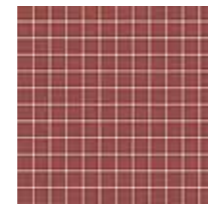

**R5TP** 30x30 Mosaico



**R5RT** 25x76 Struttura Fibra 3D



**R5KY** 25x76 Decoro Arazzo Avorio

Abbinabile ai colori / Matching with colours / Mit den Grundfliesen kombinierbar / Peut s'associer aux carreaux de base de couleurs / Puede combinarse con los fondos / Сочетается с фоновой плиткой

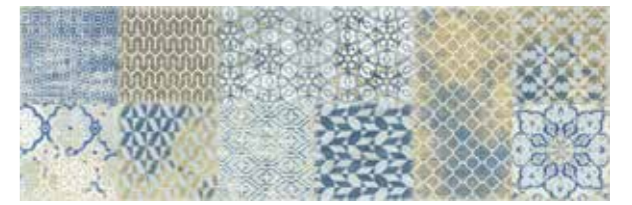
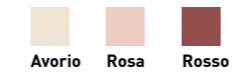

**R5KX** 25x76 Decoro Arazzo Bianco

Abbinabile ai colori / Matching with colours / Mit den Grundfliesen kombinierbar / Peut s'associer aux carreaux de base de couleurs / Puede combinarse con los fondos / Сочетается с фоновой плиткой



## Decors



**R627** 25x76 Decoro Filato Avorio

Abbinabile ai colori / Matching with colours / Mit den Grundfliesen kombinierbar / Peut s'associer aux carreaux de base de couleurs / Puede combinarse con los fondos / Сочетается с фоновой плиткой



**R628** 25x76 Decoro Filato Bianco

Abbinabile ai colori / Matching with colours / Mit den Grundfliesen kombinierbar / Peut s'associer aux carreaux de base de couleurs / Puede combinarse con los fondos / Сочетается с фоновой плиткой



**R5KW** 25x76 Decoro Stuoia Rosa

Abbinabile ai colori / Matching with colours / Mit den Grundfliesen kombinierbar / Peut s'associer aux carreaux de base de couleurs / Puede combinarse con los fondos / Сочетается с фоновой плиткой



**R5KV** 25x76 Decoro Stuoia Bianco

Abbinabile ai colori / Matching with colours / Mit den Grundfliesen kombinierbar / Peut s'associer aux carreaux de base de couleurs / Puede combinarse con los fondos / Сочетается с фоновой плиткой



# Trama



TRAMA | WALL TILES

TRAMA | WALL TILES

## TECH INFO

DECORI / DECORATIVE PIECES / DEKORE / DÉCORS /  
DECORACIONES / ДЕКОРЫ

### Mosaico

Mosaico assemblato su rete in fibra di vetro / Mosaic mesh - mounted  
on fibreglass / Auf Glasfasernetz geklebtes Mosaik / Mosaïque montée  
sur filet en fibre de verre / Mosaico enmallado sobre fibra de vidrio /  
Мозаика, собранная на сетке из стекловолокна

## IMBALLI / PACKAGING / VERPACKUNGEN / EMBALLAGES / EMBALAJES / УПАКОВКИ

		scatole / box / karton / boîte / caja / короб			pallet / pallet / palette / palette / pallet / поддон			
		□	M²	KG	□	M²	KG	± mm
25x76		6	1,14	19,50	54	61,56	1050,00	10
25x76	Struttura Fibra	6	1,14	19,50	54	61,56	1050,00	10
25x76	Decoro Stuoia	6	1,14	19,50	54	61,56	1050,00	10
25x76	Decoro Arazzo	6	1,14	19,50	54	61,56	1050,00	10
25x76	Decoro Filato	2	0,38	7,53	-	-	-	-
30x30	Mosaico	4	0,36	6,40	60	21,60	384,00	10

R5K9 Trama Bianco 25x76 - 9<sup>13</sup>/<sub>16</sub>"x29<sup>15</sup>/<sub>16</sub>" - R5KX Trama Decoro Arazzo Bianco 25x76 - 9<sup>13</sup>/<sub>16</sub>"x29<sup>15</sup>/<sub>16</sub>" - R5RZ Woodclassic Grigio 10x100 / 13x100 - 3<sup>15</sup>/<sub>16</sub>"x39<sup>3</sup>/<sub>8</sub>" / 5<sup>1</sup>/<sub>8</sub>"x39<sup>3</sup>/<sub>8</sub>"



WALL TILES

# Fantasy

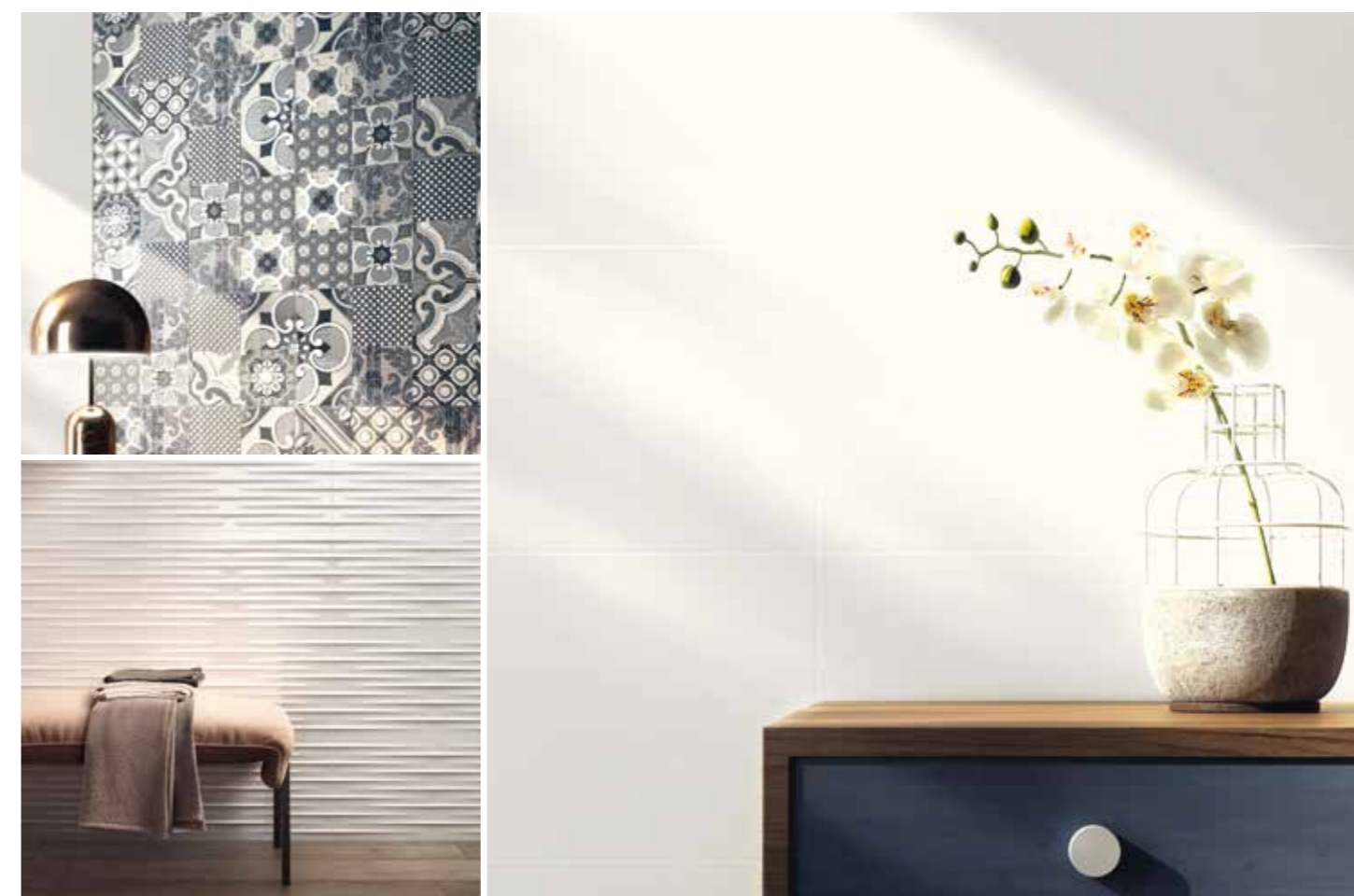

## Fantasy

rivestimenti in pasta bianca - rettificato / white bodywall tiles - rectified / wandfliesen aus weissen ton scherben - rektifiziert / revetements en pate blanche - rectifié / revestimientos en pasta blanca - rectificado / облицовка из белой глины - ректифицированный

gruppo BIII UNI EN 14411\_L



struttura semi-matt glossy



30x60 cm  
11<sup>13/16</sup>" x 23<sup>5/8</sup>"  
± 6 mm - 8 mm

R57F Fantasy Bianco Satinato Struttura Prisma 3D Rettificato 30x60 - 11<sup>13/16</sup>" x 23<sup>5/8</sup>" - R04A Cardoso Grigio Rettificato 60x60 - 23<sup>5/8</sup>" x 23<sup>5/8</sup>"

# Fantasy

30x60 - 11<sup>13/16</sup>"x23<sup>5/8</sup>" 30x30 - 11<sup>13/16</sup>"x11<sup>13/16</sup>"

## Bianco

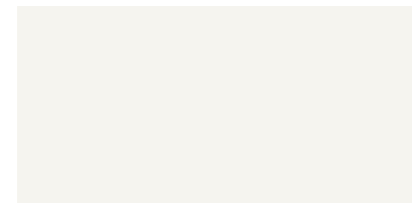

R57U 30x60 Satinato Rett

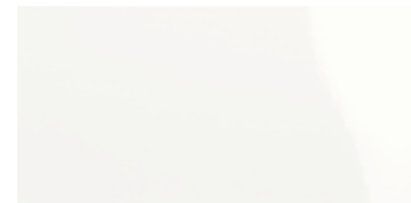

R57V 30x60 Lux Rett

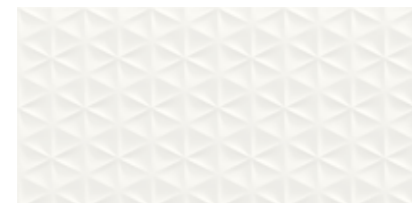

R57F 30x60 Satinato Struttura Prisma 3D Rett



R57G 30x60 Lux Struttura Prisma 3D Rett



R57H 30x60 Satinato Struttura Drappo 3D Rett



R57J 30x60 Lux Struttura Drappo 3D Rett



R57E 30x60 Satinato Struttura Onda 3D Rett

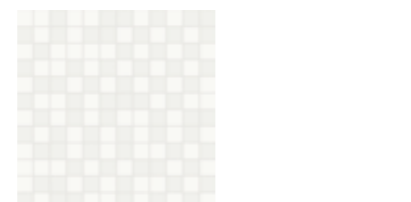

R01H 30x30 Mosaico

## Decors



R02P 30x60 Decoro Vintage Bianco



## TECH INFO

DECORI / DECORATIVE PIECES / DEKORE / DÉCORS /  
DECORACIONES / ДЕКОРЫ

### Mosaico

Mosaico assemblato su rete in fibra di vetro / Mosaic mesh - mounted  
on fibreglass / Auf Glasfasernetz geklebtes Mosaik / Mosaïque montée  
sur filet en fibre de verre / Mosaico enmallado sobre fibra de vidrio /  
Мозаика, собранная на сетке из стекловолокна

## IMBALLI / PACKAGING / VERPACKUNGEN / EMBALLAGES / EMBALAJES / УПАКОВКИ

	scatole / box / karton / boîte / caja / коробк			pallet / pallet / palette / palette / pallet / поддон			
	□	M²	KG	□	M²	KG	± mm
30x60	6	1,08	12,80	64	69,12	820,00	6
30x60	4	0,72	9,40	64	46,08	602,00	8
30x30	6	0,54	7,83	80	43,20	626,00	6
30x60	4	0,72	8,80	-	-	-	6

WALL TILES

# Brick Glossy



## Brick Glossy

rivestimenti in pasta bianca / white bodywall tiles / wandfliesen aus weissen ton scherben / revetements en pate blanche / revestimientos en pasta blanca / облицовка из белой глины  
gruppo BIII UNI EN 14411\_L

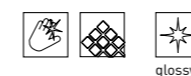

glossy



10x30 cm  
3<sup>15/16</sup>"x11<sup>13/16</sup>"  
± 7,5 mm

R46J Brick Glossy White 10x30 - 3<sup>15/16</sup>"x11<sup>13/16</sup>" - R4KS Brick Glossy Decoro Anthracite 10x30 - 3<sup>15/16</sup>"x11<sup>13/16</sup>" - R288 Concept Grigio Rettificato 60x60 - 23<sup>5/8</sup>"x23<sup>5/8</sup>"

# Brick Glossy

10x30 - 3<sup>15/16</sup>"x11<sup>13/16</sup>"

## White

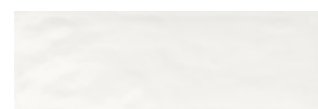

R4GJ 10x30 Glossy Rett

## Beige

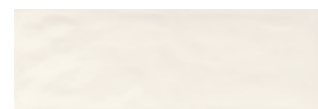

R4GK 10x30 Glossy Rett

## Grey



R4GL 10x30 Glossy Rett

## Anthracite

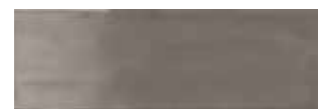

R4JG 10x30 Glossy Rett

## Purple



R4JF 10x30 Glossy Rett

## Blue



R4GM 10x30 Glossy Rett

## Black



R4GN 10x30 Glossy Rett



R4JH 12,5x30 AL.



R4JN 2,5x30 M.T.C.



R4JJ 12,5x30 AL.



R4JP 2,5x30 M.T.C.



R4JQ 2,5x30 M.T.C.



R4JU 2,5x30 M.T.C.



R4JM 12,5x30 AL.



R4JT 2,5x30 M.T.C.



R4JK 12,5x30 AL.



R4JR 2,5x30 M.T.C.



R4JL 12,5x30 AL.



R4JS 2,5x30 M.T.C.

## Decors



R4KT 10x30 Decoro Grey



R4KV 10x30 Decoro Beige

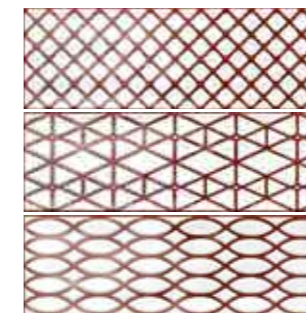

R4KU 10x30 Decoro Purple

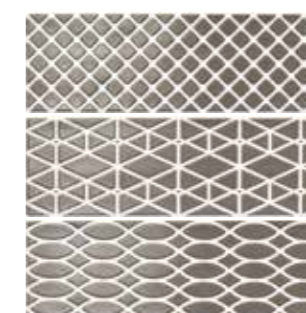

R4KS 10x30 Decoro Anthracite

## Brick Glossy



R4GK Beige 10x30 - 3<sup>15/16</sup>"x11<sup>13/16</sup>" - R4GN Black 10x30 - 3<sup>15/16</sup>"x11<sup>13/16</sup>"

## TECH INFO

DECORI / DECORATIVE PIECES / DEKORE / DÉCORS /  
DECORACIONES / ДЕКОРЫ

### Decoro

3 diversi soggetti / 3 different motifs / 3 verschiedene motive / 3 sujets  
différents / 3 temas diferentes / 3 различных рисунка

## IMBALLI / PACKAGING / VERPACKUNGEN / EMBALLAGES / EMBALAJES / УПАКОВКИ

		scatole / box / karton / boîte / caja / коробк			pallet / pallet / palette / palette / pallet / поддон			
		□	M²	KG	□	M²	KG	± mm
10x30		36	1,08	15,66	66	71,28	1033,68	7,5
10x30	Decoro	6	0,18	2,47	-	-	-	-
12,5x30	AL.	6	0,22	1,19	-	-	-	-
2,5x30	MT.C.	6	0,04	0,89	-	-	-	-

WALL TILES

# Touch



R2GX White 10x30 - 3<sup>15/16</sup> x 11<sup>13/16</sup> - R2HX White Strutturato 10x30 - 3<sup>15/16</sup> x 11<sup>13/16</sup>



## Touch

rivestimenti in pasta bianca / white bodywall tiles / wandfliesen aus weissen ton scherben / revetements en pate blanche / revestimientos en pasta blanca / облицовка из белой глины  
gruppo BIII UNI EN 14411\_L

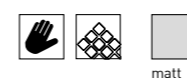

matte



10x30 cm  
3<sup>15/16</sup> x 11<sup>13/16</sup>  
± 7,5 mm

# Touch

10x30 - 3<sup>15/16"</sup>x11<sup>13/16"</sup>

## White

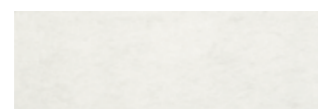

R2GX 10x30



R2HX 10x30 Strutturato

## Smoke



R2HC 10x30



R2JC 10x30 Strutturato

## Silver



R2GZ 10x30



R2HZ 10x30 Strutturato

## Ivory



R2HY 10x30 Strutturato

## Brown



R2JA 10x30 Strutturato

### IMBALLI / PACKAGING / VERPACKUNGEN / EMBALLAGES / EMBALAJES / УПАКОВКИ

	scatole / box / karton / boîte / caja / коробк			pallet / pallet / palette / palette / pallet / поддон			
	□	M²	KG	□	M²	KG	±mm
10x30	36	1,08	15,17	66	71,28	999,53	7,5
10x30 Strutturato	36	1,08	17,19	66	71,28	1134,86	7,5

# SMART FLOOR



- 590 Creek
- 594 Replace
- 598 Casablanca
- 602 Season
- 606 Sound
- 610 Escape
- 614 Freetime
- 618 Emilia
- 622 Galassia
- 626 Unitech



# Creek



R5K2 Beige Rettificato 60x120 - 23<sup>5/8</sup>"x47<sup>1/4</sup>"

gres porcellanato / porcelain stoneware / feinsteinzeug / grès cérame émaillé / gres porcelánico / керамогранит

gruppo BIa UNI EN 14411\_G



naturale/  
matt outdoor

FORMATI / SIZES / FORMATE / FORMATS / FORMATOS / ФОРМАТЫ

**60x120 cm**  
23<sup>5/8</sup>"x47<sup>1/4</sup>"  
± 9,5 mm

**75x75 cm**  
29<sup>1/2</sup>"x29<sup>1/2</sup>"  
± 9,5 mm

**60x60 cm**  
23<sup>5/8</sup>"x23<sup>5/8</sup>"  
± 9,5 mm

**45x45 cm**  
17<sup>11/16</sup>"x17<sup>11/16</sup>"  
± 9 mm

**30x60 cm**  
11<sup>13/16</sup>"x23<sup>5/8</sup>"  
± 9,5 mm

**SMART WALL**  
Creek Wall > p.636

## Bianco



**R5K0** 60x120 Rett  
**R9EQ** 75x75 Rett  
**R4EF** 60x60 Rett  
**R5J4** 45x45  
**R4HM** 30x60 Rett  
**R4NP** 30x60 Strutt Rett

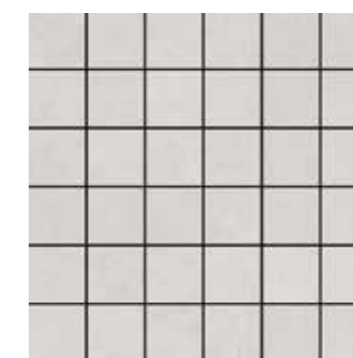

**R5LU** 30x30 Mosaico

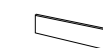

**R5MX** 7x60 BT.B.C.  
**R9FF** 7x75 BT.B.C.  
**R77Q** 8x45 BT.B.C.



**R5LZ** 15x60 E.ELLE Strutt

## Grigio



**R5JZ** 60x120 Rett  
**R9ER** 75x75 Rett  
**R4EE** 60x60 Rett  
**R5J3** 45x45  
**R4HL** 30x60 Rett  
**R4NN** 30x60 Strutt Rett

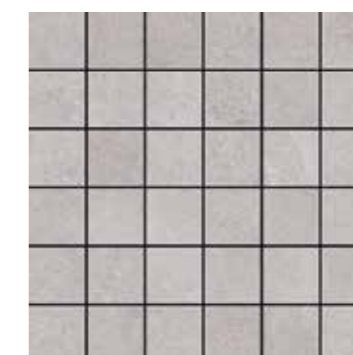

**R5LT** 30x30 Mosaico

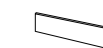

**R5MV** 7x60 BT.B.C.  
**R9FG** 7x75 BT.B.C.  
**R77R** 8x45 BT.B.C.

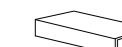

**R5LY** 15x60 E.ELLE Strutt

## Antracite



**R5JY** 60x120 Rett  
**R9EW** 75x75 Rett  
**R4ED** 60x60 Rett  
**R5J2** 45x45  
**R4HK** 30x60 Rett  
**R4NM** 30x60 Strutt Rett

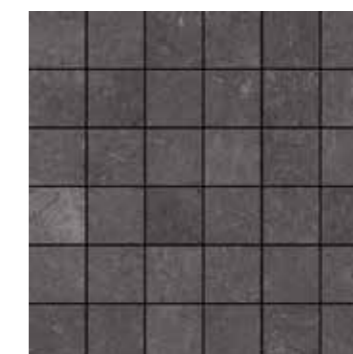

**R5LS** 30x30 Mosaico

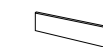

**R5MU** 7x60 BT.B.C.  
**R9FH** 7x75 BT.B.C.  
**R77S** 8x45 BT.B.C.



**R5LX** 15x60 E.ELLE Strutt

# Creek

60x120 - 23<sup>5/8</sup>"x47<sup>1/4</sup>" 75x75 - 29<sup>1/2</sup>"x29<sup>1/2</sup>" 60x60 - 23<sup>5/8</sup>"x23<sup>5/8</sup>" 45x45 - 17<sup>11/16</sup>"x17<sup>11/16</sup>" 30x60 - 11<sup>13/16</sup>"x23<sup>5/8</sup>" 30x30 - 11<sup>13/16</sup>"x11<sup>13/16</sup>"

## Avorio



**R5K1** 60x120 Rett  
**R9ES** 75x75 Rett  
**R4EG** 60x60 Rett  
**R5J5** 45x45  
**R4HN** 30x60 Rett  
**R4NQ** 30x60 Strutt Rett

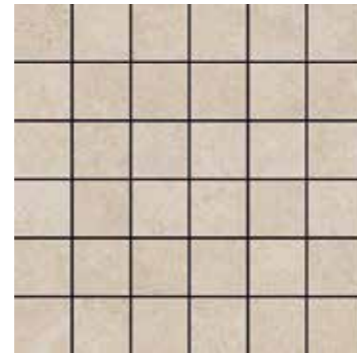

**R5LV** 30x30 Mosaico



**R5MY** 7x60 BT.B.C.  
**R9FK** 7x75 BT.B.C.  
**R77T** 8x45 BT.B.C.



**R5MA** 15x60 E.ELLE Strutt

## Beige



**R5K2** 60x120 Rett  
**R9ET** 75x75 Rett  
**R4EH** 60x60 Rett  
**R5J6** 45x45  
**R4KX** 30x60 Rett  
**R4NR** 30x60 Strutt Rett

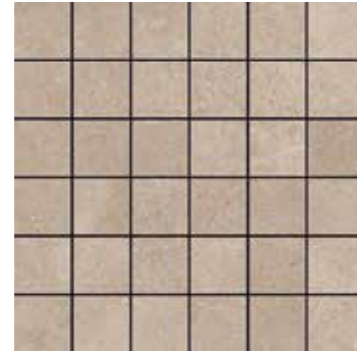

**R5LW** 30x30 Mosaico



**R5MZ** 7x60 BT.B.C.  
**R9FJ** 7x75 BT.B.C.  
**R77U** 8x45 BT.B.C.



**R5MC** 15x60 E.ELLE Strutt

## Decors



**R5HY** 60x60 Decoro Classic Grigio Rett

Abbinabile ai colori / Matching with colours / Mit den Grundfliesen kombinierbar / Peut s'associer aux carreaux de base de couleurs / Puede combinarse con los fondos / Сочетается с фоновой плиткой



**Bianco** **Grigio** **Antracite**



**R5HZ** 60x60 Decoro Classic Avorio Rett

Abbinabile ai colori / Matching with colours / Mit den Grundfliesen kombinierbar / Peut s'associer aux carreaux de base de couleurs / Puede combinarse con los fondos / Сочетается с фоновой плиткой



**Avorio** **Beige**

## TECH INFO

VARIAZIONI CROMATICHE / COLOUR VARIATIONS / FARBVARIATIONEN / VARIATIONS CHROMATIQUES / VARIACIONES CROMÁTICAS / ВАРИАНТЫ ОТТЕНКА



Apprezzabili differenze nell'aspetto di superficie e grafica all'interno della stessa produzione / Clearly distinguishable differences in texture and pattern within the same production run / Auffällige Unterschiede in Aussehen und Struktur innerhalb der gleichen Produktionscharge / Différences visibles au niveau de l'aspect et de la fantaisie entre les carreaux du même lot de production / Diferencias visibles en el aspecto de la superficie y los motivos dentro de un mismo lote de producción / заметные отличия вида поверхности и графики в одной и той же партии

DESTINAZIONE D'USO / INTENDED USE / ANWENDUNGSBEREICH / CHAMP D'APPLICATION / USO PREVISTO / НАЗНАЧЕНИЕ

### H (Naturale/Matt, Strutturato)

Materiali consigliati per sollecitazioni all'abrasione relativamente forti in ambienti anche non protetti da agenti graffianti / Materials recommended for relatively heavy abrasion levels, also in premises not protected against abrasive substances / Materials recommended for relatively heavy abrasion levels, also in premises not protected against abrasive substances / Empfohlen für starke Abriebbeanspruchungen in Bereichen auch ohne Kratzschutzbehandlung / Matériaux recommandés pour des locaux soumis à des fortes contraintes d'abrasion, même non protégés contre les agents abrasifs / Materiales recomendados para soportar esfuerzos de abrasión relativamente intensos incluso en espacios no protegidos frente a agentes abrasivos / Материалы рекомендованы для относительно сильного абразивного воздействия, в том числе в помещениях, не защищенных от царапающих элементов

DECORI / DECORATIVE PIECES / DEKORE / DÉCORS / DECORACIONES / ДЕКОРЫ

### Mosaico

Mosaico assemblato con tratto plastico / Spot-bonded mosaic / Punktverklebtes Mosaik / Mosaïque montée avec trait de colle / Mosaico colocado aplicando cola plástica / Мозаика с сегментами, выполненными из пластмассы - Мозаика, собранная на клеевой точке

PEZZI SPECIALI / TRIMS / SPEZIALTEILE / PIÈCES SPÉCIALES / PIEZAS ESPECIALES / СПЕЦИАЛЬНЫЕ ИЗДЕЛИЯ

### BT.B.C.

Battiscopa Becco Civetta ottenuto da taglio del fondo / Coved Edge Skirting Tile cut from plain tile / Sockelleiste, Halbrundstab, aus Grundfliese geschnitten / Plinthe bord rond découpée dans le fond / Rodapié canto romo conseguido mediante corte del fondo / Плинтус с закругленным краем, полученный из фоновой плитки

### E.Elle

Elemento ad Elle tagliato ed assemblato / Two-piece L-Tile / Schenkelplatte, geschnitten und zusammengesetzt / Élément en L coupé et assemblé / Elemento en forma de "L" cortado y montado / Г-образный элемент, состоящий из двух частей

CARATTERISTICHE / CHARACTERISTICS / EIGENSCHAFTEN / CARACTERISTIQUES / DATOS / ХАРАКТЕРИСТИКИ

<b>R9</b> Naturale/Matt <b>R11</b> Strutturato	<b>PENDULUM</b> classe 1 Naturale/Matt classe 3 Strutturato ptv > 36 Strutturato	<b>D-COF</b> > 0,42	<b>BCR</b> μ > 0,40
<b>C</b> Strutturato			
<b>≤ 175 mm²</b>			

CERTIFICAZIONI / CERTIFICATIONS / ZERTIFIZIERUNGEN / CERTIFICACIONES / СЕРТИФИКАЦИИ



IMBALLI / PACKAGING / VERPACKUNGEN / EMBALLAJES / УПАКОВКИ

		scatole / box / karton / boîte / caja / корбк			pallet / pallet / palette / palette / pallet / поддон			±mm
		□	M²	KG	□	M²	KG	
60x120	Rettificato	2	1,44	31,47	36	51,84	1132,85	9,5
75x75	Rettificato	2	1,13	24,50	42	47,25	1028,90	9,5
60x60	Rettificato	3	1,08	23,00	40	43,20	920,13	9,5
45x45		5	1,01	22,00	33	33,41	726,04	9
30x60	Naturale, Strutturato	6	1,08	22,99	48	51,84	1103,92	9,5
60x60	Decoro	3	1,08	21,43	40	43,20	857,14	9,5
30x30	Mosaico	4	0,36	8,00	80	28,80	640,00	9,5
7x60	BT.B.C.	15	9,00 ml	14,00	-	-	-	9,5
7x75	BT.B.C.	14	10,5 ml	20,00	-	-	-	9,5
8x45	BT.B.C.	30	13,50 ml	20,20	-	-	-	9
15x60	E.ELLE Strutt	4	0,36	8,00	-	-	-	-

# Replace

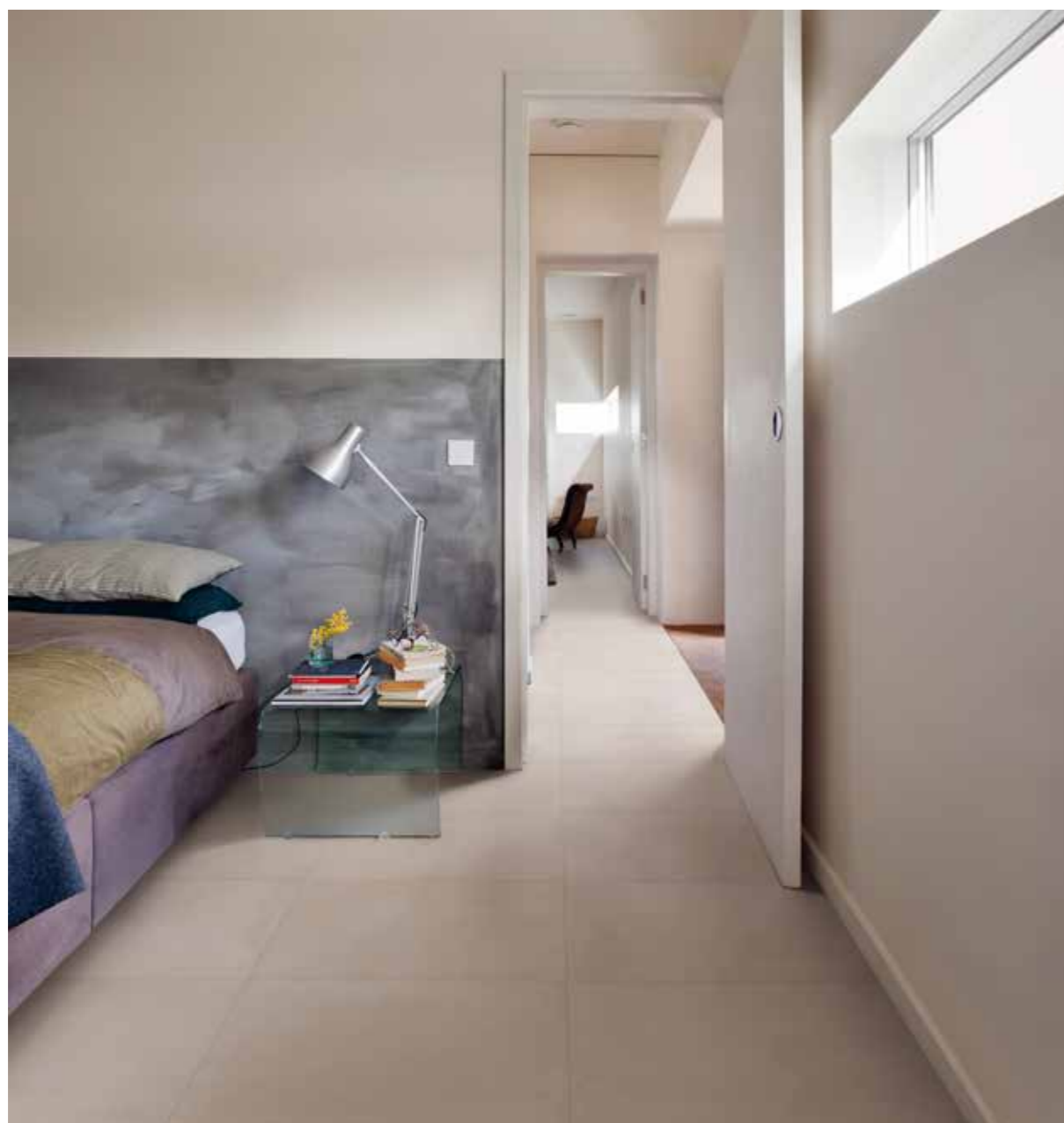

R4NW Beige Rettificato 60x60 - 23<sup>5/8</sup> x 23<sup>5/8</sup>

gres porcellanato / porcelain stoneware / feinsteinzeug / grès cérame émaillé / gres porcelánico / керамогранит

gruppo B1a UNI EN 14411\_G



FORMATI / SIZES / FORMATE / FORMATS / FORMATOS / ФОРМАТЫ

**60x120 cm**  
23<sup>5/8</sup> x 47<sup>1/4</sup>  
± 9,5 mm

**75x75 cm**  
29<sup>1/2</sup> x 29<sup>1/2</sup>  
± 9,5 mm

**60x60 cm**  
23<sup>5/8</sup> x 23<sup>5/8</sup>  
± 9,5 mm

**45x45 cm**  
17<sup>11/16</sup> x 17<sup>11/16</sup>  
± 9 mm

**30x60 cm**  
11<sup>13/16</sup> x 23<sup>5/8</sup>  
± 9,5 mm

**SMART WALL**  
Replace Wall > p.652

## Bianco



**R48Q** 60x120 Rett  
**R9EH** 75x75 Rett  
**R4NV** 60x60 Rett  
**R5JF** 60x60 Rett C2  
**R55K** 45x45  
**R4PF** 30x60 Rett  
**R4QE** 30x60 Strutt Rett

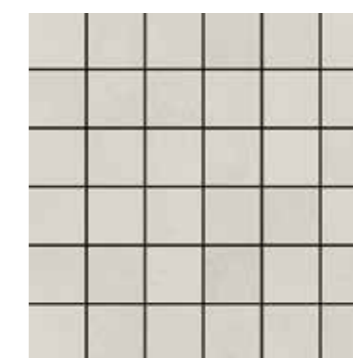

**R5ML** 30x30 Mosaico



**R5ND** 7x60 BT.B.C.  
**R9FA** 7x75 BT.B.C.  
**R77F** 8x45 BT.B.C.



**R5MR** 15x60 E.ELLE Strutt

## Grigio



**R47Y** 60x120 Rett  
**R9EM** 75x75 Rett  
**R4NT** 60x60 Rett  
**R5JD** 60x60 Rett C2  
**R55J** 45x45  
**R4PE** 30x60 Rett  
**R4QD** 30x60 Strutt Rett

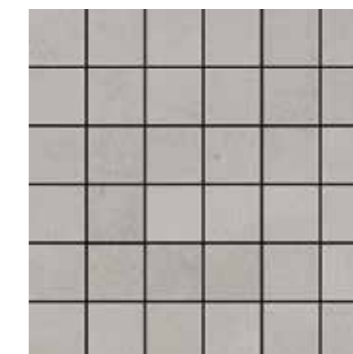

**R5MK** 30x30 Mosaico

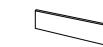

**R5NC** 7x60 BT.B.C.  
**R9FD** 7x75 BT.B.C.  
**R77G** 8x45 BT.B.C.



**R5MQ** 15x60 E.ELLE Strutt

## Antracite



**R47S** 60x120 Rett  
**R9EN** 75x75 Rett  
**R4NS** 60x60 Rett  
**R5JA** 60x60 Rett C2  
**R52J** 45x45  
**R4PD** 30x60 Rett  
**R4QC** 30x60 Strutt Rett



**R5MJ** 30x30 Mosaico

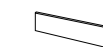

**R5NA** 7x60 BT.B.C.  
**R9FC** 7x75 BT.B.C.  
**R77H** 8x45 BT.B.C.



**R5MP** 15x60 E.ELLE Strutt

# Replace

60x120 - 23<sup>5/8</sup> x 47<sup>1/4</sup> 75x75 - 29<sup>1/2</sup> x 29<sup>1/2</sup> 60x60 - 23<sup>5/8</sup> x 23<sup>5/8</sup> 45x45 - 17<sup>11/16</sup> x 17<sup>11/16</sup> 30x60 - 11<sup>13/16</sup> x 23<sup>5/8</sup> 30x30 - 11<sup>13/16</sup> x 11<sup>13/16</sup>

## Beige



**R48T** 60x120 Rett  
**R9EJ** 75x75 Rett  
**R4NW** 60x60 Rett  
**R5JG** 60x60 Rett C2  
**R55L** 45x45  
**R4PG** 30x60 Rett  
**R4VY** 30x60 Strutt Rett

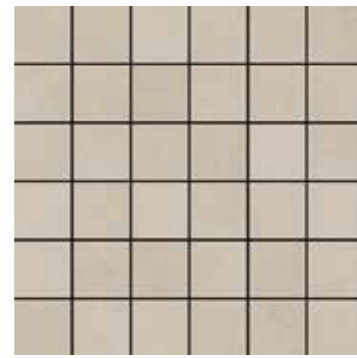

**R5MM** 30x30 Mosaico



**R5NE** 7x60 BT.B.C.  
**R9EZ** 7x75 BT.B.C.  
**R77J** 8x45 BT.B.C.

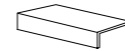

**R5MS** 15x60 E.ELLE Strutt

## TECH INFO

VARIAZIONI CROMATICHE / COLOUR VARIATIONS / FARBVARIATIONEN / VARIATIONS CHROMATIQUES / VARIACIONES CROMÁTICAS / ВАРИАНТЫ ОТТЕНКА



Apprezzabili differenze nell'aspetto di superficie e grafica all'interno della stessa produzione / Clearly distinguishable differences in texture and pattern within the same production run / Auffällige Unterschiede in Aussehen und Struktur innerhalb der gleichen Produktionscharge / Différences visibles au niveau de l'aspect et de la fantaisie entre les carreaux du même lot de production / Diferencias visibles en el aspecto de la superficie y los motivos dentro de un mismo lote de producción / заметные отличия вида поверхности и графики в одной и той же партии

DESTINAZIONE D'USO / INTENDED USE / ANWENDUNGSBEREICH / CHAMP D'APPLICATION / USO PREVISTO / НАЗНАЧЕНИЕ

### G (Beige: Naturale/Matt, Strutturato)

Materiali consigliati per locali sottoposti a sollecitazioni all'abrasione medio pesanti come: case individuali, commerciale leggero / Materials recommended for premises with medium-heavy abrasion levels, such as: detached homes, light-traffic commercial premises / Empfohlen für Räume mit mittelschwerer Abriebbeanspruchung wie: Einfamilienhäuser, leicht beanspruchte Gewerbebereiche / Matériaux recommandés pour des locaux soumis à des contraintes d'abrasion moyennes et fortes comme : maisons particulières, espaces commerciaux soumis à un trafic léger, etc / Materiales recomendados para locales sometidos a esfuerzos de abrasión medio-pesados, como casas unifamiliares y locales comerciales de tráfico ligero / Материалы рекомендованы для использования в частных домах и коммерческих помещениях, подверженных средне-сильному абразивному воздействию

### H (Bianco, Grigio, Antracite, Tortora: Naturale/Matt, Strutturato)

Materiali consigliati per sollecitazioni all'abrasione relativamente forti in ambienti anche non protetti da agenti graffianti / Materials recommended for relatively heavy abrasion levels, also in premises not protected against abrasive substances / Materials recommended for relatively heavy abrasion levels, also in premises not protected against abrasive substances / Empfohlen für starke Abriebbeanspruchungen in Bereichen auch ohne Kratzschutzbehandlung / Matériaux recommandés pour des locaux soumis à des fortes contraintes d'abrasion, même non protégés contre les agents abrasifs / Materiales recomendados para soportar esfuerzos de abrasión relativamente intensos incluso en espacios no protegidos frente a agentes abrasivos / Материалы рекомендованы для относительно сильного абразивного воздействия, в том числе в помещениях, не защищенных от царапающих элементов

CLASSIFICAZIONE / CLASSIFICATION / KLASSIFIZIERUNG / CLASSIFICATION / CLASIFICACIÓN / КЛАССИФИКАЦИЯ

### C2

Classificazione in base alla normativa spagnola UNE - ENV 12633:2003 / Classification according to Spanish standard UNE - ENV 12633:2003 / Klassifizierung gemäß der spanischen Norm UNE - ENV 12633:2003 / Classification selon la norme espagnole UNE-ENV 12633:2003 / Clasificación con arreglo a la norma española UNE - ENV 12633:2003 / Классификация в соответствии с испанским стандартом UNE - ENV 12633:2003

DECORI / DECORATIVE PIECES / DEKORE / DÉCORS / DECORACIONES / ДЕКОРЫ

### Mosaico

Mosaico assemblato con tratto plastico / Spot-bonded mosaic / Punktverklebtes Mosaik / Mosaïque montée avec trait de colle / Mosaico colocado aplicando cola plástica / Мозаика с сегментами, выполненными из пластмассы - Мозаика, собранная на клеевой точке

PEZZI SPECIALI / TRIMS / SPEZIALTEILE / PIÈCES SPÉCIALES / PIEZAS ESPECIALES / СПЕЦИАЛЬНЫЕ ИЗДЕЛИЯ

### BT.B.C.

Battiscopa Becco Civetta ottenuto da taglio del fondo / Coved Edge Skirting Tile cut from plain tile / Sockelleiste, Halbrundstab, aus Grundfliese geschnitten / Plinthe bord rond découpée dans le fond / Rodapié canto romo conseguido mediante corte del fondo / Плинтус с закругленным краем, полученный из фоновой плитки

### E.Elle

Elemento ad Elle tagliato ed assemblato / Two-piece L-Tile / Schenkelplatte, geschnitten und zusammengesetzt / Élément en L coupé et assemblé / Elemento en forma de "L" cortado y montado / Г-образный элемент, состоящий из двух частей

## Tortora



**R48N** 60x120 Rett  
**R9EK** 75x75 Rett  
**R4NU** 60x60 Rett  
**R5JH** 60x60 Rett C2  
**R55M** 45x45  
**R4PH** 30x60 Rett  
**R4VZ** 30x60 Strutt Rett



**R5MN** 30x30 Mosaico



**R5NF** 7x60 BT.B.C.  
**R9F6** 7x75 BT.B.C.  
**R77K** 8x45 BT.B.C.



**R5MT** 15x60 E.ELLE Strutt

## Decors



**R5J0** 60x60 Decoro Moderno Grigio Rett

Abbinabile ai colori / Matching with colours / Mit den Grundfliesen kombinierbar / Peut s'associer aux carreaux de base de couleurs / Puede combinarse con los fondos / Сочетается с фоновой плиткой



**Bianco** **Grigio** **Antracite**



**R5J1** 60x60 Decoro Moderno Beige Rett

Abbinabile ai colori / Matching with colours / Mit den Grundfliesen kombinierbar / Peut s'associer aux carreaux de base de couleurs / Puede combinarse con los fondos / Сочетается с фоновой плиткой



**Beige** **Tortora**

CARATTERISTICHE / CHARACTERISTICS / EIGENSCHAFTEN / CARACTERISTIQUES / DATOS / ХАРАКТЕРИСТИКИ

<b>R9</b> Naturale/Matt <b>R11</b> Strutturato	<b>PENDULUM</b> classe 1 Naturale/Matt classe 2 C2 classe 3 Strutturato ptv > 36 Strutturato	<b>D-COF</b> > 0,42	<b>BCR</b> μ > 0,40
<b>C</b> Strutturato			
≤ 175 mm <sup>2</sup>			

CERTIFICAZIONI / CERTIFICATIONS / ZERTIFIZIERUNGEN / CERTIFICATIONS / CERTIFICACIONES / СЕРТИФИКАЦИИ



IMBALLI / PACKAGING / VERPACKUNGEN / EMBALLAJES / УПАКОВКИ

		scatole / box / karton / boîte / caja / корбк			pallet / pallet / palette / palette / pallet / поддон			
		□	M <sup>2</sup>	KG	□	M <sup>2</sup>	KG	±mm
60x120	Rettificato	2	1,44	31,47	36	51,84	1132,85	9,5
75x75	Rettificato	2	1,13	24,50	42	47,25	1028,96	9,5
60x60	Rettificato	3	1,08	23,00	40	43,20	920,13	9,5
45x45		5	1,01	22,00	33	33,41	726,04	9
30x60	Naturale, Strutturato	6	1,08	22,99	48	51,84	1103,92	9,5
60x60	Decoro	3	1,08	21,93	40	43,20	877,14	9,5
30x30	Mosaico	4	0,36	8,00	80	28,80	640,00	9,5
7x60	BT.B.C.	15	9,00 ml	14,00	-	-	-	9,5
7x75	BT.B.C.	14	10,5 ml	20,00	-	-	-	9,5
8x45	BT.B.C.	30	13,50 ml	20,20	-	-	-	9
15x60	E.ELLE Strutt	4	0,36	8,00	-	-	-	-

# Casablanca



R3KM BG Rettificato 60x60 - 23<sup>5/8</sup>"x23<sup>5/8</sup>"

gres porcellanato - rettificato monocalibro / porcelain stoneware - rectified monocaliber / feinsteinzeug - rektifiziert, in einem werkmaß / grès cérame émaillé - rectifié monocalibre / gres porcelánico - rectificado monocalibre / керамогранит - ректифицированный монокалиберный  
 45x45 - 33,3x33,3  
 gres porcellanato / porcelain stoneware / feinsteinzeug / grès cérame émaillé / gres porcelánico / керамогранит

gruppo BIa UNI EN 14411\_G

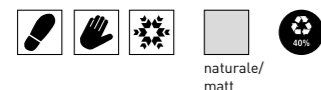

naturale/  
matt

FORMATI / SIZES / FORMATE / FORMATS / FORMATOS / ФОРМАТЫ

**60x60 cm**  
23<sup>5/8</sup>"x23<sup>5/8</sup>"  
± 9 mm

**45x45 cm**  
17<sup>11/16</sup>"x17<sup>11/16</sup>"  
± 9 mm

**30x60 cm**  
11<sup>13/16</sup>"x23<sup>5/8</sup>"  
± 9 mm

**33,3x33,3 cm**  
13<sup>1/8</sup>"x13<sup>1/8</sup>"  
± 8 mm

**SMART WALL**  
Casablanca Wall > p.660

BG



R3KM 60x60 Rett  
R3KZ 45x45  
R3KT 30x60 Rett  
R51P 33,3x33,3

R3LN 7x60 BT.B.C.

R53X 8x33,3 BT.B.C.  
R3LG 8x45 BT.B.C.

CR



R3KN 60x60 Rett  
R3LA 45x45  
R3KU 30x60 Rett  
R51Q 33,3x33,3

R3LP 7x60 BT.B.C.

R53Y 8x33,3 BT.B.C.  
R3LH 8x45 BT.B.C.

MA



R3KP 60x60 Rett  
R3LC 45x45  
R3KV 30x60 Rett  
R51R 33,3x33,3

R3LQ 7x60 BT.B.C.

R53Z 8x33,3 BT.B.C.  
R3LJ 8x45 BT.B.C.

# Casablanca

60x60 - 23<sup>5/8</sup> x 23<sup>5/8</sup> 45x45 - 17<sup>11/16</sup> x 17<sup>11/16</sup> 30x60 - 11<sup>13/16</sup> x 23<sup>5/8</sup> 33,3x33,3 - 13<sup>1/8</sup> x 13<sup>1/8</sup>

GR



**R3KQ** 60x60 Rett  
**R3LD** 45x45  
**R3KW** 30x60 Rett  
**R51S** 33,3x33,3

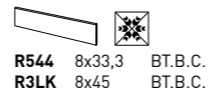
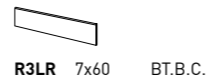

AN



**R3KR** 60x60 Rett  
**R3LE** 45x45  
**R3KX** 30x60 Rett  
**R51T** 33,3x33,3

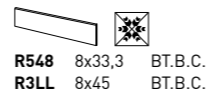
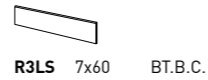

NE



**R3KS** 60x60 Rett  
**R3LF** 45x45  
**R3KY** 30x60 Rett  
**R51U** 33,3x33,3

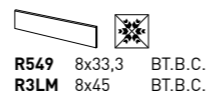
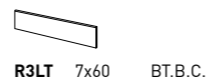

## TECH INFO

DESTINAZIONE D'USO / INTENDED USE / ANWENDUNGSBEREICH / CHAMP D'APPLICATION / USO PREVISTO / НАЗНАЧЕНИЕ

### F (MA, NE: Naturale/Matt)

Materiali consigliati per qualsiasi locale di un'abitazione che non abbia collegamenti diretti con l'esterno o accessi non protetti da zerbini. Medie sollecitazioni all'abrasione / Tiles suitable for any room of a house without direct access from the outside or access not protected by doormats. Mean stress abrasive wear / Für alle Räume des Wohnbereichs empfohlen, zu denen man keinen direkten Zutritt von außen hat oder welche nicht durch Fußteppiche abgegrenzt sind. Mittlere Abriebbeanspruchung / Matériaux conseillés pour toutes les pièces d'une maison qui n'a pas d'accès directs par l'extérieur ou non protégés par des paillasons. Abrasion sous contraintes moyennes / Materiales aconsejados para cualquier habitación de una vivienda sin accesos directos desde el exterior o accesos no protegidos por felpudos. Esfuerzos medianos por abrasión / Materiales recomendados para cualquier habitación de una vivienda sin accesos directos desde el exterior o accesos no protegidos por felpudos. Esfuerzos medianos por abrasión / Материалы рекомендованы для любых жилых помещений, не имеющих прямого выхода на улицу или же доступа без входных ковриков. Среднее абразивное воздействие

### G (BG, CR, GR, AN: Naturale/Matt)

Materiali consigliati per locali sottoposti a sollecitazioni all'abrasione medio pesanti come: case individuali, commerciale leggero / Materials recommended for premises with medium-heavy abrasion levels, such as: detached homes, light-traffic commercial premises / Empfohlen für Räume mit mittelschwerer Abriebbeanspruchung wie: Einfamilienhäuser, leicht beanspruchte Gewerbebereiche / Matériaux recommandés pour des locaux soumis à des contraintes d'abrasion moyennes et fortes comme : maisons particulières, espaces commerciaux soumis à un trafic léger, etc / Materiales recomendados para locales sometidos a esfuerzos de abrasión medio-pesados, como casas unifamiliares y locales comerciales de tráfico ligero / Материалы рекомендованы для использования в частных домах и коммерческих помещениях, подверженных средне-сильному абразивному воздействию

PEZZI SPECIALI / TRIMS / SPEZIALTEILE / PIÈCES SPÉCIALES / PIEZAS ESPECIALES / СПЕЦИАЛЬНЫЕ ИЗДЕЛИЯ

### BT.B.C.

Battiscopa Becco Civetta ottenuto da taglio del fondo / Coved Edge Skirting Tile cut from plain tile / Sockelleiste, Halbrundstab, aus Grundfliese geschnitten / Plinthe bord rond découpée dans le fond / Rodapié canto romo conseguido mediante corte del fondo / Плинтус с закругленным краем, полученный из фоновой плитки



### BT.B.C.

Battiscopa Becco Civetta ottenuto per pressatura / Press-formed Coved Edge Skirting Tile / Sockelleiste, Halbrundstab, gepresst / Plinthe bord rond obtenue par pressage / Rodapié canto romo conseguido mediante prensado / Плинтус с закругленным краем, полученный прессованием

CARATTERISTICHE / CHARACTERISTICS / EIGENSCHAFTEN / CARACTERISTIQUES / DATOS / ХАРАКТЕРИСТИКИ



PENDULUM  
 classe 1

CERTIFICAZIONI / CERTIFICATIONS / ZERTIFIZIERUNGEN / CERTIFICACIONES / СЕРТИФИКАЦИИ



IMBALLI / PACKAGING / VERPACKUNGEN / EMBALLAGES / EMBALAJES / УПАКОВКИ

	scatole / box / karton / boîte / caja / короб			pallet / pallet / palette / palette / pallet / поддон			
	□	M²	KG	□	M²	KG	± mm
60x60	3	1,08	23,00	40	43,20	920,00	9
45x45	5	1,01	19,58	33	33,41	646,27	9
30x60	6	1,08	19,55	48	51,84	938,45	9
33,3x33,3	16	1,77	29,71	38	67,42	1129,14	8
7x60							
7x60							
8x33,3							
8x33,3							
8x45							
8x45							

# Season



R3RR Grey Rettificato 60x60 - 23<sup>5/8</sup>"x23<sup>5/8</sup>"

**60x60 - 30x60**  
 gres porcellanato - rettificato monocalibro / porcelain stoneware - rectified monocaliber / feinsteinzeug - rektifiziert, in einem werkmaß / grès cérame émaillé - rectifié monocalibre / gres porcelánico - rectificado monocalibre / керамогранит - ректифицированный монокалиберный

**45x45 - 33,3x33,3 - 30x60 (outdoor)**  
 gres porcellanato / porcelain stoneware / feinsteinzeug / grès cérame émaillé / gres porcelánico / керамогранит

gruppo Bia UNI EN 14411\_G

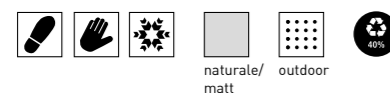

naturale/  
 matt outdoor

FORMATI / SIZES / FORMATE / FORMATS / FORMATOS / ФОРМАТЫ

<b>60x60 cm</b> 23 <sup>5/8</sup> "x23 <sup>5/8</sup> " ± 9,5 mm	<b>45x45 cm</b> 17 <sup>11/16</sup> "x17 <sup>11/16</sup> " ± 9 mm	<b>30x60 cm</b> 11 <sup>13/16</sup> "x23 <sup>5/8</sup> " ± 9,5 mm	<b>33,3x33,3 cm</b> 13 <sup>1/8</sup> "x13 <sup>1/8</sup> " ± 8 mm
--	--	--	--

## White



R3RN 60x60 Rett  
 R3SK 45x45  
 R3RT 30x60 Rett  
 R46T 30x60 Strutt  
 R3RY 33,3x33,3  
 R3SE 33,3x33,3 Strutt



R3SQ 7x60 BT.B.C.  
 R3TA 8x45 BT.B.C.  
 R3SV 8x33,3 BT.B.C.\*

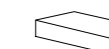

R3TG 15x33,3 E.ELLE

## Beige



R3RP 60x60 Rett  
 R3SL 45x45  
 R3RU 30x60 Rett  
 R46U 30x60 Strutt  
 R3RZ 33,3x33,3  
 R3SF 33,3x33,3 Strutt

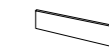

R3SR 7x60 BT.B.C.  
 R3TC 8x45 BT.B.C.  
 R3SW 8x33,3 BT.B.C.\*

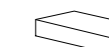

R3TH 15x33,3 E.ELLE

## Taupe



R3RQ 60x60 Rett  
 R3SM 45x45  
 R3RV 30x60 Rett  
 R46V 30x60 Strutt  
 R3SA 33,3x33,3  
 R3SG 33,3x33,3 Strutt



R3SS 7x60 BT.B.C.  
 R3TD 8x45 BT.B.C.  
 R3SX 8x33,3 BT.B.C.\*

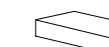

R3TJ 15x33,3 E.ELLE

# Season

60x60 - 23<sup>9/16</sup> x 23<sup>9/16</sup> 45x45 - 17<sup>11/16</sup> x 17<sup>11/16</sup> 30x60 - 11<sup>13/16</sup> x 23<sup>9/16</sup> 33,3x33,3 - 13<sup>1/8</sup> x 13<sup>1/8</sup>

## Grey



**R3RR** 60x60 Rett  
**R3SN** 45x45  
**R3RW** 30x60 Rett  
**R46W** 30x60 Strutt  
**R3SC** 33,3x33,3  
**R3SH** 33,3x33,3 Strutt



**R3ST** 7x60 BT.B.C.  
**R3TE** 8x45 BT.B.C.  
**R3SY** 8x33,3 BT.B.C.\*



**R3TK** 15x33,3 E.ELLE

## Anthracite



**R3RS** 60x60 Rett  
**R3SP** 45x45  
**R3RX** 30x60 Rett  
**R46X** 30x60 Strutt  
**R3SD** 33,3x33,3  
**R3SJ** 33,3x33,3 Strutt



**R3SU** 7x60 BT.B.C.  
**R3TF** 8x45 BT.B.C.  
**R3SZ** 8x33,3 BT.B.C.\*



**R3TL** 15x33,3 E.ELLE

## TECH INFO

DESTINAZIONE D'USO / INTENDED USE / ANWENDUNGSBEREICH / CHAMP D'APPLICATION / USO PREVISTO / НАЗНАЧЕНИЕ

### F (Anthracite: Naturale/Matt)

Materiali consigliati per qualsiasi locale di un'abitazione che non abbia collegamenti diretti con l'esterno o accessi non protetti da zerbini. Medie sollecitazioni all'abrasione / Tiles suitable for any room of a house without direct access from the outside or access not protected by doormats. Mean stress abrasive wear / Für alle Räume des Wohnbereichs empfohlen, zu denen man keinen direkten Zutritt von außen hat oder welche nicht durch Fußteppiche abgegrenzt sind. Mittlere Abriebbeanspruchung / Matériaux conseillés pour toutes les pièces d'une maison qui n'a pas d'accès directs par l'extérieur ou non protégés par des paillasons. Abrasion sous contraintes moyennes / Materiales aconsejados para cualquier habitación de una vivienda sin accesos directos desde el exterior o accesos no protegidos por felpudos. Esfuerzos medianos por abrasión / Материалы рекомендованы для любых жилых помещений, не имеющих прямого выхода на улицу или же доступа без входных ковриков. Среднее абразивное воздействие

### G (White, Beige, Taupe, Grey: Naturale/Matt, Strutturato Anthracite: Strutturato)

Materiali consigliati per locali sottoposti a sollecitazioni all'abrasione medio pesanti come: case individuali, commerciale leggero / Materials recommended for premises with medium-heavy abrasion levels, such as: detached homes, light-traffic commercial premises / Empfohlen für Räume mit mittelschwerer Abriebbeanspruchung wie: Einfamilienhäuser, leicht beanspruchte Gewerbebereiche / Matériaux recommandés pour des locaux soumis à des contraintes d'abrasion moyennes et fortes comme : maisons particulières, espaces commerciaux soumis à un trafic léger, etc / Materiales recomendados para locales sometidos a esfuerzos de abrasión medio-pesados, como casas unifamiliares y locales comerciales de tráfico ligero / Материалы рекомендованы для использования в частных домах и коммерческих помещениях, подверженных средне-сильному абразивному воздействию

PEZZI SPECIALI / TRIMS / SPEZIALTEILE / PIÈCES SPÉCIALES / PIEZAS ESPECIALES / СПЕЦИАЛЬНЫЕ ИЗДЕЛИЯ

### BT.B.C.

Battiscopa Becco Civetta ottenuto da taglio del fondo / Coved Edge Skirting Tile cut from plain tile / Sockelleiste, Halbbrundstab, aus Grundfliese geschnitten / Plinthe bord rond découpée dans le fond / Rodapié canto romo conseguido mediante corte del fondo / Плинтус с закругленным краем, полученный из фоновой плитки

### BT.B.C.\*

Battiscopa Becco Civetta ottenuto per pressatura / Press-formed Coved Edge Skirting Tile / Sockelleiste, Halbbrundstab, gepresst / Plinthe bord rond obtenue par pressage / Rodapié canto romo conseguido mediante prensado / Плинтус с закругленным краем, полученный пресованием

### E.Elle

Elemento ad Elle tagliato ed assemblato / Two-piece L-Tile / Schenkelplatte, geschnitten und zusammengesetzt / Élément en L coupé et assemblé / Elemento en forma de "L" cortado y montado / Г-образный элемент, состоящий из двух частей

CONSIGLI DI POSA / INSTALLATION ADVICE / HINWEISE ZUR VERLEGUNG / CONSEILS DE POSE / SUGERENCIAS PARA LA COLOCACIÓN / РЕКОМЕНДАЦИИ ПО УКЛАДКЕ

Per le pavimentazioni esterne non protette, Ragno consiglia di creare una pendenza  $\geq 1,5\%$  sulla superficie calpestabile allo scopo di limitare il formarsi di ristagni d'acqua localizzati. Nel caso in cui questi ristagni permangano sulla superficie delle piastrelle nonostante una posa a regola d'arte, è necessario intervenire meccanicamente con l'utilizzo di scope o aspira-liquidi / For unprotected outdoor pavings, Ragno recommends the creation of a gradient of  $\geq 1,5\%$  on the finished surface, to prevent the formation of patches of standing water. In the event that standing water persists on the surface of the tiles in spite of correct installation, it must be removed mechanically with the aid of brooms or wet-and-dry vacuum cleaners / Zur Unterbindung von punktueller Stauwasserbildung bei Belägen in ungeschützten Außenbereichen, empfiehlt die Ragno die Ausbildung eines Gefälles  $\geq 1,5\%$  auf der Trittlfläche. Sollte trotz fachgerechter Verlegung Stauwasser auf der Fliesenoberfläche zurückbleiben, ist dessen mechanische Entfernung mit Hilfe eines Besens oder Nasssaugers erforderlich / Pour des sols extérieurs non protégés, Ragno conseille de créer une inclinaison  $\geq 1,5\%$  sur la surface de piétinement en vue de limiter la stagnation localisée de l'eau. Si, malgré une pose dans les règles de l'art, cette stagnation devait persister à la surface des carreaux, une intervention mécanique, au moyen de balais et d'aspirateurs de liquides, est alors nécessaire / En el caso de pavimentaciones exteriores no protegidas, Ragno recomienda crear una pendiente  $\geq 1,5\%$  en la superficie transitable para limitar la formación de depósitos localizados de agua estancada. En caso de que estos depósitos de agua permanezcan en la superficie del azulejo, aun cuando la colocación se haya realizado correctamente, será necesario intervenir mecánicamente empleando un cepillo o un aspirador de líquidos / Для наружных незащищенных полов Ragno рекомендует создавать уклон  $\geq 1,5\%$  на пешеходной поверхности для снижения образования локальных застоев воды. В случае, если застои воды образуются на плитке несмотря на правильную укладку, необходимо прибегать к использованию механических средств, таких как щетки или же аппараты для сбора жидкостей

CARATTERISTICHE / CHARACTERISTICS / EIGENSCHAFTEN / CARACTERISTIQUES / DATOS / ХАРАКТЕРИСТИКИ

**R9** Naturale/Matt  
**R11** Strutturato  
**PENDULUM**  
**classe 1** Naturale/Matt  
**classe 3** Strutturato  
**ptv > 36** Strutturato

**B** Strutt 30x60  
**C** Strutt 33,3x33,3

CERTIFICAZIONI / CERTIFICATIONS / ZERTIFIZIERUNGEN / CERTIFICATIONS / CERTIFICACIONES / СЕРТИФИКАЦИИ



IMBALLI / PACKAGING / VERPACKUNGEN / EMBALLAGES / EMBALAJES / УПАКОВКИ

	scatole / box / karton / boîte / caja / короб			pallet / pallet / palette / palette / pallet / поддон				
	□	M²	KG	□	M²	KG	± mm	
60x60	3	1,08	22,50	40	43,20	900,00	9,5	
45x45	5	1,01	19,70	33	33,41	650,11	9	
30x60	6	1,08	23,04	48	51,84	1105,80	9,5	
30x60	Strutturato	5	0,90	19,20	48	43,20	921,60	9,5
33,3x33,3		16	1,77	29,59	38	67,42	1124,44	8
33,3x33,3	Strutturato	16	1,77	29,59	38	67,42	1124,44	8
7x60	BT.B.C.	15	9,00 ml	14,53	-	-	9,5	
8x45	BT.B.C.	30	13,50 ml	18,07	-	-	9	
8x33,3	BT.B.C.	50	16,65 ml	22,10	-	-	8	
15x33,3	E.ELLE	6	0,30	7,40	-	-	-	



# Sound



R49K Pearl 60x60 - 23<sup>5/8</sup>"x23<sup>5/8</sup>"

gres porcellanato / porcelain stoneware / feinsteinzeug / grès cérame émaillé / gres porcelánico / керамогранит

gruppo Bia UNI EN 14411\_G

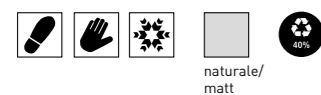

FORMATI / SIZES / FORMATE / FORMATS / FORMATOS / ФОРМАТЫ

<b>60x60 cm</b> 23 <sup>5/8</sup> "x23 <sup>5/8</sup> " ± 9 mm	<b>45x45 cm</b> 17 <sup>11/16</sup> "x17 <sup>11/16</sup> " ± 9 mm	<b>30x60 cm</b> 11 <sup>13/16</sup> "x23 <sup>5/8</sup> " ± 9 mm	<b>33,3x33,3 cm</b> 13 <sup>1/8</sup> "x13 <sup>1/8</sup> " ± 8 mm
--	--	--	--

## Off White



R49H 60x60  
R52U 45x45  
R49M 30x60  
R52K 33,3x33,3

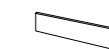

R49R 7x60 BT.B.C.  
R52Y 8x33,3 BT.B.C.  
R53T 8x45 BT.B.C.

## Cream



R49J 60x60  
R52V 45x45  
R49N 30x60  
R52L 33,3x33,3

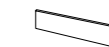

R49S 7x60 BT.B.C.  
R52Z 8x33,3 BT.B.C.  
R53U 8x45 BT.B.C.

## Pearl



R49K 60x60  
R52W 45x45  
R49P 30x60  
R52M 33,3x33,3



R49T 7x60 BT.B.C.  
R53A 8x33,3 BT.B.C.  
R53V 8x45 BT.B.C.

# Sound

## Smoke



**R49L** 60x60  
**R52X** 45x45  
**R49Q** 30x60  
**R52N** 33,3x33,3

60x60 - 23<sup>5/8</sup> x 23<sup>5/8</sup> 45x45 - 17<sup>11/16</sup> x 17<sup>11/16</sup> 30x60 - 11<sup>13/16</sup> x 23<sup>5/8</sup> 33,3x33,3 - 13<sup>1/8</sup> x 13<sup>1/8</sup>



**R49U** 7x60 BT.B.C.  
**R53C** 8x33,3 BT.B.C.  
**R53W** 8x45 BT.B.C.

## TECH INFO

DESTINAZIONE D'USO / INTENDED USE / ANWENDUNGSBEREICH /  
 CHAMP D'APPLICATION / USO PREVISTO / НАЗНАЧЕНИЕ

### G (Naturale/Matt)

Materiali consigliati per locali sottoposti a sollecitazioni all'abrasione medio pesanti come: case individuali, commerciale leggero / Materials recommended for premises with medium-heavy abrasion levels, such as: detached homes, light-traffic commercial premises / Empfohlen für Räume mit mittelschwerer Abriebbeanspruchung wie: Einfamilienhäuser, leicht beanspruchte Gewerbebereiche / Matériaux recommandés pour des locaux soumis à des contraintes d'abrasion moyennes et fortes comme : maisons particulières, espaces commerciaux soumis à un trafic léger, etc / Materiales recomendados para locales sometidos a esfuerzos de abrasión medio-pesados, como casas unifamiliares y locales comerciales de tráfico ligero / Материалы рекомендованы для использования в частных домах и коммерческих помещениях, подверженных средне-сильному абразивному воздействию

PEZZI SPECIALI / TRIMS / SPEZIALTEILE / PIÈCES SPÉCIALES /  
 PIEZAS ESPECIALES / СПЕЦИАЛЬНЫЕ ИЗДЕЛИЯ

### BT.B.C.

Battiscopa Becco Civetta ottenuto per pressatura / Press-formed Coved Edge Skirting Tile / Sockelleiste, Halbrundstab, gepresst / Plinthe bord rond obtenue par pressage / Rodapié canto romo conseguido mediante prensado / Плинтус с закругленным краем, полученный прессованием

CARATTERISTICHE / CHARACTERISTICS / EIGENSCHAFTEN /  
 CARACTERISTICAS / DATOS / ХАРАКТЕРИСТИКИ

 <b>R9</b>	<b>PENDULUM</b> classe 1	<b>BCR</b> μ > 0,40
---	-----------------------------	------------------------

CERTIFICAZIONI / CERTIFICATIONS / ZERTIFIZIERUNGEN /  
 CERTIFICACIONES / CERTIFICACIONES / СЕРТИФИКАЦИИ



IMBALLI / PACKAGING / VERPACKUNGEN / EMBALLAGES / EMBALAJES / УПАКОВКИ

	scatole / box / karton / boîte / caja / коробк			pallet / pallet / palette / palette / pallet / поддон			
		<b>M²</b>	<b>KG</b>		<b>M²</b>	<b>KG</b>	<b>± mm</b>
60x60	3	1,08	24,78	40	43,20	991,50	9
45x45	5	1,01	21,79	33	33,41	719,13	9
30x60	6	1,08	20,83	48	51,84	999,80	9
33,3x33,3	16	1,77	30,10	38	67,42	1143,95	8
7x60							8,5
	BT.B.C.	16	9,60 ml	15,53	-	-	-
8x33,3	BT.B.C.	50	16,65 ml	20,60	-	-	8
8x45	BT.B.C.	30	13,50 ml	16,53	-	-	9

SMART FLOOR

# Escape



R15V Tortora 12,5x50 - 4<sup>29/32</sup>x19<sup>11/16</sup>"

gres porcellanato / porcelain stoneware / feinsteinzeug / grès cérame émaillé / gres porcelánico / керамогранит

gruppo B1a UNI EN 14411\_G



FORMATI / SIZES / FORMATE / FORMATS / FORMATOS / ФОРМАТЫ

12,5x50 cm

4<sup>15/16</sup>"x19<sup>11/16</sup>"

± 8,5 mm

12,5x50 - 4<sup>15/16</sup>"x19<sup>11/16</sup>"

Avorio



R15T 12,5x50

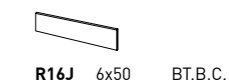

Miele



R15U 12,5x50  
R17F 12,5x50 Grip

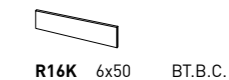

Tortora



R15V 12,5x50

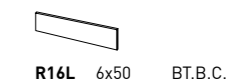

# Escape

## Marrone



**R15W** 12,5x50  
**R17G** 12,5x50 Grip

12,5x50 - 4<sup>15/16</sup>"x19<sup>1/16</sup>"



**R16M** 6x50 BT.B.C.

## TECH INFO

VARIAZIONI CROMATICHE / COLOUR VARIATIONS / FARBVARIATIONEN / VARIATIONS CHROMATIQUES / VARIACIONES CROMÁTICAS / ВАРИАНТЫ ОТТЕЧКА



**V2**

Apprezzabili differenze nell'aspetto di superficie e grafica all'interno della stessa produzione / Clearly distinguishable differences in texture and pattern within the same production run / Auffällige Unterschiede in Aussehen und Struktur innerhalb der gleichen Produktionscharge / Différences visibles au niveau de l'aspect et de la fantaisie entre les carreaux du même lot de production / Diferencias visibles en el aspecto de la superficie y los motivos dentro de un mismo lote de producción / заметные отличия вида поверхности и графики в одной и той же партии

DESTINAZIONE D'USO / INTENDED USE / ANWENDUNGSBEREICH / CHAMP D'APPLICATION / USO PREVISTO / НАЗНАЧЕНИЕ

**G (Avorio, Miele, Tortora, Marrone, Grigio: Naturale/Matt Miele: Grip)**

Materiali consigliati per locali sottoposti a sollecitazioni all'abrasione medio pesanti come: case individuali, commerciale leggero / Materials recommended for premises with medium-heavy abrasion levels, such as: detached homes, light-traffic commercial premises / Empfohlen für Räume mit mittelschwerer Abriebbeanspruchung wie: Einfamilienhäuser, leicht beanspruchte Gewerbebereiche / Matériaux recommandés pour des locaux soumis à des contraintes d'abrasion moyennes et fortes comme : maisons particulières, espaces commerciaux soumis à un trafic léger, etc / Materiales recomendados para locales sometidos a esfuerzos de abrasión medio-pesados, como casas unifamiliares y locales comerciales de tráfico ligero / Материалы рекомендованы для использования в частных домах и коммерческих помещениях, подверженных средне-сильному абразивному воздействию

## H (Marrone: Grip)

Materiali consigliati per sollecitazioni all'abrasione relativamente forti in ambienti anche non protetti da agenti graffianti / Materials recommended for relatively heavy abrasion levels, also in premises not protected against abrasive substances / Materials recommended for relatively heavy abrasion levels, also in premises not protected against abrasive substances / Empfohlen für starke Abriebbeanspruchungen in Bereichen auch ohne Kratzschutzbehandlung / Matériaux recommandés pour des locaux soumis à des fortes contraintes d'abrasion, même non protégés contre les agents abrasifs / Materiales recomendados para soportar esfuerzos de abrasión relativamente intensos incluso en espacios no protegidos frente a agentes abrasivos / Материалы рекомендованы для относительно сильного абразивного воздействия, в том числе в помещениях, не защищенных от царапающих элементов

PEZZI SPECIALI / TRIMS / SPEZIALTEILE / PIÈCES SPÉCIALES / PIEZAS ESPECIALES / СПЕЦИАЛЬНЫЕ ИЗДЕЛИЯ

## BT.B.C.

Battiscopa Becco Civetta ottenuto da taglio del fondo / Coved Edge Skirting Tile cut from plain tile / Sockelleiste, Halbrundstab, aus Grundfliese geschnitten / Plinthe bord rond découpée dans le fond / Rodapié canto romo conseguido mediante corte del fondo / Плинтус с закругленным краем, полученный из фоновой плитки

## Grigio



**R15X** 12,5x50



**R16N** 6x50 BT.B.C.

## Decors



**R17N** 12,5x50 Decoro Antique Miele

Abbinabile ai colori / Matching with colours / Mit den Grundfliesen kombinierbar / Peut s'associer aux carreaux de base de couleurs / Puede combinarse con los fondos / Сочетается с фоновой плиткой



**Miele** **Marrone**





**R17P** 12,5x50 Decoro Antique Grigio

Abbinabile ai colori / Matching with colours / Mit den Grundfliesen kombinierbar / Peut s'associer aux carreaux de base de couleurs / Puede combinarse con los fondos / Сочетается с фоновой плиткой



**Grigio** **Tortora**

CARATTERISTICHE / CHARACTERISTICS / EIGENSCHAFTEN / CARACTERISTIQUES / DATOS / ХАРАКТЕРИСТИКИ

 <b>R9</b> Naturale/Matt	<b>PENDULUM</b> classe 3 Grip ptv > 36 Grip	<b>D-COF</b> > 0,42 Grip	<b>BCR</b> μ > 0,40 Grip
 <b>R11</b> Grip			
 <b>C</b> Grip			

CERTIFICAZIONI / CERTIFICATIONS / ZERTIFIZIERUNGEN / CERTIFICACIONES / СЕРТИФИКАЦИИ



IMBALLI / PACKAGING / VERPACKUNGEN / EMBALAJES / УПАКОВКИ

		scatole / box / karton / boîte / caja / коробк			pallet / pallet / palette / palette / pallet / поддон			
		□	m²	KG	□	m²	KG	± mm
12,5x50		16	1,00	17,00	72	72,00	1224,00	8,5
12,5x50	Grip	16	1,00	17,00	72	72,00	1224,00	8,5
12,5x50	Decoro	16	1,00	17,00	72	72,00	1224,00	8,5
6x50	BT.B.C.	15	7,50 ml	9,37	-	-	-	8,5

SMART FLOOR

# Freetime



R44Y Rovere 12,5x50 - 4<sup>29/32</sup>"x19<sup>11/16</sup>"

gres porcellanato / porcelain stoneware / feinsteinzeug / grès cérame émaillé / gres porcelánico / керамогранит

gruppo Bia UNI EN 14411\_G

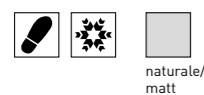

FORMATI / SIZES / FORMATE / FORMATS / FORMATOS / ФОРМАТЫ

12,5x50 cm

4<sup>15/16</sup>"x19<sup>11/16</sup>"

± 8,5 mm

12,5x50 - 4<sup>15/16</sup>"x19<sup>11/16</sup>"

Avorio



R44W 12,5x50



Miele



R44X 12,5x50

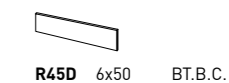

Rovere



R44Y 12,5x50



# Freetime

## Marrone



R45A 12,5x50

12,5x50 - 4<sup>15/16</sup>"x19<sup>11/16</sup>"



R45G 6x50 BT.B.C.

## Fumo



R44Z 12,5x50



R45F 6x50 BT.B.C.

## TECH INFO

DESTINAZIONE D'USO / INTENDED USE / ANWENDUNGSBEREICH / CHAMP D'APPLICATION / USO PREVISTO / НАЗНАЧЕНИЕ

### G (Naturale/Matt)

Materiali consigliati per locali sottoposti a sollecitazioni all'abrasione medio pesanti come: case individuali, commerciale leggero / Materials recommended for premises with medium-heavy abrasion levels, such as: detached homes, light-traffic commercial premises / Empfohlen für Räume mit mittelschwerer Abriebbeanspruchung wie: Einfamilienhäuser, leicht beanspruchte Gewerbebereiche / Matériaux recommandés pour des locaux soumis à des contraintes d'abrasion moyennes et fortes comme : maisons particulières, espaces commerciaux soumis à un trafic léger, etc / Materiales recomendados para locales sometidos a esfuerzos de abrasión medio-pesados, como casas unifamiliares y locales comerciales de tráfico ligero / Материалы рекомендованы для использования в частных домах и коммерческих помещениях, подверженных средне-сильному абразивному воздействию

PEZZI SPECIALI / TRIMS / SPEZIALTEILE / PIÈCES SPÉCIALES / PIEZAS ESPECIALES / СПЕЦИАЛЬНЫЕ ИЗДЕЛИЯ

### BT.B.C.

Battiscopa Becco Civetta ottenuto da taglio del fondo / Coved Edge Skirting Tile cut from plain tile / Sockelleiste, Halbrundstab, aus Grundfliese geschnitten / Plinthe bord rond découpée dans le fond / Rodapié canto romo conseguido mediante corte del fondo / Плинтус с закругленным краем, полученный из фоновой плитки

CARATTERISTICHE / CHARACTERISTICS / EIGENSCHAFTEN / CARACTERISTIQUES / DATOS / ХАРАКТЕРИСТИКИ



R9

PENDULUM  
classe 1

CERTIFICAZIONI / CERTIFICATIONS / ZERTIFIZIERUNGEN / CERTIFICACIONES / СЕРТИФИКАЦИИ



IMBALLI / PACKAGING / VERPACKUNGEN / EMBALLAGES / EMBALAJES / УПАКОВКИ

	scatole / box / karton / boîte / caja / коробк			pallet / pallet / palette / palette / pallet / поддон			
	□	M²	KG	□	M²	KG	± mm
12,5x50	16	1,00	17,00	72	72,00	1224,00	8,5
6x50	BT.B.C.	15	7,50 ml	9,00	-	-	8,5

# Emilia

30x30 - 11<sup>13/16</sup>"x11<sup>13/16</sup>" 15x15 - 5<sup>7/8</sup>"x5<sup>7/8</sup>"



RL14 Grey 30x30 - 11<sup>13/16</sup>"x11<sup>13/16</sup>"

gres porcellanato / porcelain stoneware / feinsteinzeug / grès cérame émaillé / gres porcelánico / керамогранит

gruppo Bia UNI EN 14411\_G

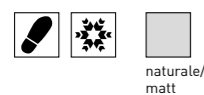

FORMATI / SIZES / FORMATE / FORMATS / FORMATOS / ФОРМАТЫ

<b>30x30 cm</b> 11 <sup>13/16</sup> "x11 <sup>13/16</sup> " ± 9 mm	<b>15x15 cm</b> 5 <sup>7/8</sup> "x5 <sup>7/8</sup> " ± 9 mm
--	--

BI

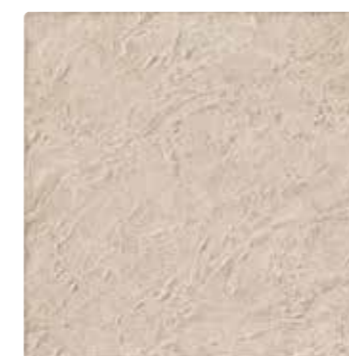

**4X74** 30x30  
**4X09** 15x15

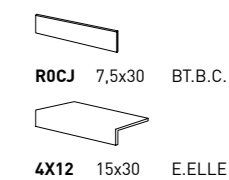

BG



**R5L3** 30x30  
**OL38** 15x15

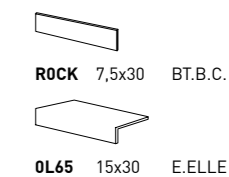

RO



**R5L2** 30x30  
**OL37** 15x15

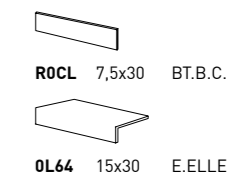

# Emilia

30x30 - 11<sup>13/16</sup>"x11<sup>13/16</sup>" 15x15 - 5<sup>7/8</sup>"x5<sup>7/8</sup>"

SA



4X75 30x30  
4X10 15x15



R4LR 7,5x30 BT.B.C.

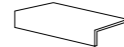

4X13 15x30 E.ELLE

## TECH INFO

DESTINAZIONE D'USO / INTENDED USE / ANWENDUNGSBEREICH /  
CHAMP D'APPLICATION / USO PREVISTO / НАЗНАЧЕНИЕ

### H (Naturale/Matt)

Materiali consigliati per sollecitazioni all'abrasione relativamente forti in ambienti anche non protetti da agenti graffianti / Materials recommended for relatively heavy abrasion levels, also in premises not protected against abrasive substances / Materials recommended for relatively heavy abrasion levels, also in premises not protected against abrasive substances / Empfohlen für starke Abriebbeanspruchungen in Bereichen auch ohne Kratzschutzbehandlung / Matériaux recommandés pour des locaux soumis à des fortes contraintes d'abrasion, même non protégés contre les agents abrasifs / Materiales recomendados para soportar esfuerzos de abrasión relativamente intensos incluso en espacios no protegidos frente a agentes abrasivos / Материалы рекомендованы для относительно сильного абразивного воздействия, в том числе в помещениях, не защищенных от царапающих элементов

PEZZI SPECIALI / TRIMS / SPEZIALTEILE / PIÈCES SPÉCIALES /  
PIEZAS ESPECIALES / СПЕЦИАЛЬНЫЕ ИЗДЕЛИЯ

### BT.B.C.

Battiscopa Becco Civetta ottenuto per pressatura / Press-formed Coved Edge Skirting Tile / Sockelleiste, Halbrundstab, gepresst / Plinthe bord rond obtenue par pressage / Rodapié canto romo conseguido mediante prensado / Плинтус с закругленным краем, полученный прессованием

### E.Elle

Elemento ad Elle monolitico / One-piece L-Tile / Schenkelplatte, einteilig / Élément en L monolithique / Elemento en forma de "L" monolítico / Монолитный Г-образный элемент

CT



4X77 30x30  
0L40 15x15



R0CP 7,5x30 BT.B.C.



0L67 15x30 E.ELLE

GR



RL14 30x30  
0L36 15x15



R0CQ 7,5x30 BT.B.C.



0L63 15x30 E.ELLE

CARATTERISTICHE / CHARACTERISTICS / EIGENSCHAFTEN /  
CARACTERISTIQUES / DATOS / ХАРАКТЕРИСТИКИ

R9	PENDULUM classe 1	BCR μ > 0,40
----	----------------------	-----------------

CERTIFICAZIONI / CERTIFICATIONS / ZERTIFIZIERUNGEN /  
CERTIFICACIONES / СЕРТИФИКАЦИИ



IMBALLI / PACKAGING / VERPACKUNGEN / EMBALLAGES / EMBALAJES / УПАКОВКИ

	scatole / box / karton / boîte / caja / коробк			pallet / pallet / palette / palette / pallet / поддон			
	□	M²	KG	□	M²	KG	± mm
30x30	14	1,26	25,12	40	50,40	1004,99	9
15x15	40	0,90	15,25	64	57,60	976,27	9
7,5x30	BT.B.C.	50	15,00 ml	20,05	-	-	8
15x30	E.ELLE	6	0,27	5,70	-	-	-



# Galassia

30x30 - 11<sup>13/16</sup>"x11<sup>13/16</sup>" 20x20 - 7<sup>7/8</sup>"x7<sup>7/8</sup>"



4M45 Fumo 30x30 - 11<sup>13/16</sup>"x11<sup>13/16</sup>"

gres porcellanato / porcelain stoneware / feinsteinezeug / grès cérame émaillé / gres porcelánico / керамогранит

gruppo Bia UNI EN 14411\_G

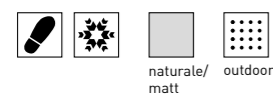

naturale/  
matt outdoor

FORMATI / SIZES / FORMATE / FORMATS / FORMATOS / ФОРМАТЫ

30x30 cm  
11<sup>13/16</sup>"x11<sup>13/16</sup>"  
± 8,5 mm

20x20 cm  
7<sup>7/8</sup>"x7<sup>7/8</sup>"  
± 8 mm - 14 mm

## Panna

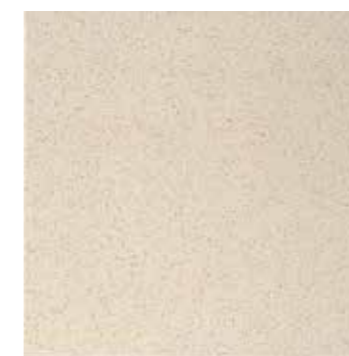

4M41 30x30  
4M28 20x20  
R9Z5 20x20 ± 14 mm



R0WG 9,5x30 BT.B.C.  
RA98 10x20 BT.B.C.\*

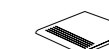

8E46 30x30 SC.B.C.

## Canapa New



R0UT 30x30



R0WL 9,5x30 BT.B.C.



R0YD 30x30 SC.B.C.

## Fumo

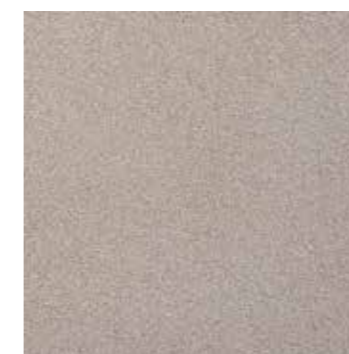

4M45 30x30  
4M32 20x20

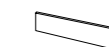

R0WJ 9,5x30 BT.B.C.



7C43 30x30 SC.B.C.

# Galassia

## Antracite New

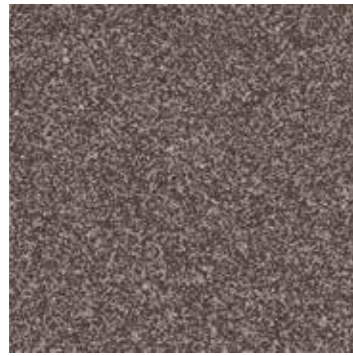

ROUR 30x30

## Panna Rock



ROVJ 20x20

30x30 - 11<sup>13/16</sup>" x 11<sup>13/16</sup>" 20x20 - 7<sup>7/8</sup>" x 7<sup>7/8</sup>"



ROWH 9,5x30 BT.B.C.

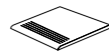

ROYA 30x30 SC.B.C.

## TECH INFO

DESTINAZIONE D'USO / INTENDED USE / ANWENDUNGSBEREICH / CHAMP D'APPLICATION / USO PREVISTO / НАЗНАЧЕНИЕ

### H (Naturale/Matt, Strutturato)

Materiali consigliati per sollecitazioni all'abrasione relativamente forti in ambienti anche non protetti da agenti graffianti / Materials recommended for relatively heavy abrasion levels, also in premises not protected against abrasive substances / Materials recommended for relatively heavy abrasion levels, also in premises not protected against abrasive substances / Empfohlen für starke Abriebbeanspruchungen in Bereichen auch ohne Kratzschutzbehandlung / Matériaux recommandés pour des locaux soumis à des fortes contraintes d'abrasion, même non protégés contre les agents abrasifs / Materiales recomendados para soportar esfuerzos de abrasión relativamente intensos incluso en espacios no protegidos frente a agentes abrasivos / Материалы рекомендованы для относительно сильного абразивного воздействия, в том числе в помещениях, не защищенных от царапающих элементов

PEZZI SPECIALI / TRIMS / SPEZIALTEILE / PIÈCES SPÉCIALES / PIEZAS ESPECIALES / СПЕЦИАЛЬНЫЕ ИЗДЕЛИЯ

### BT.B.C.

Battiscopa Becco Civetta ottenuto da taglio del fondo / Coved Edge Skirting Tile cut from plain tile / Sockelleiste, Halbrundstab, aus Grundfliese geschnitten / Plinthe bord rond découpée dans le fond / Rodapié canto romo conseguido mediante corte del fondo / Плинтус с закругленным краем, полученный из фоновой плитки

### BT.B.C.\*, BT.FRANCESE\*, BT.SGU.\*

Battiscopa ottenuto per pressatura / Pressed skirting tile / Gepresster Sockel / Plinthe obtenue par pressage / Rodapié obtenido mediante prensado / Плинтус, полученный в результате прессовки

### SC.B.C.



Scalino Becco Civetta con righe in corindone / Coved step tile with carborundum strips / Treppenauftritt mit Halbrundstab und aufgesetzten Korundprofilen / Marche à bord rond avec bandes en corindon / Escalón de canto romo con rayas de corindón / Ступень с закругленным краем с полосками из корунда

CONSIGLI DI POSA / INSTALLATION ADVICE / HINWEISE ZUR VERLEGUNG / CONSEILS DE POSE / SUGERENCIAS PARA LA COLOCACIÓN / РЕКОМЕНДАЦИИ ПО УКЛАДКЕ

Per le pavimentazioni esterne non protette, Ragno consiglia di creare una pendenza  $\geq 1,5\%$  sulla superficie calpestabile allo scopo di limitare il formarsi di ristagni d'acqua localizzati. Nel caso in cui questi ristagni permangano sulla superficie delle piastrelle nonostante una posa a regola d'arte, è necessario intervenire meccanicamente con l'utilizzo di scope o aspira-liquidi / For unprotected outdoor pavings, Ragno recommends the creation of a gradient of  $\geq 1,5\%$  on the finished surface, to prevent the formation of patches of standing water. In the event that standing water persists on the surface of the tiles in spite of correct installation, it must be removed mechanically with the aid of brooms or wet-and-dry vacuum cleaners / Zur Unterbindung von punktueller Stauwasserbildung bei Belägen in ungeschützten Außenbereichen, empfiehlt die Ragno die Ausbildung eines Gefälles  $\geq 1,5\%$  auf der Trittlfläche. Sollte trotz fachgerechter Verlegung Stauwasser auf der Fliesenoberfläche zurückbleiben, ist dessen mechanische Entfernung mit Hilfe eines Besens oder Nasssaugers erforderlich / Pour des sols extérieurs non protégés, Ragno conseille de créer une inclinaison  $\geq 1,5\%$  sur la surface de piétinement en vue de limiter la stagnation localisée de l'eau. Si, malgré une pose dans les règles de l'art, cette stagnation devait persister à la surface des carreaux, une intervention mécanique, au moyen de balais et d'aspirateurs de liquides, est alors nécessaire / En el caso de pavimentaciones exteriores no protegidas, Ragno recomienda crear una pendiente  $\geq 1,5\%$  en la superficie transitabile para limitar la formación de depósitos localizados de agua estancada. En caso de que estos depósitos de agua permanezcan en la superficie del azulejo, aun cuando la colocación se haya realizado correctamente, será necesario intervenir mecánicamente empleando un cepillo o un aspirador de líquidos / Для наружных незащищенных полов Ragno рекомендует создавать уклон  $\geq 1,5\%$  на пешеходной поверхности для снижения образования локальных застоев воды. В случае, если застои воды образуются на плитке несмотря на правильную укладку, необходимо прибегать к использованию механических средств, таких как щетки или же аппараты для сбора жидкостей



CARATTERISTICHE / CHARACTERISTICS / EIGENSCHAFTEN / CARACTERISTIQUES / DATOS / ХАРАКТЕРИСТИКИ







CERTIFICAZIONI / CERTIFICATIONS / ZERTIFIZIERUNGEN / CERTIFICATIONS / CERTIFICACIONES / СЕРТИФИКАЦИИ

 <b>R9</b> <b>R12</b> Rock	<b>PENDULUM</b> <b>classe 1</b> <b>classe 2</b> Rock <b>ptv &gt; 36</b> Rock	<b>BCR</b> <b><math>\mu &gt; 0,40</math></b>
 <b>B</b> Rock		
 <b>≤ 175 mm<sup>2</sup></b>		



IMBALLI / PACKAGING / VERPACKUNGEN / EMBALLAGES / EMBALAJES / УПАКОВКИ

	scatole / box / karton / boîte / caja / коробк			pallet / pallet / palette / palette / pallet / поддон			
		<b>M<sup>2</sup></b>	<b>KG</b>		<b>M<sup>2</sup></b>	<b>KG</b>	<b>± mm</b>
30x30	15	1,35	24,00	40	54,00	959,96	8,5
20x20	30	1,20	21,10	54	64,80	1139,68	8
20x20	<b>± 14 mm</b>	17	0,68	54	36,72	1160,20	14
20x20	<b>Rock</b>	30	1,20	54	64,80	1113,86	8
9,5x30	BT.B.C.	30	9,00 ml	-	-	-	8,5
10x20	BT.	25	5,00 ml	-	-	-	8
30x30	SC.B.C.	15	1,35	-	-	-	-
3x10	AN. / SP.	10	0,03	-	-	-	-
3x20	CN.	10	0,06	-	-	-	-

							
<b>Panna</b>	<b>ROWR</b>	<b>ROWT</b>	<b>ROWX</b>	<b>ROXQ</b>	<b>ROXS</b>	<b>ROXW</b>	<b>ROXC</b>
<b>Fumo</b>	<b>4T64</b>	<b>ROWU</b>	<b>ROWY</b>	<b>4P22</b>	<b>ROXT</b>	<b>ROXX</b>	<b>ROXD</b>

# Unitech



R10A Topazio R10 B 20x20 - 7<sup>7/8</sup>"x7<sup>7/8</sup>"

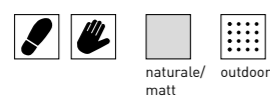

FORMATI / SIZES / FORMATE / FORMATS / FORMATOS / ФОРМАТЫ

<b>20x20 cm</b> 7 <sup>7/8</sup> "x7 <sup>7/8</sup> " ± 7,2 mm - 8mm	<b>10x30 cm</b> 3 <sup>15/16</sup> "x1 <sup>13/16</sup> " ± 7,5 mm	<b>10x10 cm</b> 3 <sup>15/16</sup> "x3 <sup>15/16</sup> " ± 7 mm
--	--	--

SMART WALL  
Unitech Wall > p.676

20x20 - 7<sup>7/8</sup>"x7<sup>7/8</sup>" 10x30 - 3<sup>15/16</sup>"x1<sup>13/16</sup>" 10x10 - 3<sup>15/16</sup>"x3<sup>15/16</sup>"

## Bianco

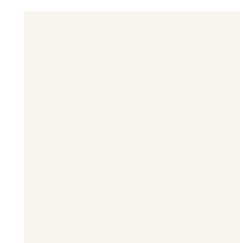

RN46 20x20  
R1PG 20x20 R9  
R1PY 20x20 Grip R10 B  
R1UT 10x30  
94D9 10x10  
94F1 10x10 PC  
94G4 10x10 Grip R12  
94H0 10x10 Grip R12 PC

## Argento



R1NL 20x20  
R1PS 20x20 R9  
R1UU 10x30  
R1QH 10x10

## Nero



RN51 20x20  
R1UV 10x30  
94E2 10x10

## Crema



R1NM 20x20

## Cristallo



R1NO 20x20

## Cenere



RN50 20x20  
R1PW 20x20 R9

## Beige



R1NJ 20x20  
R1UW 10x30

## Incenso



R1NZ 20x20  
R1UX 10x30

# Unitech

20x20 - 7/8" x 7/8" 10x30 - 3 15/16" x 1 13/16" 10x10 - 3 15/16" x 3 15/16"

## Lime



R1NN 20x20  
R1UZ 10x30

## Menta



R1NT 20x20

## Rubino



R1NY 20x20  
R1VC 10x30

## Smeraldo



R1NW 20x20

## Turchese



R1NX 20x20  
R1V0 10x30

## Topazio

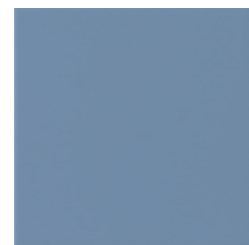

R1NV 20x20  
R1QA 20x20 Grip R10 B

## Oceano



R1NR 20x20  
R1VA 10x30

## Giallo



R1NQ 20x20  
R1VB 10x30

## Arancio



R1NK 20x20

Bianco	98B9	8523	8527	R1RD	R1RS	R1RS	8515	R1RU
Cenere	98B8							
Topazio	R1RH							

### CARATTERISTICHE / CHARACTERISTICS / EIGENSCHAFTEN / CARACTERISTIQUES / DATOS / ХАРАКТЕРИСТИКИ

	R9 20x20	<b>PENDULUM</b>
	R10 20x20 Grip	<b>classe 1</b> 10x10 Pav/Riv Blla
	R12 10x10 Grip	20x20 Grip R10 B Pav Blb
		R9 Pav Blb
		<b>classe 3</b> 10x10 Grip Pav Blla
	B 20x20 Grip	

### IMBALLI / PACKAGING / VERPACKUNGEN / EMBALLAGES / EMBALAJES / УПАКОВКИ

		scatole / box / karton / boîte / caja / короб			pallet / pallet / palette / palette / pallet / поддон				
		□	M²	KG	☐	M²	KG	+ mm	gruppo EN
20x20		35	1,40	17,90	75	105,00	1342,00	7,2	BIII EN14411_L
20x20	R9	30	1,20	20,28	54	64,80	1095,15	8	BIIb EN14411_H
20x20	Grip R10 B	30	1,20	20,28	54	64,80	1095,15	8	BIIb EN14411_H
10x30		36	1,08	16,87	66	71,28	1113,58	7,5	BIIb EN14411_K
10x10		100	1,00	12,10	72	72,00	871,25	7	BIIa EN14411_J
10x10	PC	96	1,00	12,96	66	66,02	855,64	7	BIIa EN14411_J
10x10	Grip R12	100	1,00	12,10	72	72,00	871,25	7	BIIa EN14411_J
10x10	Grip R12 PC	96	1,00	12,96	66	66,02	855,64	7	BIIa EN14411_J
10x20	BTS.	25	-	9,87				7,5	BIII EN14411_L
3x20	CNE.	10	0,06 ml	0,90				-	BIII EN14411_L
3x20	CNI.	10	0,06 ml	0,90				-	BIII EN14411_L
3x10	AE.	10	0,03 ml	14,00				-	BIII EN14411_L
3x10	Al.	10	0,03 ml	14,00				-	BIII EN14411_L
3x3	Pl.	10	0,01 ml	0,10				-	BIII EN14411_L
3x3	Ul.	10	0,01 ml	0,10				-	BIII EN14411_L
3x3	Ue.	10	0,01 ml	0,10				-	BIII EN14411_L

# SMART WALL



- 632 Candy
- 636 Creek Wall
- 644 Grace
- 648 Land
- 652 Replace Wall
- 660 Casablanca Wall
- 664 Craft
- 668 Energy
- 672 Feel
- 676 Unitech Wall

SMART WALL

# Candy

20x50 - 7<sup>7/8</sup>"x19<sup>1/16</sup>"



R15R Mostarda 20x50 - 7<sup>7/8</sup>"x19<sup>1/16</sup>" - RG4P Struttura 3D Brezza Mostarda 20x50 - 7<sup>7/8</sup>"x19<sup>1/16</sup>"

rivestimenti in pasta bianca / white body wall tiles / wandfliesen aus weissen ton scherben / revetements en pate blanche / revestimientos en pasta blanca / облицовка из белой глины  
 gruppo BIII UNI EN 14411\_L

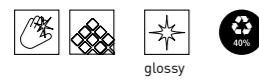

FORMATI / SIZES / FORMATE / FORMATS / FORMATOS / ФОРМАТЫ

20x50 cm  
 7<sup>7/8</sup>"x19<sup>1/16</sup>"  
 ± 8,5 mm

Puro

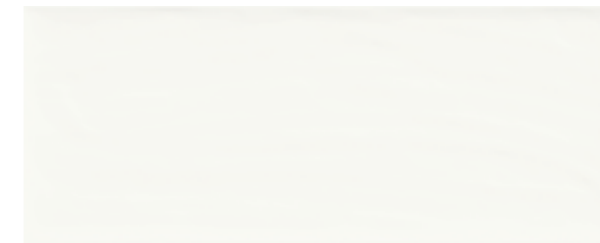

R15P 20x50

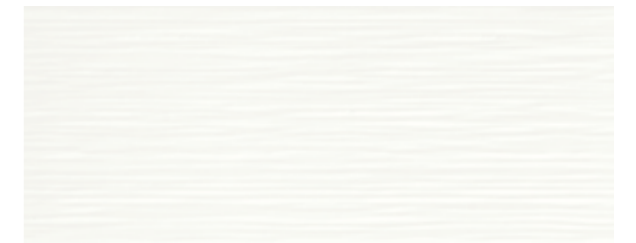

RG4M 20x50 Struttura Brezza 3D

Cenere

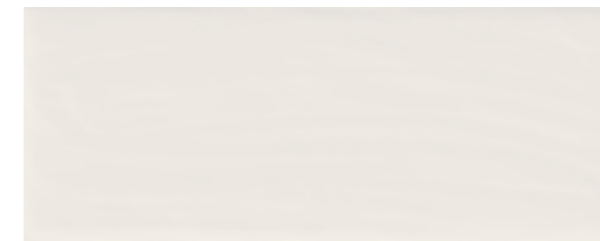

R15N 20x50



RG4N 20x50 Struttura Brezza 3D

Oceano



R15M 20x50



RG4R 20x50 Struttura Brezza 3D

Oltremare



R15L 20x50



RG4L 20x50 Struttura Brezza 3D

# Candy

20x50 - 7/8" x 1 9/16"

## Ecrù

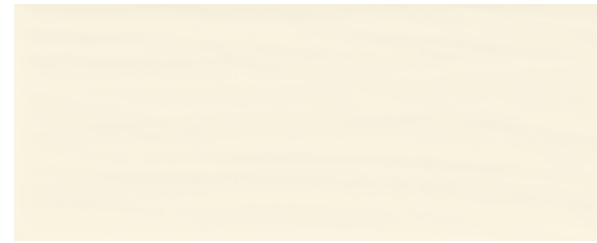

**R15Q** 20x50



**RG4K** 20x50 Struttura Brezza 3D

## Mostarda



**R15R** 20x50



**RG4P** 20x50 Struttura Brezza 3D

## Granata



**R15S** 20x50



**RG4Q** 20x50 Struttura Brezza 3D

## Decors



**R66U** 20x50 Decoro Motivo Ecrù

Abbinabile ai colori / Matching with colours / Mit den Grundfliesen kombinierbar / Peut s'associer aux carreaux de base de couleurs / Puede combinarse con los fondos / Сочетается с фоновой плиткой

**Ecrù Mostarda Oltremare**



**R189** 20x50 Decoro Motivo Puro

Abbinabile ai colori / Matching with colours / Mit den Grundfliesen kombinierbar / Peut s'associer aux carreaux de base de couleurs / Puede combinarse con los fondos / Сочетается с фоновой плиткой

**Puro Oceano Oltremare**



**RF6H** 20x50 Decoro Riviera Granata

Abbinabile ai colori / Matching with colours / Mit den Grundfliesen kombinierbar / Peut s'associer aux carreaux de base de couleurs / Puede combinarse con los fondos / Сочетается с фоновой плиткой

**Puro Granata**



**RF6G** 20x50 Decoro Riviera Ecrù

Abbinabile ai colori / Matching with colours / Mit den Grundfliesen kombinierbar / Peut s'associer aux carreaux de base de couleurs / Puede combinarse con los fondos / Сочетается с фоновой плиткой

**Puro Ecrù Mostarda**



**RF6F** 20x50 Decoro Riviera Oceano

Abbinabile ai colori / Matching with colours / Mit den Grundfliesen kombinierbar / Peut s'associer aux carreaux de base de couleurs / Puede combinarse con los fondos / Сочетается с фоновой плиткой

**Puro Oceano Oltremare**

### IMBALLI / PACKAGING / VERPACKUNGEN / EMBALLAGES / EMBALAJES / УПАКОВКИ

	scatole / box / karton / boîte / caja / коробк			pallet / pallet / palette / palette / pallet / поддон				
	□	M²	KG	□	M²	KG	± mm	
20x50	14	1,40	21,05	48	67,20	1010,47	8,5	
20x50	Struttura Brezza 3D	14	1,40	21,05	48	67,20	1010,47	8,5
20x50	Decoro Motivo	14	1,40	21,05	48	67,20	1010,47	8,5
20x50	Decoro Riviera	4	6,40	6,11	-	-	-	8,5

SMART WALL

# Creek Wall

25x76 - 9<sup>13</sup>/<sub>16</sub>"x29<sup>15</sup>/<sub>16</sub>" 20x50 - 7<sup>7</sup>/<sub>8</sub>"x19<sup>11</sup>/<sub>16</sub>"



R3RG Creek Wall Grigio 20x50 - 7<sup>7</sup>/<sub>8</sub>"x19<sup>11</sup>/<sub>16</sub>" - R3RL Creek Wall Bianco Struttura Vento 3D 20x50 - 7<sup>7</sup>/<sub>8</sub>"x19<sup>11</sup>/<sub>16</sub>" - R06Q Woodglam Tortora 10x70 - 3<sup>15</sup>/<sub>16</sub>"x27<sup>9</sup>/<sub>16</sub>"

rivestimenti in pasta bianca / white body wall tiles / wandfliesen aus weissen ton scherben / revetements en pate blanche / revestimientos en pasta blanca / облицовка из белой глины

gruppo VIII UNI EN 14411\_L

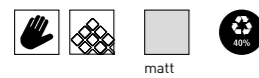

FORMATI / SIZES / FORMATE / FORMATS / FORMATOS / ФОРМАТЫ

25x76 cm  
9<sup>13</sup>/<sub>16</sub>"x29<sup>15</sup>/<sub>16</sub>"  
± 10 mm

20x50 cm  
7<sup>7</sup>/<sub>8</sub>"x19<sup>11</sup>/<sub>16</sub>"  
± 8,5 mm

SMART FLOOR  
Creek > p.590

Bianco



R9DA 25x76

Avorio



R9DE 25x76

Beige



R9DJ 25x76

Grigio

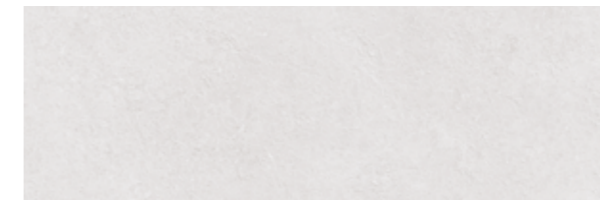

R9DG 25x76



# Creek Wall

25x76 - 9<sup>13/16</sup> x 29<sup>15/16</sup> 20x50 - 7<sup>7/8</sup> x 19<sup>11/16</sup>

## Decors



**R9DP** 25x76 Struttura Carving 3D Bianco

Abbinabile ai colori / Matching with colours / Mit den Grundfliesen kombinierbar / Peut s'associer aux carreaux de base de couleurs / Puede combinarse con los fondos / Сочетается с фоновой плиткой



**Bianco** **Grigio**

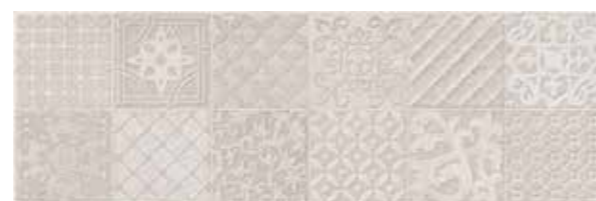

**R9DR** 25x76 Struttura Carving 3D Avorio

Abbinabile ai colori / Matching with colours / Mit den Grundfliesen kombinierbar / Peut s'associer aux carreaux de base de couleurs / Puede combinarse con los fondos / Сочетается с фоновой плиткой



**Avorio** **Beige**



**R9DL** 25x76 Decoro Fresco Bianco

Abbinabile ai colori / Matching with colours / Mit den Grundfliesen kombinierbar / Peut s'associer aux carreaux de base de couleurs / Puede combinarse con los fondos / Сочетается с фоновой плиткой



**Bianco** **Grigio**



**R9DM** 25x76 Decoro Fresco Avorio

Abbinabile ai colori / Matching with colours / Mit den Grundfliesen kombinierbar / Peut s'associer aux carreaux de base de couleurs / Puede combinarse con los fondos / Сочетается с фоновой плиткой



**Avorio** **Beige**

## Bianco

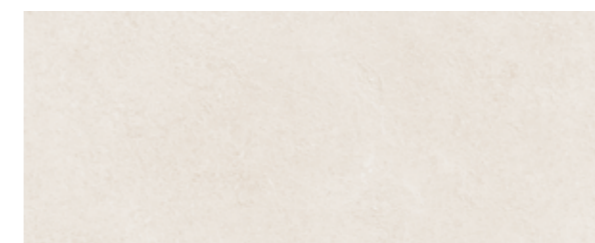

**R3RE** 20x50



**R3RL** 20x50 Struttura Vento 3D

## Avorio

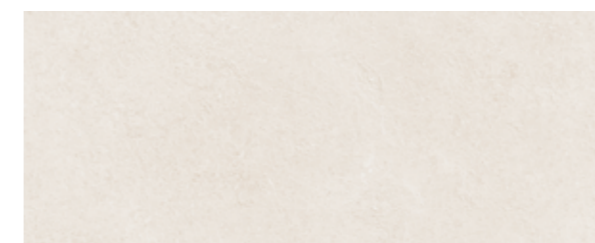

**R3RF** 20x50



**R3WE** 20x50 Struttura Vento 3D

## Beige

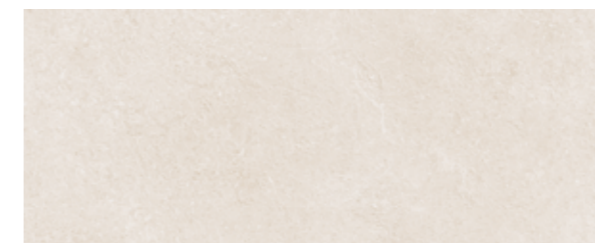

**R3RH** 20x50



**R3WF** 20x50 Struttura Vento 3D



**R3RJ** 20x50 Mosaico Beige

Abbinabile ai colori / Matching with colours / Mit den Grundfliesen kombinierbar / Peut s'associer aux carreaux de base de couleurs / Puede combinarse con los fondos / Сочетается с фоновой плиткой



**Avorio** **Beige**

# Creek Wall

25x76 - 9<sup>13/16</sup> x 29<sup>15/16</sup> 20x50 - 7<sup>7/8</sup> x 19<sup>11/16</sup>

## Grigio

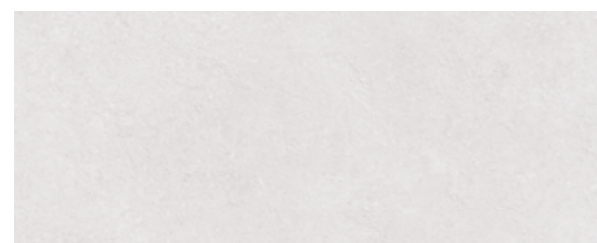

R3RG 20x50



R3RM 20x50 Struttura Vento 3D

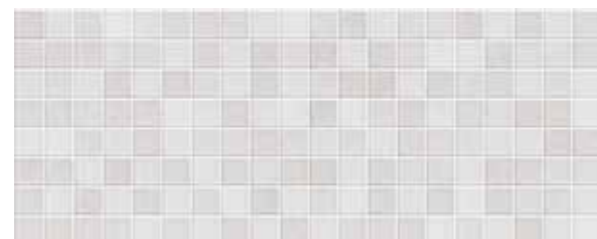

R3RK 20x50 Mosaico Grigio

Abbinabile ai colori / Matching with colours / Mit den Grundfliesen kombinierbar / Peut s'associer aux carreaux de base de couleurs / Puede combinarse con los fondos / Сочетается с фоновой плиткой



Bianco Grigio

## Decors



R5HW 20x50 Decoro Accordi Bianco

Abbinabile ai colori / Matching with colours / Mit den Grundfliesen kombinierbar / Peut s'associer aux carreaux de base de couleurs / Puede combinarse con los fondos / Сочетается с фоновой плиткой



Bianco Grigio



R5HX 20x50 Decoro Accordi Avorio

Abbinabile ai colori / Matching with colours / Mit den Grundfliesen kombinierbar / Peut s'associer aux carreaux de base de couleurs / Puede combinarse con los fondos / Сочетается с фоновой плиткой



Avorio Beige



R5QP 20x50 Decoro Raso Bianco

Abbinabile ai colori / Matching with colours / Mit den Grundfliesen kombinierbar / Peut s'associer aux carreaux de base de couleurs / Puede combinarse con los fondos / Сочетается с фоновой плиткой



Bianco Grigio



R5QQ 20x50 Decoro Raso Avorio

Abbinabile ai colori / Matching with colours / Mit den Grundfliesen kombinierbar / Peut s'associer aux carreaux de base de couleurs / Puede combinarse con los fondos / Сочетается с фоновой плиткой



Avorio Beige

PAVIMENTI COORDINATI / COORDINATED FLOOR TILES / KOORDINIERTE BODENFLIESEN / SOLS COORDONNES / PAVIMENTOS COORDINADOS / КООРДИНИРОВАННЫЕ ПОЛЫ

gres porcellanato / porcelain stoneware / feinsteinzeug / grès cérame émaillé / gres porcelánico / керамогранит

gruppo Bla UNI EN 14411\_G



## Bianco



R5K0 60x120 Rett  
R4EF 60x60 Rett  
R5J4 45x45  
R4HM 30x60 Rett  
R4NP 30x60 Strutt Rett

## Avorio

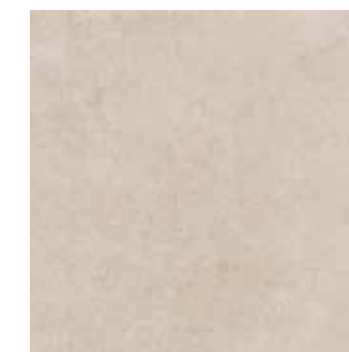

R5K1 60x120 Rett  
R4EG 60x60 Rett  
R5J5 45x45  
R4HN 30x60 Rett  
R4NQ 30x60 Strutt Rett

## Grigio



R5JZ 60x120 Rett  
R4EE 60x60 Rett  
R5J3 45x45  
R4HL 30x60 Rett  
R4NN 30x60 Strutt Rett

## Beige



R5K2 60x120 Rett  
R4EH 60x60 Rett  
R5J6 45x45  
R4KX 30x60 Rett  
R4NR 30x60 Strutt Rett

## Antracite



R5JY 60x120 Rett  
R4ED 60x60 Rett  
R5J2 45x45  
R4HK 30x60 Rett  
R4NM 30x60 Strutt Rett

# Creek Wall



R5HW Decoro Accordi Bianco 20x50 - 7<sup>78</sup>x19<sup>1316</sup> - R3RG Grigio 20x50 - 7<sup>78</sup>x19<sup>1316</sup>

## TECH INFO

DECORI / DECORATIVE PIECES / DEKORE / DÉCORS /  
DECORACIONES / ДЕКОРЫ

### Decoro Raso

Decoro con lustri/metalli preziosi utilizzabile a rivestimento; si consiglia la pulizia con detersivi neutri, non abrasivi. È sconsigliata la posa nell'area doccia / Decors with lustres/precious metals used for covering; we recommend cleaning with neutral, non-abrasive detergents. Tiles should not be installed in the shower area / Dekor mit Glanzelementen/Edelmetallen für die Wandverkleidung; es wird die Reinigung mit neutralen, scheuermittelfreien Reinigungsmitteln empfohlen. Die Verlegung in der Duschnische wird nicht empfohlen / Décor avec lustres/métaux précieux à poser sur le mur. Lavage recommandé avec des détergents neutres, non abrasifs. Pose déconseillée dans la douche / Decoración con elementos brillantes/metales preciosos utilizable para revestir superficies; se recomienda limpiarla con detergentes neutros, no abrasivos. Se desaconseja colocarla en el área de la ducha / Декор с блестящим покрытием/драгоценными металлами, используемый для облицовки; рекомендуется чистка с использованием нейтральных, неабразивных моющих средств. Не рекомендуется укладка в душевой зоне

### Mosaico

Mosaico preinciso da stuccare / Pre-cut mosaic, requires grouting / Mit Fugen zu verlegendes, vorgeschchnittenes Mosaik / Mosaïque pré-coupée à jointoyer / Mosaico preinciso para rejuntar / Мозаика с насечкой для затирки

## IMBALLI / PACKAGING / VERPACKUNGEN / EMBALLAGES / EMBALAJES / УПАКОВКИ

	scatole / box / karton / boîte / caja / короб			pallet / pallet / palette / palette / pallet / поддон			
	□	M²	KG	□	M²	KG	± mm
25x76	6	1,14	17,92	54	61,56	967,77	10
25x76	6	1,14	17,92	54	61,56	967,77	10
25x76	6	1,14	20,40	54	61,56	1103,00	10
20x50	14	1,40	20,90	48	67,20	1003,20	8,5
20x50	14	1,40	20,90	48	67,20	1003,20	8,5
20x50	14	1,40	20,90	48	67,20	1003,20	8,5
20x50	14	1,40	20,16	48	67,20	967,68	8,5
20x50	4	0,40	6,11	-	-	-	8,5

# Grace



R4CV Grigio SC. 20x50 - 7<sup>78</sup> x 19<sup>116</sup> - R4GE Decoro Bianco 20x50 - 7<sup>78</sup> x 19<sup>116</sup>

rivestimenti in pasta bianca / white body wall tiles / wandfliesen aus weissen ton scherben / revetements en pate blanche / revestimientos en pasta blanca / облицовка из белой глины

gruppo VIII UNI EN 14411\_L

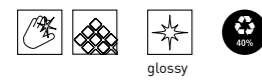

glossy

FORMATI / SIZES / FORMATE / FORMATS / FORMATOS / ФОРМАТЫ

20x50 cm

7<sup>78</sup> x 19<sup>116</sup>

± 8,5 mm

## Bianco



R4CT 20x50



R4DJ 20x50 Mosaico Bianco

Abbinabile ai colori / Matching with colours / Mit den Grundfliesen kombinierbar / Peut s'associer aux carreaux de base de couleurs / Puede combinarse con los fondos / Сочетается с фоновой плиткой



Bianco Grigio SC.

## Beige



R4CU 20x50



R4DK 20x50 Mosaico Beige

Abbinabile ai colori / Matching with colours / Mit den Grundfliesen kombinierbar / Peut s'associer aux carreaux de base de couleurs / Puede combinarse con los fondos / Сочетается с фоновой плиткой



Beige Beige SC.

## Grigio SC.



R4CV 20x50

## Beige SC.



R4CW 20x50

# Grace

20x50 - 7/8" x 19/16"

## Decors



**R46C** 20x50 Decoro

Abbinabile ai colori / Matching with colours / Mit den Grundfliesen kombinierbar / Peut s'associer aux carreaux de base de couleurs / Puede combinarse con los fondos / Сочетается с фоновой плиткой



**Bianco Grigio SC.**



**R46D** 20x50 Decoro

Abbinabile ai colori / Matching with colours / Mit den Grundfliesen kombinierbar / Peut s'associer aux carreaux de base de couleurs / Puede combinarse con los fondos / Сочетается с фоновой плиткой



**Beige Beige SC.**



**R46E** 20x50 Decoro

Abbinabile ai colori / Matching with colours / Mit den Grundfliesen kombinierbar / Peut s'associer aux carreaux de base de couleurs / Puede combinarse con los fondos / Сочетается с фоновой плиткой

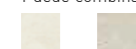

**Bianco Grigio SC.**



**R46F** 20x50 Decoro

Abbinabile ai colori / Matching with colours / Mit den Grundfliesen kombinierbar / Peut s'associer aux carreaux de base de couleurs / Puede combinarse con los fondos / Сочетается с фоновой плиткой

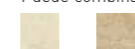

**Beige Beige SC.**



**R46G** 20x50 Decoro

Abbinabile ai colori / Matching with colours / Mit den Grundfliesen kombinierbar / Peut s'associer aux carreaux de base de couleurs / Puede combinarse con los fondos / Сочетается с фоновой плиткой



**Bianco Grigio SC.**



**R46H** 20x50 Decoro

Abbinabile ai colori / Matching with colours / Mit den Grundfliesen kombinierbar / Peut s'associer aux carreaux de base de couleurs / Puede combinarse con los fondos / Сочетается с фоновой плиткой

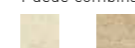

**Beige Beige SC.**

## TECH INFO

DECORI / DECORATIVE PIECES / DEKORE / DÉCORS / DECORACIONES / ДЕКОРЫ

### Decoro

Decoro con lustri/metalli preziosi utilizzabile a rivestimento; si consiglia la pulizia con detersivi neutri, non abrasivi. È sconsigliata la posa nell'area doccia / Decors with lustres/precious metals used for covering; we recommend cleaning with neutral, non-abrasive detergents. Tiles should not be installed in the shower area / Dekor mit Glanzelementen/Edelmetallen für die Wandverkleidung; es wird die Reinigung mit neutralen, scheuermittelfreien Reinigungsmitteln empfohlen. Die Verlegung in der Duschnische wird nicht empfohlen / Décor avec lustres/métaux précieux à poser sur le mur. Lavage recommandé avec des détergents neutres, non abrasifs. Pose déconseillée dans la douche / Decoración con elementos brillantes/metales preciosos utilizable para revestir superficies; se recomienda limpiarla con detergentes neutros, no abrasivos. Se desaconseja colocarla en el área de la ducha / Декор с блестящим покрытием/драгоценными металлами, используемый для облицовки; рекомендуется чистка с использованием нейтральных, неабразивных моющих средств. Не рекомендуется укладка в душевой зоне

### Mosaico

Mosaico preinciso da stuccare / Pre-cut mosaic, requires grouting / Mit Fugen zu verlegendes, vorgeschchnittenes Mosaik / Mosaïque pré-coupée à jointoyer / Mosaico preinciso para rejuntar / Мозаика с насечкой для затирки

## IMBALLI / PACKAGING / VERPACKUNGEN / EMBALLAGES / EMBALAJES / УПАКОВКИ

		scatole / box / karton / boîte / caja / короб			pallet / pallet / palette / palette / pallet / поддон			
		□	M²	KG	□	M²	KG	± mm
20x50		14	1,40	21,05	48	67,20	1010,47	8,5
20x50	Mosaico	14	1,40	21,05	48	67,20	1010,47	8,5
20x50	Decoro	4	0,40	6,15	-	-	-	-

# Land



R4CY Ivory 20x50 - 7<sup>7/8</sup>"x19<sup>11/16</sup>" - R4HZ Decoro Ivory 20x50 - 7<sup>7/8</sup>"x19<sup>11/16</sup>"

rivestimenti in pasta bianca / white body wall tiles / wandfliesen aus weissen ton scherben / revetements en pate blanche / revestimientos en pasta blanca / облицовка из белой глины

gruppo BIII UNI EN 14411\_L

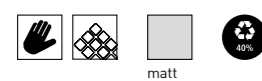

matt

FORMATI / SIZES / FORMATE / FORMATS / FORMATOS / ФОРМАТЫ

20x50 cm

7<sup>7/8</sup>"x19<sup>11/16</sup>"

± 8,5 mm

20x50 - 7<sup>7/8</sup>"x19<sup>11/16</sup>"

Ivory



R4CY 20x50

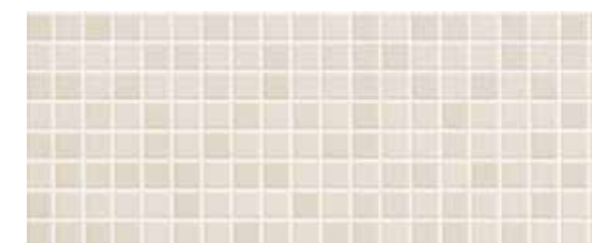

R4DE 20x50 Mosaico

Sand



R4CZ 20x50

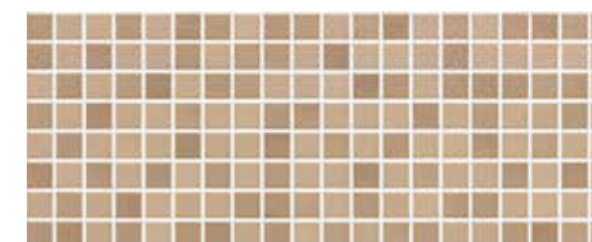

R4DF 20x50 Mosaico

Red



R4DA 20x50

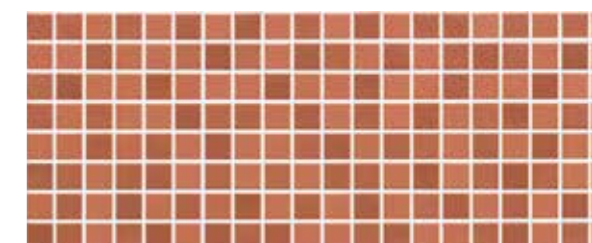

R4DG 20x50 Mosaico

White

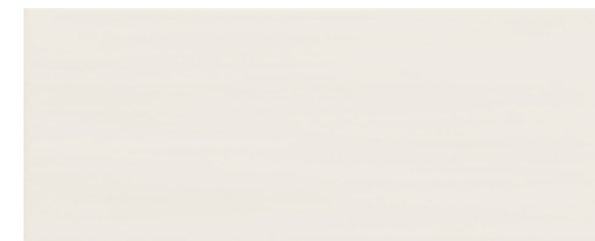

R4CX 20x50

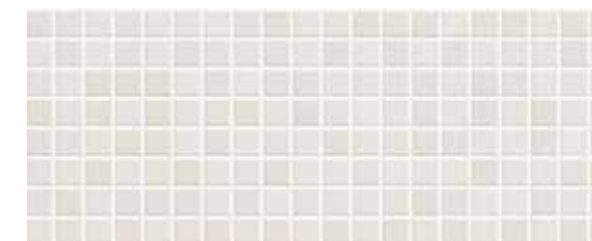

R4DD 20x50 Mosaico

Grey



R4JV 20x50

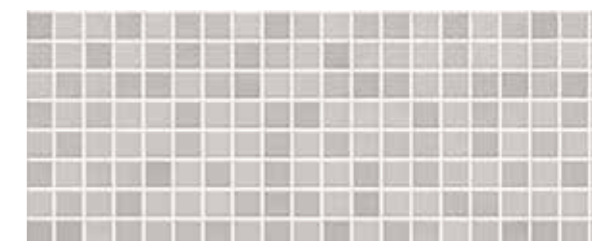

R4JW 20x50 Mosaico

# Land

20x50 - 7/8" x 19 1/16"

## Blue



R4DC 20x50

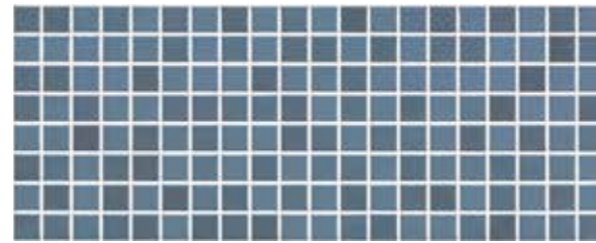

R4DH 20x50 Mosaico

## Decors



R4HZ 20x50 Decoro Ivory

Abbinabile ai colori / Matching with colours / Mit den Grundfliesen kombinierbar / Peut s'associer aux carreaux de base de couleurs / Puede combinarse con los fondos / Сочетается с фоновой плиткой



Ivory Sand



R4JA 20x50 Decoro White

Abbinabile ai colori / Matching with colours / Mit den Grundfliesen kombinierbar / Peut s'associer aux carreaux de base de couleurs / Puede combinarse con los fondos / Сочетается с фоновой плиткой

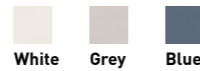

White Grey Blue



R4JC 20x50 Decoro Righe Ivory

Abbinabile ai colori / Matching with colours / Mit den Grundfliesen kombinierbar / Peut s'associer aux carreaux de base de couleurs / Puede combinarse con los fondos / Сочетается с фоновой плиткой



Ivory Sand



R4JD 20x50 Decoro Righe Grey

Abbinabile ai colori / Matching with colours / Mit den Grundfliesen kombinierbar / Peut s'associer aux carreaux de base de couleurs / Puede combinarse con los fondos / Сочетается с фоновой плиткой

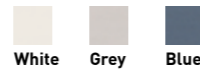

White Grey Blue



R4JE 20x50 Decoro Ivory\*

Abbinabile ai colori / Matching with colours / Mit den Grundfliesen kombinierbar / Peut s'associer aux carreaux de base de couleurs / Puede combinarse con los fondos / Сочетается с фоновой плиткой



Ivory Sand



R4LS 20x50 Decoro Grey\*

Abbinabile ai colori / Matching with colours / Mit den Grundfliesen kombinierbar / Peut s'associer aux carreaux de base de couleurs / Puede combinarse con los fondos / Сочетается с фоновой плиткой

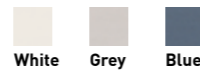

White Grey Blue

## TECH INFO

DECORI / DECORATIVE PIECES / DEKORE / DÉCORS / DECORACIONES / ДЕКОРЫ

### Decoro Righe

Decoro con lustri/metalli preziosi utilizzabile a rivestimento; si consiglia la pulizia con detersivi neutri, non abrasivi. È sconsigliata la posa nell'area doccia / Decors with lustres/precious metals used for covering; we recommend cleaning with neutral, non-abrasive detergents. Tiles should not be installed in the shower area / Dekor mit Glanzelementen/Edelmetallen für die Wandverkleidung; es wird die Reinigung mit neutralen, scheuermittelfreien Reinigungsmitteln empfohlen. Die Verlegung in der Duschnische wird nicht empfohlen / Décor avec lustres/métaux précieux à poser sur le mur. Lavage recommandé avec des détergents neutres, non abrasifs. Pose déconseillée dans la douche / Decoración con elementos brillantes/metales preciosos utilizable para revestir superficies; se recomienda limpiarla con detergentes neutros, no abrasivos. Se desaconseja colocarla en el área de la ducha / Декор с блестящим покрытием/драгоценными металлами, используемый для облицовки; рекомендуется чистка с использованием нейтральных, неабразивных моющих средств. Не рекомендуется укладка в душевой зоне

### Decoro Ivory\*, Decoro Grey\*

Il decoro ha una grafica direzionale, si consiglia di mantenere il verso in fase di posa / The patterning of the decoration has a set direction, which should be maintained during installation / Das Dekor ist richtungsgebunden. Es wird empfohlen, die Richtung bei der Verlegung beizubehalten / Le décor est directionnel. Il est recommandé de conserver le sens lors de la pose / La decoración presenta un gráfico direccional, por lo que se aconseja mantener el sentido durante la colocación / Графические элементы декора имеют определенное направление, которое мы рекомендуем соблюдать при укладке

### Mosaico

Mosaico preinciso da stuccare / Pre-cut mosaic, requires grouting / Mit Fugen zu verlegendes, vorgeschchnittenes Mosaik / Mosaïque pré-coupée à jointoyer / Mosaico preinciso para rejuntar / Мозаика с насечкой для затирки

## IMBALLI / PACKAGING / VERPACKUNGEN / EMBALLAGES / EMBALAJES / УПАКОВКИ

		scatole / box / karton / boîte / caja / коробк			pallet / pallet / palette / palette / pallet / поддон			
		□	M²	KG	□	M²	KG	± mm
20x50		14	1,40	21,05	48	67,20	1010,47	8,5
20x50	Mosaico	14	1,40	21,05	48	67,20	1010,47	8,5
20x50	Decoro	14	1,40	21,05	48	67,20	1010,47	8,5
20x50	Decoro Righe	4	0,40	6,15	-	-	-	-

# Replace Wall



R5JJ Replace Wall Decoro Tradizione Bianco 20x50 - 7<sup>7/8</sup> x 19<sup>11/16</sup> - R4NT Replace Grigio Rettificato 60x60 - 23<sup>5/8</sup> x 23<sup>5/8</sup>

rivestimenti in pasta bianca / white body wall tiles / wandfliesen aus weissen ton scherben / revetements en pate blanche / revestimientos en pasta blanca / облицовка из белой глины

gruppo BIII UNI EN 14411\_L

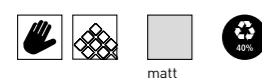

matt

FORMATI / SIZES / FORMATE / FORMATS / FORMATOS / ФОРМАТЫ

**25x76 cm**  
9<sup>13/16</sup> x 29<sup>15/16</sup>  
± 10 mm

**20x50 cm**  
7<sup>7/8</sup> x 19<sup>11/16</sup>  
± 8,5 mm

**SMART FLOOR**  
Replace > p.594

## Bianco

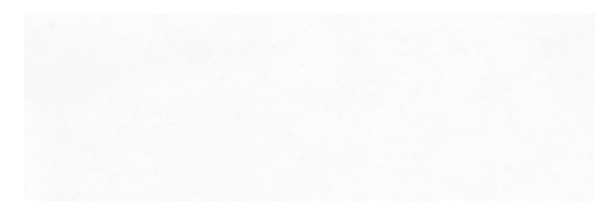

R9CL 25x76



R9CQ 25x76 Struttura Path 3D

## Grigio

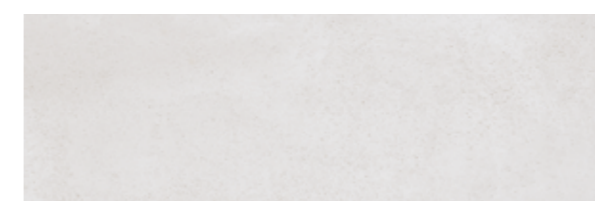

R9CX 25x76



R9DC 25x76 Struttura Path 3D

## Beige

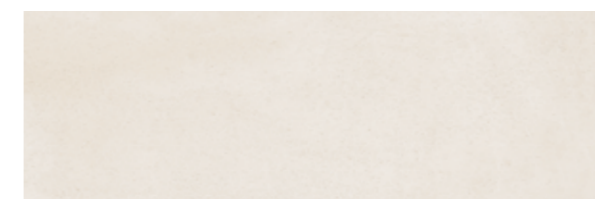

R9CM 25x76

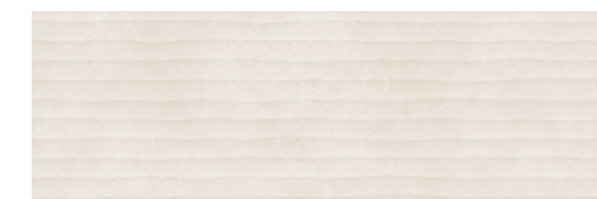

R9CR 25x76 Struttura Path 3D

## Tortora

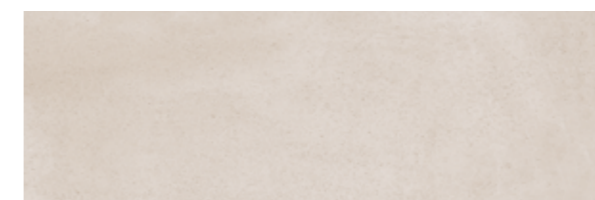

R9CN 25x76



R9CT 25x76 Struttura Path 3D



# Replace Wall

25x76 - 9<sup>13/16</sup> x 29<sup>15/16</sup> 20x50 - 7<sup>7/8</sup> x 19<sup>11/16</sup>

## Decors



**R9DF** 25x76 Decoro Equilibrio Grigio

Abbinabile ai colori / Matching with colours / Mit den Grundfliesen kombinierbar / Peut s'associer aux carreaux de base de couleurs / Puede combinarse con los fondos / Сочетается с фоновой плиткой



**Bianco** **Grigio**



**R9CV** 25x76 Decoro Equilibrio Beige

Abbinabile ai colori / Matching with colours / Mit den Grundfliesen kombinierbar / Peut s'associer aux carreaux de base de couleurs / Puede combinarse con los fondos / Сочетается с фоновой плиткой



**Beige** **Tortora**

## Bianco

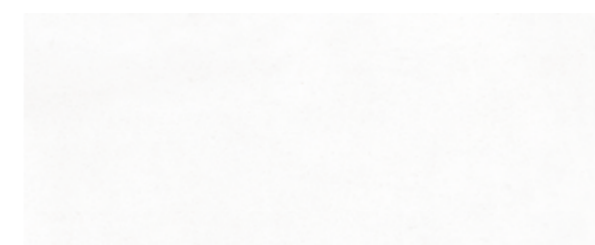

**R3QN** 20x50

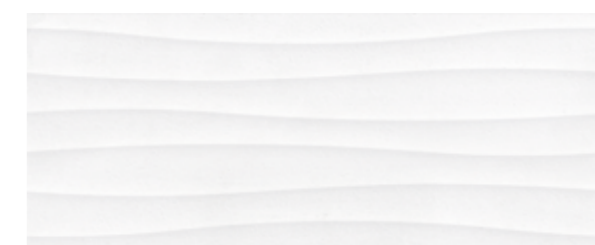

**R3QT** 20x50 Struttura Vento 3D

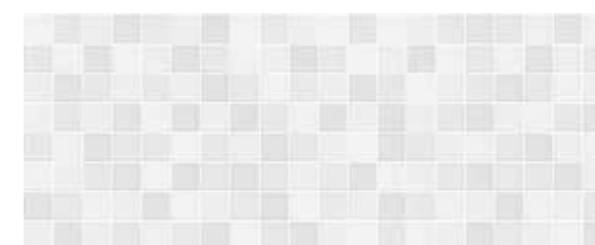

**R3QY** 20x50 Mosaico

## Grigio



**R3QQ** 20x50



**R3QV** 20x50 Struttura Vento 3D

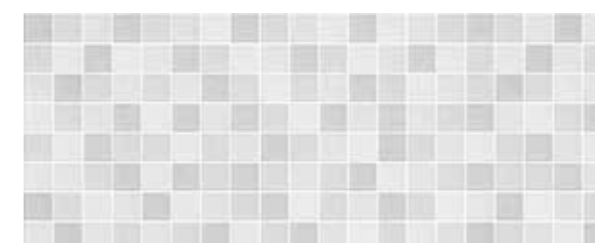

**R3RA** 20x50 Mosaico

## Antracite



**R3QS** 20x50



**R3QX** 20x50 Struttura Vento 3D

# Replace Wall

25x76 - 9<sup>13/16</sup> x 29<sup>15/16</sup> 20x50 - 7<sup>7/8</sup> x 19<sup>11/16</sup>

## Beige

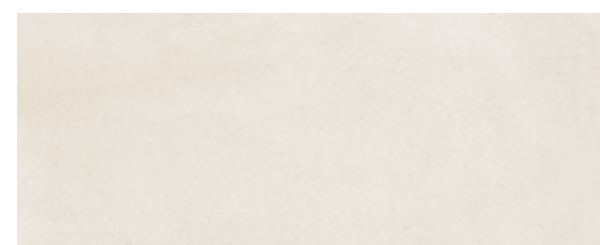

R3QP 20x50



R3QU 20x50 Struttura Vento 3D



R3QZ 20x50 Mosaico

## Tortora



R3QR 20x50



R3QW 20x50 Struttura Vento 3D

## Decors



R5PC 20x50 Decoro Ritmo Bianco

Abbinabile ai colori / Matching with colours / Mit den Grundfliesen kombinierbar / Peut s'associer aux carreaux de base de couleurs / Puede combinarse con los fondos / Сочетается с фоновой плиткой

Bianco Grigio Antracite



R5PD 20x50 Decoro Ritmo Beige

Abbinabile ai colori / Matching with colours / Mit den Grundfliesen kombinierbar / Peut s'associer aux carreaux de base de couleurs / Puede combinarse con los fondos / Сочетается с фоновой плиткой

Beige Tortora



R5JJ 20x50 Decoro Tradizione Bianco

Abbinabile ai colori / Matching with colours / Mit den Grundfliesen kombinierbar / Peut s'associer aux carreaux de base de couleurs / Puede combinarse con los fondos / Сочетается с фоновой плиткой

Bianco Grigio Antracite



R5JK 20x50 Decoro Tradizione Beige

Abbinabile ai colori / Matching with colours / Mit den Grundfliesen kombinierbar / Peut s'associer aux carreaux de base de couleurs / Puede combinarse con los fondos / Сочетается с фоновой плиткой

Beige Tortora

# Replace Wall

25x76 - 9<sup>13/16</sup> x 29<sup>15/16</sup> 20x50 - 7<sup>8/8</sup> x 19<sup>11/16</sup>

PAVIMENTI COORDINATI / COORDINATED FLOOR TILES / KOORDINIERTER BODENFLIESEN / SOLS COORDONNES / PAVIMENTOS COORDINADOS / КООРДИНИРОВАННЫЕ ПОЛЫ

gres porcellanato / porcelain stoneware / feinsteinzeug / grès cérame émaillé / gres porcelánico / керамогранит

gruppo Bia UNI EN 14411\_G



## Bianco



**R48Q** 60x120 Rett  
**R4NV** 60x60 Rett  
**R5JF** 60x60 Rett C2  
**R55K** 45x45  
**R4PF** 30x60 Rett  
**R4QE** 30x60 Strutt Rett

## Beige



**R48T** 60x120 Rett  
**R4NW** 60x60 Rett  
**R5JG** 60x60 Rett C2  
**R55L** 45x45  
**R4PG** 30x60 Rett  
**R4VY** 30x60 Strutt Rett

## Grigio



**R47Y** 60x120 Rett  
**R4NT** 60x60 Rett  
**R5JD** 60x60 Rett C2  
**R55J** 45x45  
**R4PE** 30x60 Rett  
**R4QD** 30x60 Strutt Rett

## Tortora



**R48N** 60x120 Rett  
**R4NU** 60x60 Rett  
**R5JH** 60x60 Rett C2  
**R55M** 45x45  
**R4PH** 30x60 Rett  
**R4VZ** 30x60 Strutt Rett

## Antracite



**R47S** 60x120 Rett  
**R4NS** 60x60 Rett  
**R5JA** 60x60 Rett C2  
**R52J** 45x45  
**R4PD** 30x60 Rett  
**R4QC** 30x60 Strutt Rett

## TECH INFO

DECORI / DECORATIVE PIECES / DEKORE / DÉCORS /  
 DECORACIONES / ДЕКОРЫ

### Decoro Ritmo

Decoro con lustri/metalli preziosi utilizzabile a rivestimento; si consiglia la pulizia con detersivi neutri, non abrasivi. È sconsigliata la posa nell'area doccia / Decors with lustres/precious metals used for covering; we recommend cleaning with neutral, non-abrasive detergents. Tiles should not be installed in the shower area / Dekor mit Glanzelementen/Edelmetallen für die Wandverkleidung; es wird die Reinigung mit neutralen, scheuermittelfreien Reinigungsmitteln empfohlen. Die Verlegung in der Duschnische wird nicht empfohlen / Décor avec lustres/métaux précieux à poser sur le mur. Lavage recommandé avec des détergents neutres, non abrasifs. Pose déconseillée dans la douche / Decoración con elementos brillantes/metales preciosos utilizable para revestir superficies; se recomienda limpiarla con detergentes neutros, no abrasivos. Se desaconseja colocarla en el área de la ducha / Декор с блестящим покрытием/драгоценными металлами, используемый для облицовки; рекомендуется чистка с использованием нейтральных, неабразивных моющих средств. Не рекомендуется укладка в душевой зоне

### Mosaico

Mosaico preinciso da stuccare / Pre-cut mosaic, requires grouting / Mit Fugen zu verlegendes, vorgeschchnittenes Mosaik / Mosaïque pré-coupée à jointoyer / Mosaico preinciso para rejuntar / Мозаика с насечкой для затирки

CLASSIFICAZIONE / CLASSIFICATION / KLASSIFIZIERUNG /  
 CLASSIFICATION / CLASIFICACIÓN / КЛАССИФИКАЦИЯ

### C2

Classificazione in base alla normativa spagnola UNE - ENV 12633:2003 / Classification according to Spanish standard UNE - ENV 12633:2003 / Klassifizierung gemäß der spanischen Norm UNE - ENV 12633:2003 / Classification selon la norme espagnole UNE-ENV 12633:2003 / Clasificación con arreglo a la norma española UNE - ENV 12633:2003 / Классификация в соответствии с испанским стандартом UNE - ENV 12633:2003

IMBALLI / PACKAGING / VERPACKUNGEN / EMBALLAGES / EMBALAJES / УПАКОВКИ

		scatole / box / karton / boîte / caja / короб			pallet / pallet / palette / palette / pallet / поддон			
		□	M²	KG	□	M²	KG	± mm
25x76		6	1,14	20,40	54	61,56	1103,00	10
25x76	Struttura Path 3D	6	1,14	20,40	54	61,56	1103,00	10
25x76	Decoro Equilibrio	6	1,14	20,40	54	61,56	1103,00	10
20x50		14	1,40	21,05	48	67,20	1010,47	8,5
20x50	Struttura Vento 3D	14	1,40	21,05	48	67,20	1010,47	8,5
20x50	Mosaico	14	1,40	21,05	48	67,20	1010,47	8,5
20x50	Decoro Tradizione	14	1,40	19,88	48	67,20	954,53	8,5
20x50	Decoro Ritmo	4	0,40	6,15	-	-	-	-

SMART FLOOR  
 Replace > p.594

# Casablanca Wall



R3TQ Wall Grigio 25x38 - 9<sup>13</sup>/<sub>16</sub>"x14<sup>15</sup>/<sub>16</sub>" - R3VQ Wall Mosaico Grigio 25x38 - 9<sup>13</sup>/<sub>16</sub>"x14<sup>15</sup>/<sub>16</sub>"

gruppo BIII UNI EN 14411\_L

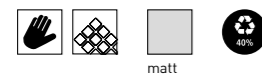

matt

FORMATI / SIZES / FORMATE / FORMATS / FORMATOS / ФОРМАТЫ

25x38 cm  
9<sup>13</sup>/<sub>16</sub>"x14<sup>15</sup>/<sub>16</sub>"  
± 8,5 mm

SMART FLOOR  
Casablanca > p.598

Bianco



R3XP 25x38

Grigio



R3TQ 25x38



R3WZ 25x38 Decoro

Antracite



R3TR 25x38



R3WY 25x38 Decoro

Beige



R3TM 25x38



R3WV 25x38 Decoro

Creta



R3TN 25x38



R3WV 25x38 Decoro

# Casablanca Wall

25x38 - 9<sup>13/16</sup>"x14<sup>15/16</sup>" 4,5x38 - 1<sup>3/4</sup>"x14<sup>15/16</sup>"

## Marrone



R3TP 25x38



R3WX 25x38 Decoro

## Decors



R3XA 25x38 Decoro Marrone\*



R3XC 25x38 Decoro Antracite\*



R3XD 25x38 Decoro Beige

Abbinabile ai colori / Matching with colours / Mit den Grundfliesen kombinierbar / Peut s'associer aux carreaux de base de couleurs / Puede combinarse con los fondos / Сочетается с фоновой плиткой



Beige Creta Marrone

Abbinabile ai colori / Matching with colours / Mit den Grundfliesen kombinierbar / Peut s'associer aux carreaux de base de couleurs / Puede combinarse con los fondos / Сочетается с фоновой плиткой

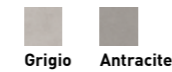

Grigio Antracite



R3WU 4,5x38 L. Grigio



R3WT 4,5x38 L. Beige

## TECH INFO

DECORI / DECORATIVE PIECES / DEKORE / DÉCORS / DECORACIONES / ДЕКОРЫ

### Decoro Marrone\*, Decoro Antracite\*

Decoro con lustrati/metalli preziosi utilizzabile a rivestimento; si consiglia la pulizia con detersivi neutri, non abrasivi. È sconsigliata la posa nell'area doccia / Decors with lustres/precious metals used for covering; we recommend cleaning with neutral, non-abrasive detergents.

Tiles should not be installed in the shower area / Dekor mit Glanzelementen/Edelmetallen für die Wandverkleidung; es wird die Reinigung mit neutralen, scheuermittelfreien Reinigungsmitteln empfohlen. Die Verlegung in der Duschnische wird nicht empfohlen / Décor avec lustres/métaux précieux à poser sur le mur.

Lavage recommandé avec des détergents neutres, non abrasifs.

Pose déconseillée dans la douche / Decoración con elementos brillantes/metales preciosos utilizable para revestir superficies;

se recomienda limpiarla con detergentes neutros, no abrasivos.

Se desaconseja colocarla en el área de la ducha / Декор с блестящим покрытием/драгоценными металлами, используемый для облицовки; рекомендуется чистка с использованием нейтральных, неабразивных моющих средств. Не рекомендуется укладка в душевой зоне

## IMBALLI / PACKAGING / VERPACKUNGEN / EMBALLAGES / EMBALAJES / УПАКОВКИ

		scatole / box / karton / boîte / caja / коробк			pallet / pallet / palette / palette / pallet / поддон			
		□	M²	KG	□	M²	KG	± mm
25x38		14	1,33	19,40	54	71,82	1047,86	8,5
25x38	Decoro	14	1,33	19,40	54	71,82	1047,86	8,5
25x38	Decoro R3XA, R3XC, R3XD	4	0,38	5,48	-	-	-	-
4,5x38	L.	6	0,10	1,48	-	-	-	-

# Craft



R2YH Decoro Liberty Grigio 25x38 - 9<sup>13/16</sup>"x14<sup>15/16</sup>"

rivestimenti in pasta bianca / white body wall tiles / wandfliesen aus weissen ton scherben / revetements en pate blanche / revestimientos en pasta blanca / облицовка из белой глины

gruppo BIII UNI EN 14411\_L

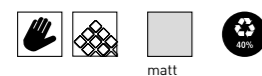

matte

FORMATI / SIZES / FORMATE / FORMATS / FORMATOS / ФОРМАТЫ

25x38 cm

9<sup>13/16</sup>"x14<sup>15/16</sup>"

± 8,5 mm

25x38 - 9<sup>13/16</sup>"x14<sup>15/16</sup>"

## Beige



R2FP 25x38



R2SF 25x38 Struttura Marea 3D



R2FT 25x38 Mosaico

## Bianco

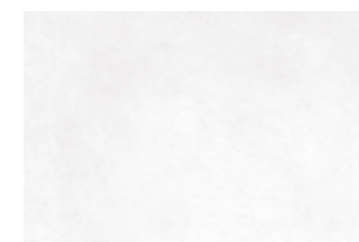

R2FQ 25x38



R2TC 25x38 Struttura Marea 3D

## Grigio

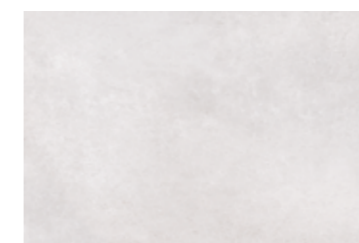

R2FR 25x38



R2TD 25x38 Struttura Marea 3D

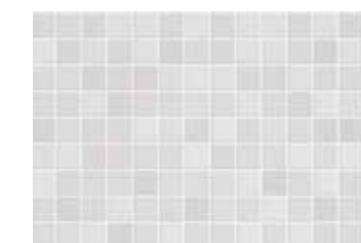

R2FU 25x38 Mosaico

## Blu

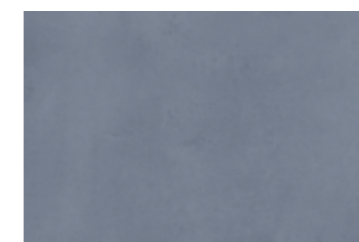

R2FS 25x38

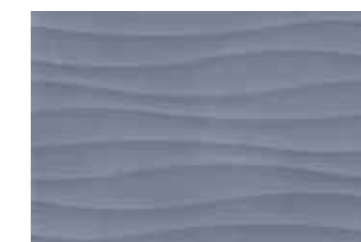

R2VQ 25x38 Struttura Marea 3D

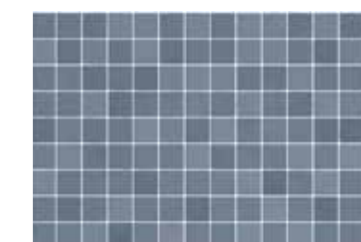

R2KL 25x38 Mosaico

# Craft

25x38 - 9<sup>13/16</sup>"x14<sup>15/16</sup>"

## Decors



**R2YG** 25x38 Decoro Liberty Beige

Abbinabile ai colori / Matching with colours /  
Mit den Grundfliesen kombinierbar /  
Peut s'associer aux carreaux de base de  
couleurs / Puede combinarse con los fondos /  
Сочетается с фоновой плиткой



**Beige Blu**



**R2YH** 25x38 Decoro Liberty Grigio

Abbinabile ai colori / Matching with colours /  
Mit den Grundfliesen kombinierbar /  
Peut s'associer aux carreaux de base de  
couleurs / Puede combinarse con los fondos /  
Сочетается с фоновой плиткой



**Bianco Grigio Blu**



**R2VR** 25x38 Decoro Relax Beige

Abbinabile ai colori / Matching with colours /  
Mit den Grundfliesen kombinierbar /  
Peut s'associer aux carreaux de base de  
couleurs / Puede combinarse con los fondos /  
Сочетается с фоновой плиткой



**Beige**



**R2YF** 25x38 Decoro Relax Grigio

Abbinabile ai colori / Matching with colours /  
Mit den Grundfliesen kombinierbar /  
Peut s'associer aux carreaux de base de  
couleurs / Puede combinarse con los fondos /  
Сочетается с фоновой плиткой

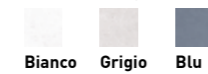

**Bianco Grigio Blu**

## TECH INFO

DECORI / DECORATIVE PIECES / DEKORE / DÉCORS /  
DECORACIONES / ДЕКОРЫ

### Mosaico

Mosaico preinciso da stuccare / Pre-cut mosaic, requires grouting /  
Mit Fugen zu verlegendes, vorgeschchnittenes Mosaik / Mosaïque  
pré-coupée à jointoyer / Mosaico preinciso para rejuntar /  
Мозаика с насечкой для затирки

## IMBALLI / PACKAGING / VERPACKUNGEN / EMBALLAGES / EMBALAJES / УПАКОВКИ

		scatole / box / karton / boîte / caja / коробк			pallet / pallet / palette / palette / pallet / поддон			
		□	M²	KG	□	M²	KG	± mm
25x38		14	1,33	19,60	54	71,82	1058,46	8,5
25x38	Struttura 3D	14	1,33	19,60	54	71,82	1058,46	8,5
25x38	Decoro, Mosaico	14	1,33	19,60	54	71,82	1058,46	8,5

# Energy



R01D Avorio Struttura Marea 3D 25x38 - 9<sup>13/16</sup>"x14<sup>15/16</sup>"

rivestimenti in pasta bianca / white body wall tiles / wandfliesen aus weissen ton scherben / revetements en pate blanche / revestimientos en pasta blanca / облицовка из белой глины

gruppo VIII UNI EN 14411\_L



FORMATI / SIZES / FORMATE / FORMATS / FORMATOS / ФОРМАТЫ

25x38 cm  
9<sup>13/16</sup>"x14<sup>15/16</sup>"  
± 8,5 mm

25x38 - 9<sup>13/16</sup>"x14<sup>15/16</sup>"

## Bianco



R00V 25x38



R01B 25x38 Struttura Marea 3D

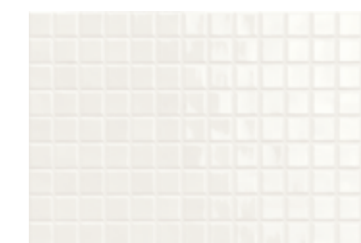

R01E 25x38 Mosaico

## Perla



R00W 25x38



R019 25x38 Struttura Marea 3D

## Avorio



R011 25x38



R01D 25x38 Struttura Marea 3D

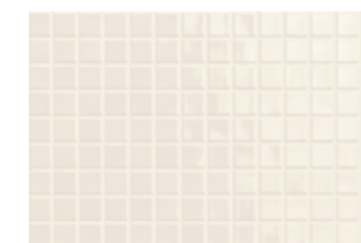

R01G 25x38 Mosaico

## Turchese



R00X 25x38



R01A 25x38 Struttura Marea 3D

## Indaco



R00Y 25x38



R01C 25x38 Struttura Marea 3D



# Energy

25x38 - 9<sup>13/16</sup>"x14<sup>15/16</sup>"

## Magenta



R00Z 25x38

## Decors



R01J 25x38 Decoro Faience Bianco

Abbinabile ai colori / Matching with colours /  
Mit den Grundfliesen kombinierbar /  
Peut s'associer aux carreaux de base de  
couleurs / Puede combinarse con los fondos /  
Сочетается с фоновой плиткой



R01K 25x38 Decoro Faience Avorio

Abbinabile ai colori / Matching with colours /  
Mit den Grundfliesen kombinierbar /  
Peut s'associer aux carreaux de base de  
couleurs / Puede combinarse con los fondos /  
Сочетается с фоновой плиткой



R12U 25x38 Decoro Kimono Bianco

Abbinabile ai colori / Matching with colours /  
Mit den Grundfliesen kombinierbar /  
Peut s'associer aux carreaux de base de  
couleurs / Puede combinarse con los fondos /  
Сочетается с фоновой плиткой



R12V 25x38 Decoro Kimono Avorio

Abbinabile ai colori / Matching with colours /  
Mit den Grundfliesen kombinierbar /  
Peut s'associer aux carreaux de base de  
couleurs / Puede combinarse con los fondos /  
Сочетается с фоновой плиткой



## TECH INFO

DECORI / DECORATIVE PIECES / DEKORE / DÉCORS /  
DECORACIONES / ДЕКОРЫ

### Mosaico

Mosaico preinciso da stuccare / Pre-cut mosaic, requires grouting /  
Mit Fugen zu verlegendes, vorgeschchnittenes Mosaik / Mosaïque  
pré-coupée à jointoyer / Mosaico preinciso para rejuntar /  
Мозаика с насечкой для затирки

## IMBALLI / PACKAGING / VERPACKUNGEN / EMBALLAGES / EMBALAJES / УПАКОВКИ

		scatole / box / karton / boîte / caja / коробк			pallet / pallet / palette / palette / pallet / поддон			
		□	M²	KG	□	M²	KG	± mm
25x38		14	1,33	19,92	54	71,82	1075,80	8,5
25x38	Struttura 3D	14	1,33	20,41	54	71,82	1102,10	8,5
25x38	Mosaico	14	1,33	20,41	54	71,82	1102,10	8,5
25x38	Decoro Faience	14	1,33	20,01	54	71,82	1080,55	8,5
25x38	Decoro Kimono	4	0,38	6,00	-	-	-	-

# Feel

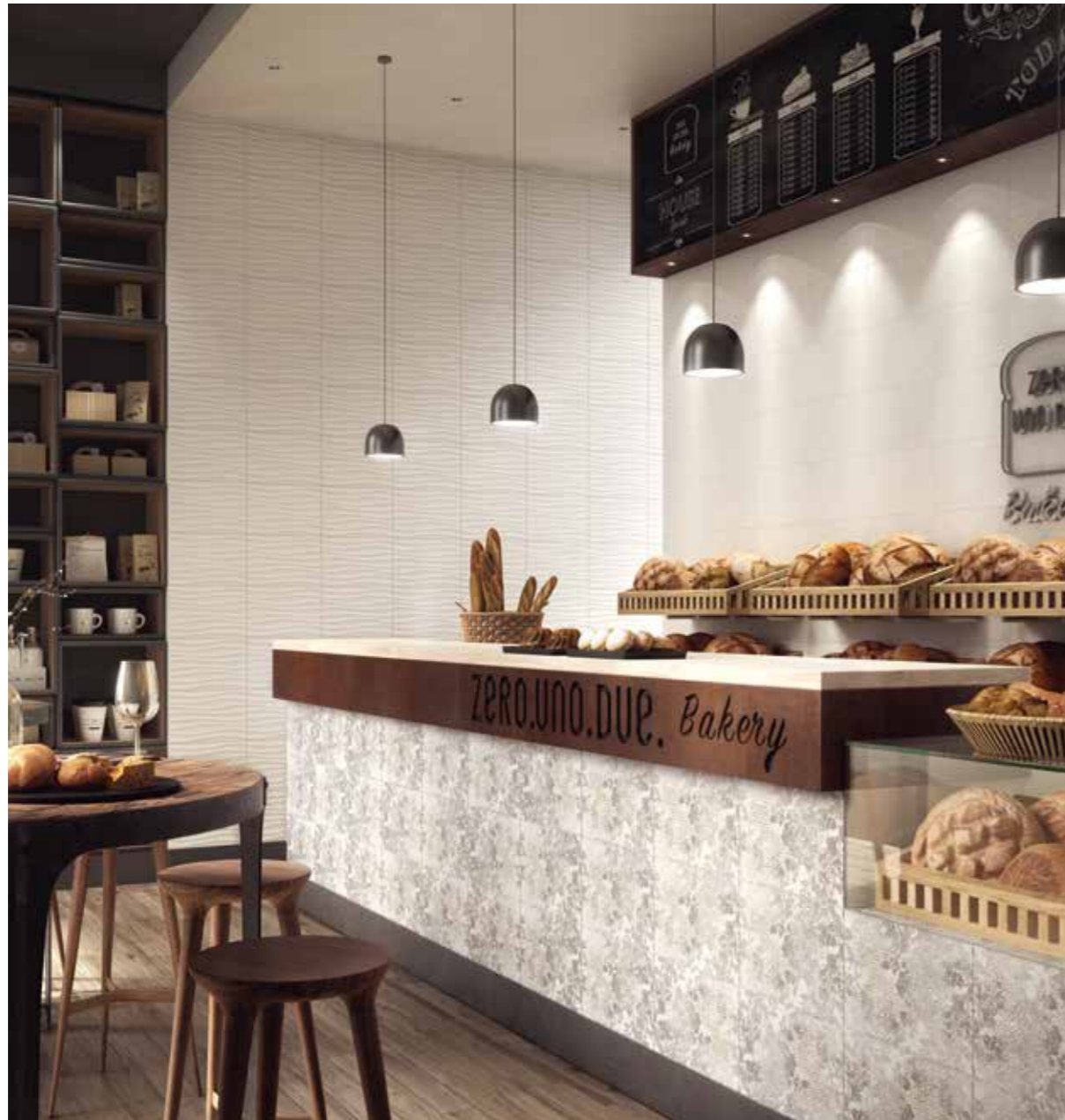

R01M Bianco 25x38 - 9<sup>13</sup>/<sub>16</sub>"x14<sup>15</sup>/<sub>16</sub>" - R01U Bianco Struttura Marea 3D 25x38 - 9<sup>13</sup>/<sub>16</sub>"x14<sup>15</sup>/<sub>16</sub>" - R11U Decoro Wallpaper Grigio 25x38 - 9<sup>13</sup>/<sub>16</sub>"x14<sup>15</sup>/<sub>16</sub>"

rivestimenti in pasta bianca / white body wall tiles / wandfliesen aus weissen ton scherben / revetements en pate blanche / revestimientos en pasta blanca / облицовка из белой глины

gruppo VIII UNI EN 14411\_L

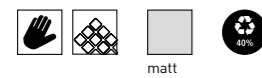

matt

FORMATI / SIZES / FORMATE / FORMATS / FORMATOS / ФОРМАТЫ

25x38 cm

9<sup>13</sup>/<sub>16</sub>"x14<sup>15</sup>/<sub>16</sub>"

± 8,5 mm

25x38 - 9<sup>13</sup>/<sub>16</sub>"x14<sup>15</sup>/<sub>16</sub>"

## Bianco



R01M 25x38



R01U 25x38 Struttura Marea 3D

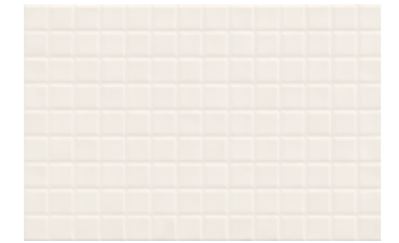

R01Z 25x38 Mosaico

## Grigio



R01N 25x38

## Cenere



R01P 25x38



R01V 25x38 Struttura Marea 3D

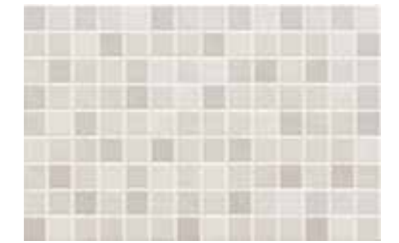

R020 25x38 Mosaico

## Avorio



R01T 25x38



R01Y 25x38 Struttura Marea 3D

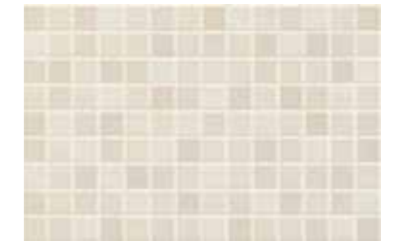

R024 25x38 Mosaico

## Tortora



R01S 25x38



R01X 25x38 Struttura Marea 3D

# Feel

25x38 - 9<sup>13/16</sup>"x14<sup>15/16</sup>"

## Corallo



R01R 25x38

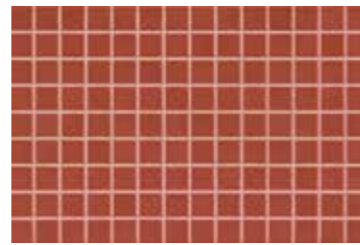

R02Z 25x38 Mosaico

## Blu



R01Q 25x38



R01W 25x38 Struttura Marea 3D

## Decors



R025 25x38 Decoro Fusion Bianco

Abbinabile ai colori / Matching with colours / Mit den Grundfliesen kombinierbar / Peut s'associer aux carreaux de base de couleurs / Puede combinarse con los fondos / Сочетается с фоновой плиткой



Bianco Grigio Cenere Blu



R02A 25x38 Decoro Fusion Avorio

Abbinabile ai colori / Matching with colours / Mit den Grundfliesen kombinierbar / Peut s'associer aux carreaux de base de couleurs / Puede combinarse con los fondos / Сочетается с фоновой плиткой



Avorio Tortora Corallo



R11U 25x38 Decoro Wallpaper Grigio

Abbinabile ai colori / Matching with colours / Mit den Grundfliesen kombinierbar / Peut s'associer aux carreaux de base de couleurs / Puede combinarse con los fondos / Сочетается с фоновой плиткой

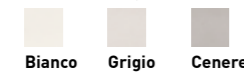

Bianco Grigio Cenere



R11T 25x38 Decoro Wallpaper Avorio

Abbinabile ai colori / Matching with colours / Mit den Grundfliesen kombinierbar / Peut s'associer aux carreaux de base de couleurs / Puede combinarse con los fondos / Сочетается с фоновой плиткой



Avorio Tortora

## TECH INFO

DECORI / DECORATIVE PIECES / DEKORE / DÉCORS / DECORACIONES / ДЕКОРЫ

### Decoro Wallpaper

Decoro con lustrati/metalli preziosi utilizzabile a rivestimento; si consiglia la pulizia con detersivi neutri, non abrasivi. È sconsigliata la posa nell'area doccia / Decors with lustres/precious metals used for covering; we recommend cleaning with neutral, non-abrasive detergents. Tiles should not be installed in the shower area / Dekor mit Glanzelementen/Edelmetallen für die Wandverkleidung; es wird die Reinigung mit neutralen, scheuermittelfreien Reinigungsmitteln empfohlen. Die Verlegung in der Duschnische wird nicht empfohlen / Décor avec lustres/métaux précieux à poser sur le mur. Lavage recommandé avec des détergents neutres, non abrasifs. Pose déconseillée dans la douche / Decoración con elementos brillantes/metales preciosos utilizable para revestir superficies; se recomienda limpiarla con detergentes neutros, no abrasivos. Se desaconseja colocarla en el área de la ducha / Декор с блестящим покрытием/драгоценными металлами, используемый для облицовки; рекомендуется чистка с использованием нейтральных, неабразивных моющих средств. Не рекомендуется укладка в душевой зоне

### Mosaico

Mosaico preinciso da stuccare / Pre-cut mosaic, requires grouting / Mit Fugen zu verlegendes, vorgeschchnittenes Mosaik / Mosaïque pré-coupée à jointoyer / Mosaico preinciso para rejuntar / Мозаика с насечкой для затирки

## IMBALLI / PACKAGING / VERPACKUNGEN / EMBALLAGES / EMBALAJES / УПАКОВКИ

		scatole / box / karton / boîte / caja / короб			pallet / pallet / palette / palette / pallet / поддон			
		□	M²	KG	□	M²	KG	± mm
25x38		14	1,33	19,62	54	71,82	1059,36	8,5
25x38	Struttura 3D	14	1,33	17,80	54	71,82	961,04	8,5
25x38	Mosaico	14	1,33	20,41	54	71,82	1102,10	8,5
25x38	Decoro Fusion	14	1,33	20,01	54	71,82	1080,55	8,5
25x38	Decoro Wallpaper	4	0,38	6,01	-	-	-	-

# Unitech Wall



R1UB Wall Beige Lux 10x30 - 3<sup>15/16</sup>"x11<sup>13/16</sup>" - R1TY Wall Beige Diamantato Lux 10x30 - 3<sup>15/16</sup>"x11<sup>13/16</sup>"



matt glossy

FORMATI / SIZES / FORMATE / FORMATS / FORMATOS / ФОРМАТЫ

<b>20x20 cm</b> 7 <sup>7/8</sup> "x7 <sup>7/8</sup> " ± 7,2 mm - 8mm	<b>10x30 cm</b> 3 <sup>15/16</sup> "x11 <sup>13/16</sup> " ± 7,5 mm	<b>10x10 cm</b> 3 <sup>15/16</sup> "x3 <sup>15/16</sup> " ± 7 mm
--	---	--

SMART FLOOR  
Unitech > p.626

## Bianco

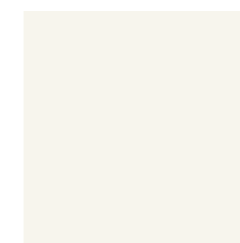

RN46 20x20  
OT98 20x20 Lux  
R1UT 10x30  
R1U8 10x30 Lux  
94D9 10x10  
4Y29 10x10 Lux  
94F1 10x10 PC  
4Y39 10x10 PC Lux

## Cristallo



R1NO 20x20  
R1PF 20x20 Lux

## Argento



R1NL 20x20  
R1PC 20x20 Lux  
R1UU 10x30  
R1U9 10x30 Lux  
R1QH 10x10

## Cenere



RN50 20x20  
OT96 20x20 Lux

## Nero



RN51 20x20  
OT97 20x20 Lux  
R1UV 10x30  
R1UA 10x30 Lux  
94E2 10x10

## Beige



R1NJ 20x20  
R1PA 20x20 Lux  
R1UW 10x30  
R1UB 10x30 Lux

## Crema



R1NM 20x20  
R1PD 20x20 Lux

## Incenso



R1NZ 20x20  
R1UX 10x30

# Unitech Wall

20x20 - 7<sup>7/8</sup>"x7<sup>7/8</sup>" 10x30 - 3<sup>15/16</sup>"x11<sup>13/16</sup>" 10x10 - 3<sup>15/16</sup>"x3<sup>15/16</sup>"

## Lime



R1NN 20x20  
R1PE 20x20 Lux  
R1UZ 10x30  
R1UD 10x30 Lux

## Menta



R1NT 20x20  
R1PK 20x20 Lux

## Rubino



R1NY 20x20  
R1PQ 20x20 Lux  
R1VC 10x30  
R1UI 10x30 Lux

## Smeraldo



R1NW 20x20  
R1PN 20x20 Lux

## Turchese



R1NX 20x20  
R1PP 20x20 Lux  
R1VO 10x30  
R1UE 10x30 Lux

## Diamantato\*

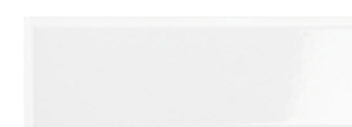

R1TW 10x30 Bianco Lux

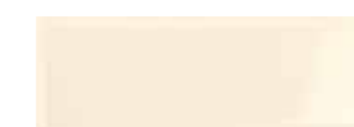

R1TY 10x30 Beige Lux

## Topazio



R1NV 20x20  
R1PM 20x20 Lux

## Oceano



R1NR 20x20  
R1VA 10x30  
R1UF 10x30 Lux



R1U5 10x30 Turchese Lux



R1U7 10x30 Oceano Lux

## Giallo



R1NQ 20x20  
R1PH 20x20 Lux  
R1VB 10x30  
R1UG 10x30 Lux

## Arancio



R1NK 20x20  
R1PB 20x20 Lux



R1TX 10x30 Nero Lux

### Diamantato\* / Bevelled / Abgerundet / Biseauté / Biselado / C фаской

Struttura a rilievo di spessore complessivo 9 mm, abbinabile al formato 10x30 Lux di spessore 7,5 mm / Relief texture with a total thickness of 9mm; can be used along with the 7.5 mm thick 10x30 lux size / Reliefstruktur mit einer Gesamtstärke von 9 mm passend zum Format 10x30 lux mit 7,5 mm Stärke / Structure en relief d'une épaisseur totale de 9 mm pouvant être associée au format 10x30 lux de 7,5 mm d'épaisseur / Estructura en relieve de espesor total 9 mm combinable con el formato 10x30 lux de 7,5 mm de espesor / Рельефная структура общей толщиной 9 мм, сочетаемая с форматом 10x30 люкс толщиной 7,5 мм

### IMBALLI / PACKAGING / VERPACKUNGEN / EMBALLAGES / EMBALAJES / УПАКОВКИ

		scatole / box / karton / boîte / caja / коробк			pallet / pallet / palette / palette / pallet / поддон				
		□	M²	KG	☐	M²	KG	± mm	gruppo EN
20x20	Matt, Lux	35	1,40	17,90	75	105,00	1342,00	7,2	BIII EN14411_L
10x30		36	1,08	16,87	66	71,28	1113,58	7,5	BIIb EN14411_J
10x30	Lux	34	1,02	13,96	66	67,32	921,43	7,5	BIIb EN14411_K
10x30	Diamantato	28	0,84	14,80	66	55,44	976,91	9	BIII EN14411_L
10x10		100	1,00	12,10	72	72,00	871,25	7	BIIa EN14411_J
10x10	Lux	100	1,00	13,10	72	72,00	943,15	7	BIIb EN14411_K
10x10	PC	96	1,00	12,96	66	66,02	855,64	7	BIIa EN14411_J
10x10	PC Lux	96	1,00	12,96	66	66,02	855,64	7	BIIb EN14411_K

# APPENDIX



- 682** Lettura del catalogo  
reading the catalogue / benützung  
des kataloges / la lecture du  
catalogue / la lectura del catálogo /  
чтение каталога
- 684** Legenda  
legend / legende / legende /  
leyenda / условные знаки
- 686** Simbologia  
key to symbols / symbole /  
symbologie / simbologia / символы
- 687** Tecnologie  
technologies / technologien /  
technologies / tecnologías /  
технологии
- 688** Variazioni cromatiche  
colour variations / colour variations /  
variations chromatiques /  
farbvariationen / variaciones  
cromáticas / варианты оттенка
- 689** Destinazioni d'uso  
intended uses /  
anwendungsbereichen /  
champs d'application /  
usos previstos / назначение
- 690** Pezzi speciali  
trims / spezialteile / pièces  
spéciales / piezas especiales /  
специальные изделия
- 692** Certificazioni  
certifications / zertifizierungen /  
certifications / certificaciones /  
сертификации
- 698** Qualità e ambiente  
quality and environment /  
qualität und umwelt /  
la qualité et l'environnement /  
calidad y ambiente / качество  
и окружающая среда
- 700** Le norme UNI EN  
UNI EN regulations / die UNI  
EN-normen / les normes UNI EN /  
las normas UNI EN / нормы UNI EN
- 702** Caratteristiche tecniche  
MAIORA  
technical characteristics /  
technische eigenschaften /  
caracteristiques  
technique / datos técnicos /  
технические характеристики
- 706** Imballaggio  
INCANTO & MAIORA  
packaging / verpackung /  
emballage / embalajes /  
упаковка
- 708** Consigli di posa  
e manutenzione  
advice for laying and maintenance /  
verlegungs- und Pflegehinweise /  
conseils pour la pose et l'entretien /  
consejos de colocación y  
mantenimiento / рекомендации  
по укладке и уходу
- 714** Norme di trattamento  
treatment procedures / normes de  
traitement / behandlungshinweise /  
normas de tratamiento /  
правила промывки

# Lettura del catalogo

reading the catalogue / benützung des kataloges / la lecture du catalogue / la lectura del catálogo / чтение каталога

**serie**  
series / serie / serie / серия

## Re\_Solution

gres fine porcellanato colorato in massa - rettificato monocalibro / colorbody fine porcelain stoneware - rectified monocaliber / durchgefärbtes feinsteinzeug - rektifiziert, in einem werkmaß / grès cérame fin coloré dans la masse - rectifié monocalibre / gres porcelánico fino coloreado en toda la masa - rectificado monocalibre / гомогенный мелкозернистый керамогранит - ректифицированный монокалиберный

gruppo Bia UNI EN 14411\_6

**tecnologia**  
technology / technik / la technologie / tecnologia / технология



natural/matt  
glossy  
outdoor

**caratteristiche tecniche, superfici, certificazioni**  
technical characteristics, surfaces, certifications / technische eigenschaften, oberflächen, zertifizierungen / caracteristiques technique, finitions, certifications / datos tecnicos, superficies, certificaciones / технические характеристики, поверхности, сертификаты

**formati**  
size / formats / formats / форматы

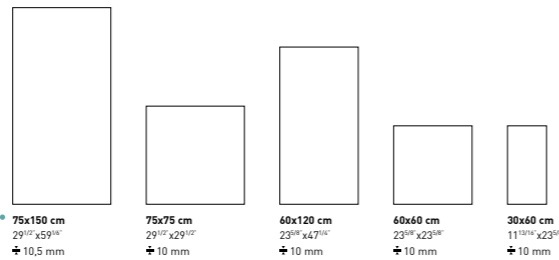

RE\_SOLUTION | CONCRETE EFFECT

## Re\_Solution

### Blanc

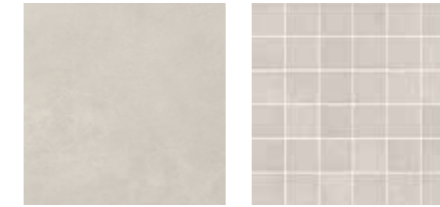

R619 75x150 Rett  
R61H 75x75 Rett  
R61P 75x75 Strutt Rett  
R61L 75x75 Brill Rett  
R6YA 60x120 Rett  
R6YV 60x60 Rett  
R6YZ 60x60 Brill Rett  
R6Z1 30x60 Rett  
R6YK 30x60 Brill Rett

R6RD 30x30 Mosaico

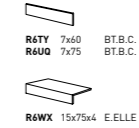

### Linen

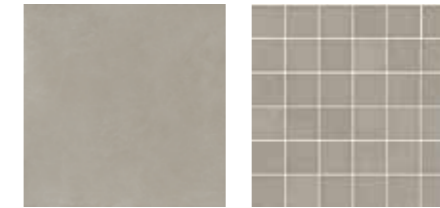

R61C 75x150 Rett  
R61J 75x75 Rett  
R61O 75x75 Strutt Rett  
R61N 75x75 Brill Rett  
R61V 60x120 Rett  
R61W 60x60 Rett  
R61I 60x60 Brill Rett  
R622 30x60 Rett  
R61L 30x60 Brill Rett

R6RE 30x30 Mosaico

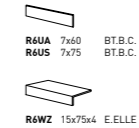

### Greige

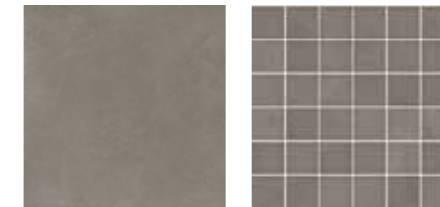

R61D 75x150 Rett  
R61K 75x75 Rett  
R61R 75x75 Strutt Rett  
R61Q 75x75 Brill Rett  
R61Y 60x120 Rett  
R61X 60x60 Rett  
R61Z 60x60 Brill Rett  
R6Z3 30x60 Rett  
R61M 30x60 Brill Rett

R6RF 30x30 Mosaico

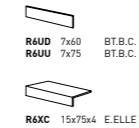

**colore**  
colour / farbe / couleur / color / цвет

**codice**  
code / artikel-nummer / code / código / код

**formato**  
size / format / format / formato / формат

**articolo**  
article / artikel / article / articulo / артикул

**pezzi speciali**  
trims / spezialteile / pièces spéciales / piezas especiales / специальные изделия

RE\_SOLUTION | CONCRETE EFFECT

### NOTE / NOTES / ANMERKUNGEN / REMARQUES / NOTAS / ПРИМЕЧАНИЯ

info tecniche riportate a chiusura di ogni collezione / technical info is provided at the end of each collection / Technische Daten am Schluss der einzelnen Kollektionen / données techniques indiquées à la fin de chaque collection / información técnica referida al final de cada colección / техническая информация приводится в конце каждой коллекции

gli spessori sono espressi in mm / thicknesses are in mm / Stärkeangaben in mm / les épaisseurs sont exprimées en mm / los grososres se expresan en mm / толщина выражена в мм

# Legenda

legend / legende / legende / leyenda / условные знаки

<b>A.E.</b>	angolo esterno outside corner außenwinkel angle sortant ángulo exterior внешний угол	<b>B.T.S.</b>	battistraccio concave skirting tile hohlkehlfliese gorge horizontale zócalo плитка со встроенным плинтусом	<b>FR.</b>	freccia interlocking tile hohlkehlfliese pfeil freccia collee flecha мозаичное украшение на сетке	<b>P.C.</b>	punto colla chequered tile punktgeklebt point de colle punto cola точка нанесения клея	<b>SP.SGU.</b>	spigolo sguscia cove base external corner kehlssockel-aussenecken plinthe a talon angle sortant esquina escocia наружный угол плинтуса с загибом вверх
<b>A.I.</b>	angolo interno inside corner innenwinkel angle rentrant ángulo interior внутренний угол	<b>C.</b>	copribordo edge cover / v-cap randfliese moulure de finition cubreborde бортовая плитка	<b>GR.</b>	gradone step linear tile laufende stufe nez de marche lineaire peldano плитка для края ступеньки с загибом	<b>R.</b>	raccordo cove base aussenecken sockel raccord enlace соединительный элемент	<b>T.</b>	tozzetto dot tile einlegestück cabochon taco вставка
<b>AL.</b>	alzata high skirting tile sockelleiste f. Wandfliesen plinthe haute zócalo высокий плинтус	<b>C.ANG.</b>	copribordo angolare edge cover angle / v-cap corner randecke moulure de finition angle sortant cubreborde angular угловая бортовая плитка	<b>GR.ANG.</b>	gradone angolare step corner tile winkelstufe nez de marche d'angle peldano angular угловая плитка для края ступеньки с загибом	<b>S.</b>	sigaro cigar tile sigaro-schmale bordüre cigare sigaro сигара	<b>TO.</b>	torello round end piece torello torello torello угловой загиб
<b>AN.</b>	angolo internal corner ecke angle rentrant angulo угол	<b>CN.E.</b>	canaletta esterna external channel / bead ausserinne caniveau exterieur media caña externa наружный канал	<b>L.</b>	listello edging tile leiste listel listelo бордюр	<b>SC.</b>	scalino stairtread stufe marche escalón плитка для края ступеньки	<b>U.</b>	unghia interna internal combination piece onklet / beak innenecken zur rinnleiste angle rentrant encuentro escocia внутренний угол
<b>AN.AL.</b>	angolo alzata high skirting tile corner außenecke f. Sockelleiste angle plinthe haute ángulo zócalo высокий угол	<b>CN.I.</b>	canaletta interna internal channel innenrinne caniveau interieur media caña interna внутренний канал	<b>LO.</b>	london london london london лондон	<b>SP.</b>	spigolo external corner aussenecken angle sortant esquina плинтус с загибом вверх (внутренний угол)	<b>UE.</b>	unghia esterna external combination piece onklet / beak aussenecken zur rinnleiste angle exterieur escocia externo наружный угол
<b>AN.L.</b>	angolo listello edging tile internal corner leistenecke listel angle rentrant angulo listelo угол бордюра	<b>C4</b>	composizione 4 pezzi 4-pcs composition vierteiliges bild composition 4 pieces composición 4 piezas композиция из 4 деталей	<b>LO.C.</b>	london/copribordo london/edge cover london/randfliese london/moulure de finition london/cubreborde лондон/угловая бортовая плитка	<b>SP.EST.</b>	spigolo esterno external corner aussenecke angle exterieur esquina externo наружный угол	<b>Z.</b>	zoccolo round top hohlkehl sockel plinthe a gorge zócalo плинтус
<b>BT.</b>	battiscopa skirting sockel plinthe rodapie плинтус простой	<b>E.ELLE</b>	elemento ad elle L-tile schenkelplatte élément en L elemento en L Г-образный элемент	<b>MT.C.</b>	matita copribordo edging pencil tore randleiste moldura cubrecantos бордюр-карандаш	<b>SP.LO.</b>	spigolo london london corner london aussenecken london angle sortant esquina london наружный угол лондон		
<b>BT.B.C.</b>	battiscopa becco civetta coved skirting tile sockelleiste mit halbrundstab plinthe à bord rond rodapié canto romo плинтус с закругленным краем	<b>F.</b>	fascia border tile bordüre frise decoree senefa полоса	<b>P.</b>	piede stop and coin aussenecken zur rinnleiste angle sortant pala de elefante подошва	<b>SP.S.</b>	spigolo sigaro cigar tile external corner sigaro-aussenecken cigare angle sortant esquina sigaro наружный угол сигары		



## Simbologia

key to symbols / symbole / symbologie / simbología / символы



pavimento matt  
matt flooring  
matter Bodenbelag  
revêtement de sol mat  
pavimento mate  
матовая напольная плитка



rivestimento matt  
matt wall tiling  
matte Wandverkleidung  
revêtement de mur mat  
revestimiento mate  
матовая облицовочная плитка



pavimento semimatt  
semimatt flooring  
halbmatter Bodenbelag  
revêtement de sol semi-mat  
pavimento semimate  
полуматовая напольная плитка



rivestimento semimatt  
semimatt wall tiling  
halbmatter Wandverkleidung  
revêtement de mur semi-mat  
revestimiento semimate  
полуматовая облицовочная плитка



pavimento lucido  
glossy flooring  
glänzender Bodenbelag  
revêtement de sol lustré  
pavimento brillante  
блестящая напольная плитка



rivestimento lucido  
glossy wall tiling  
glänzender Wandverkleidung  
revêtement de mur lustré  
revestimiento brillante  
блестящая облицовочная плитка

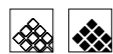

rivestimenti in pasta bianca/rossa  
white/red body wall tiles  
Wandfliesen aus weissem Ton/  
Rotem Scherben revêtements en pâte  
blanche/rouge revestimiento en pasta  
blanca/roja облицовка из белой/  
плитка для стен на красной основе



rivestimenti su supporto vetroso  
mosaic glass wall tiles  
Glasmosaik-Wandfliesen  
mosaïques en pâte de verre  
mosaicos en pasta vitrea  
облицовочная плитка на  
стекловидной основе



spessore sottile  
slim thickness  
Geringe Stärke  
épaisseur fine  
espesor fino  
тонкий



extra spessore 20 mm  
extra thickness 20 mm  
überstärke 20 mm  
épaisseur extra 20 mm  
grosor extra de 20 mm  
увеличенная толщина 20 mm



ingelivo/gelivo  
frostproof/non-frostproof  
frostbeständig/frostempfindlich  
ingélif/gélif  
resistente a la helada/disgregable  
por helada  
морозостойкий/неморозостойкий



monocottura  
single firing  
einmalbrand  
monocuisson  
monococción  
плитка двукратного обжига



superficie naturale/matt  
natural/matt surface  
natürliche/matte Oberfläche  
surface naturelle/mate  
superficie natural/mate  
натуральная/мадовая поверхность



superficie semi-matt  
semi-matt surface  
halbmatte Oberfläche  
surface mi-mate  
superficie semimate  
полуматовая поверхность



superficie glossy  
glossy surface  
glossy Oberfläche  
surface glossy  
superficie glossy  
полированная поверхность



superficie outdoor  
outdoor surface  
Außenbelags  
surface outdoor  
superficie exterior  
наружных пространств



pezzi  
pieces  
Stücke  
pièces  
piezas  
штуки



scatole  
box  
Karton  
boite  
caja  
коробки



m<sup>2</sup>  
sq.mt.  
qm  
mq  
m<sup>2</sup>



KG  
peso  
weight  
Gewicht  
poids  
kg  
вес



spessore  
thickness  
Stärke  
épaisseur  
espesor  
толщина



resistenza all'abrasione profonda  
resistance to deep abrasion  
tiefenabriebfestigkeit  
résistance à l'abrasion profonde  
resistencia a la abrasión profunda  
устойчивость к глубокому истиранию



R9

DIN 51130  
BGR 181



C

DIN 51097  
GUV 26.17

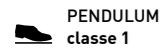

PENDULUM  
classe 1

ENV 12633  
BOE N°74 DEL 2006

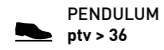

PENDULUM  
ptv > 36

BSEN 13036-4: 2011

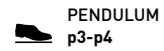

PENDULUM  
p3-p4

AS 4586-2013-Appendix A



BCR  
μ > 0,40

D.M. N°236 14/6/1989

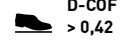

D-COF  
> 0,42

ANSI 137.1: 8012

resistenza allo scivolamento  
skid resistance  
Rutschfestigkeit  
résistance à la glissance  
resistencia al deslizamiento  
сопротивление скольжению

I PTV dichiarati a catalogo sono determinati utilizzando lo slider 96 /  
The PTVs stated in the catalogue are determined using slider 96 / Die im Katalog  
ausgewiesenen PTV-Werte wurden unter Verwendung des Gleiters 96 ermittelt /  
Les PTV déclarés dans le catalogue ont été déterminés avec le patin 96 /  
Los PTV declarados en el catálogo se han determinado utilizando la zapata  
de dureza 96 / Заявленные в каталоге значения маятникового теста (PTV)  
определяются с использованием слайдера 96

## Tecnologie

technologies / technologien / technologies / tecnologías / технологии



Le piastrelle realizzate con questa nuova tecnologia sono caratterizzate da un'elevata resistenza allo scivolamento e da una superficie morbida al tatto e facile da pulire, data l'assenza di ruvidità superficiale / The tiles produced using this new technology have a high degree of slip resistance and a surface which is soft to the touch and easy to clean, since it has no superficial roughness / Les carreaux utilisant cette nouvelle technologie de production se distinguent par une très grande résistance à la glissance et par une surface douce au toucher et facile à nettoyer puisqu'elle ne présente aucune rugosité / Mit dieser neuen Technologie hergestellte Fliesen zeichnen sich durch eine hohe Rutschhemmung, eine weiche Haptik und eine einfache Reinigung aufgrund der fehlenden Oberflächenrauheit aus / Los azulejos fabricados aplicando esta nueva tecnología se caracterizan por su elevada resistencia al deslizamiento y por presentar una superficie suave al tacto y fácil de limpiar, dada la nula aspereza de su superficie / Произведенная по этой новой технологии плитка обладает высокой стойкостью к скольжению и мягкой на ощупь, легко очищаемой поверхностью, что обеспечивается отсутствием шероховатости на поверхности



Prodotto ad alto contenuto tecnico caratterizzato dall'inclusione di scaglie a tutta massa con aspetto estremamente naturale / High-tech product with through-body inclusion of chips giving an extremely natural appearance / Produit à forte valeur technique caractérisé par l'incorporation incorporation dans la masse d'éclats de matières et par un aspect extrêmement naturel / Hochtechnologisches Erzeugnis mit in den Scherben eingeschlossenen Körnungen von äußerst natürlichem Aussehen / Producto de alto contenido técnico caracterizado por la inclusión de esquirlas en toda la masa con un aspecto extremadamente natural / Изделие с высоким технологическим содержанием, характеризующееся включением крошек по всей толщине, что придает ему очень натуральный вид



Tecnologia digitale e struttura materica ad alta definizione / Digital technology and high-definition tactile structure / Technologie numérique et effet de matière en haute définition / High-Definition-Digitaldruck und-Materialtextur / Tecnología digital y estructura matérica de alta definición / Цифровая технология и фактурная структура высокого разрешения



CleanOut è la tecnologia antimicrobica per pavimenti e rivestimenti in ceramica capace di inibire la crescita e la riproduzione di microrganismi patogeni, come batteri, muffe e funghi, riducendone la carica batterica fino al 99,9% e neutralizzando i cattivi odori / CleanOut is the antimicrobe technology for ceramic floor and wall coverings that inhibits the growth and reproduction of pathogen microorganisms, such as bacteria and fungi, reducing bacterial load by up to 99.9% and neutralising unpleasant smells / CleanOut steht für eine antimikrobielle Technologie für Boden- und Wandbelägen aus Keramik, die Wachstum und Vermehrung von schädlichen Mikroorganismen wie Bakterien und Pilzen entgegenwirkt, die Bakterienlast um bis zu 99,9 % reduziert und schlechte Gerüche neutralisiert / CleanOut, la technologie antimicrobienne destinée aux revêtements de sols et de murs en céramique, inhibe la croissance et la reproduction de micro-organismes pathogènes, tels que les bactéries et les champignons, dont elle réduit la charge bactérienne jusqu'à 99,9 % et neutralise les mauvaises odeurs / CleanOut es la tecnología antimicrobiana para pavimentos y revestimientos de cerámica capaz de inhibir el crecimiento y la reproducción de microorganismos patógenos, como bacterias y hongos, reduciendo su carga bacteriana hasta el 99,9% y neutralizando los malos olores / CleanOut - это технология антимикробной защиты для керамических полов и облицовки, способная предотвращать рост и размножение патогенных микроорганизмов, таких как бактерии и грибки, снижая их количество на 99,9% и нейтрализуя неприятные запахи

## Variazioni cromatiche

colour variations / farbvariationen / variations chromatiques / variaciones cromáticas / варианты оттенка



ASPETTO UNIFORME / UNIFORM APPEARANCE / EINHEITLICHES AUSSEHEN / АСПЕКТ УНИФОРМЕ / АСПЕКТ УНИФОРМЕ / ОДНОРОДНЫЙ ВИД

Colore uniforme, le differenze tra piastrelle della stessa produzione sono minime / Uniform colour with only minimal differences between tiles in the same production run / Einheitliche Farbe; die Unterschiede zwischen den Fliesen der gleichen Produktionscharge sind minimal / Couleur uniforme, différences minimales entre les carreaux du même lot de production / Color uniforme, las diferencias entre los azulejos de un mismo lote de producción son mínimas / Однородный цвет, разница между плитками одной партии минимальна



MODERATA VARIAZIONE / MODERATE VARIATION / MÄSSIGE VARIATION / VARIATION MODÉRÉE / VARIACIÓN MODERADA / СРЕДНИЕ ОТЛИЧИЯ

Significativa variazione di aspetto superficiale, grafica e colore da piastrella a piastrella e all'interno della stessa piastrella. Si consiglia di visionare la gamma cromatica prima della selezione del materiale / Significant variation in texture, pattern and colour from tile to tile within the same production run. The colour range should be viewed before selecting the material / Bedeutende Variation in Aussehen, Struktur und Farbe von Fliese zu Fliese und in ein und derselben Fliese. Es wird empfohlen, das Farbsortiment vor der Auswahl des Materials zu prüfen / Variation significative au niveau de l'aspect, de la fantaisie et de la couleur entre les carreaux et au sein d'un même carreau. Il est recommandé de consulter la gamme des couleurs avant de sélectionner le matériel / Variación considerable en el aspecto superficial, los motivos y el color entre un azulejo y otro y dentro del propio azulejo. Es aconsejable visualizar la gama cromática antes de seleccionar el material / Значительные отличия вида поверхности, графики и цвета у разных плиток и на одной и той же плитке. Перед отбором материала рекомендуется посмотреть цветовую гамму



LIEVE VARIAZIONE / SLIGHT VARIATION / GERINGE VARIATION / VARIATION LÉGÈRE / VARIACIÓN LEVE / ЛЕГКИЕ ОТЛИЧИЯ

Apprezzabili differenze nell'aspetto di superficie e grafica all'interno della stessa produzione / Clearly distinguishable differences in texture and pattern within the same production run / Auffällige Unterschiede in Aussehen und Struktur innerhalb der gleichen Produktionscharge / Différences visibles au niveau de l'aspect et de la fantaisie entre les carreaux du même lot de production / Diferencias visibles en el aspecto de la superficie y los motivos dentro de un mismo lote de producción / Заметные отличия вида поверхности и графики в одной и той же партии



SOSTANZIALE-RANDOM / SUBSTANTIAL-RANDOM VARIATION / STARK-ZUFÄLLIG / VARIATION IMPORTANTE-RANDOM / SUSTANCIAL/ALEATORIA / СУЩЕСТВЕННЫЕ ОТЛИЧИЯ-ПРОИЗВОЛЬНЫЙ ЦВЕТ

Variazioni irregolari da piastrella a piastrella. Una piastrella può differire totalmente nell'aspetto superficiale e colore da un'altra. Si consiglia di visionare la gamma cromatica prima della selezione del materiale / Random differences from tile to tile. One tile may have totally different texture and colour from another. The colour range should be viewed before selecting the material / Wesentliche Variationen von Fliese zu Fliese. Eine Fliese kann sich in Aussehen und Farbe komplett von einer anderen unterscheiden. Es wird empfohlen, das Farbsortiment vor der Auswahl des Materials zu prüfen / Variations irrégulières entre les carreaux. L'aspect et la couleur peuvent être complètement différents d'un carreau à l'autre. Il est recommandé de consulter la gamme des couleurs avant de sélectionner le matériel / Variaciones irregulares entre un azulejo y otro. Un azulejo puede ser completamente diferente de otro en el aspecto superficial y el color. Es aconsejable visualizar la gama cromática antes de seleccionar el material / Неоднородные изменения на разных плитках. Каждая плитка может полностью отличаться по виду поверхности и цвету от другой. Перед отбором материала рекомендуется посмотреть цветовую гамму

Per le collezioni con grado di stonalizzazione V2, V3 e V4 si raccomanda di scegliere le piastrelle da più scatole, in modo da garantire una maggiore varietà ed alternanza cromatica e grafica, ottenendo così un maggior effetto naturale / For collections with V2, V3 and V4 shade variation, tiles should be taken from more than one box at a time to guarantee a greater variety and alternation of colouring and patterns, for a more natural effect / Für die Kollektionen mit den Schattierungen V2, V3 und V4 wird empfohlen, die Fliesen aus verschiedenen Kartons zu mischen, um eine größere Farben- und Strukturvielfalt zu erzielen und die natürliche Wirkung zu verstärken / Pour les collections présentant un degré de variation de nuance V2, V3 et V4, il est recommandé de choisir des carreaux provenant de différentes boîtes, afin de garantir plus de variété et une meilleure alternance des motifs et des couleurs, ce qui permet ainsi d'obtenir un effet naturel plus prononcé / En las colecciones que presenten grados de destonificación V2, V3 y V4, se recomienda tomar azulejos de varias cajas para garantizar una mayor variedad y alternancia cromática y gráfica y así conseguir un mayor efecto natural / Для коллекций с отличием тона V2, V3 и V4 рекомендуется выбирать плитку из нескольких коробок, чтобы обеспечить наибольшее разнообразие и чередование цветов и графики, получая тем самым наиболее выраженный натуральный эффект

INCANTO & MAIORA VARIAZIONI / VARIATIONS / VARIATIONEN / VARIATIONS / VARIACIONES / ВАРИАНТЫ

Le immagini riportate rappresentano tutte le diverse grafiche del prodotto che vengono realizzate in successione sulla linea di produzione per ogni codice. Il codice prodotto è univoco: non è quindi possibile scegliere le grafiche e garantire la presenza di tutte le facce nella preparazione del materiale / The images shown illustrate the different product patterns manufactured in succession on the production line for each article. Every product code is unique: therefore, it is not possible to choose the patterns or guarantee that every tile surface will be included when the material is prepared / Les images reproduisent les différentes textures graphiques du produit, réalisées l'une à la suite de l'autre sur la ligne de production pour chaque code. Le code produit est univoque : il n'est donc pas possible de choisir les textures graphiques et de garantir la présence de toutes les variantes dans la préparation du matériau / Die Bilder zeigen die unterschiedlichen Materialzeichnungen des Produktes, die in der Produktionslinie für jeden Code nacheinander hergestellt werden. Es handelt sich um einen einheitlichen Produktcode: Aus diesem Grund ist es nicht möglich, die Materialzeichnungen auszuwählen und bei der Vorbereitung des Materials zu gewährleisten, dass alle Oberflächen vorhanden sind / Las imágenes presentadas muestran los diversos diseños gráficos del producto que se fabrican en serie en la línea de producción en referencia a cada código. El código del producto es unívoco: esto significa que no se pueden elegir los diseños gráficos y garantizar la presencia de todas las caras en la preparación del material / На изображениях приводится все разнообразие графики изделий, которая выпускается на производственной линии в последовательности для каждого кода. Код изделия является единым, следовательно, нельзя выбирать графику и гарантировать наличие всех вариантов при подготовке материала

## Destinazioni d'uso

intended uses / anwendungsbereichen / champs d'application / usos previstos / назначение

## D

Materiali consigliati solo per bagni e camere da letto di abitazioni; ogni abrasione deve essere evitata / Tiles suitable only for bathrooms and bedrooms; any type of abrasion must be avoided / Nur für Bäder und Schlafzimmer des Wohnbereichs empfohlen; jeder Abrieb muss vermieden werden / Carreaux conseillés uniquement pour salles de bains et chambres à coucher; éviter tout type d'abrasion / Materiales aconsejados solamente para baños y dormitorios de viviendas; se debe evitar toda abrasión / Материалы рекомендуются только для ваннных комнат и спален жилых помещений. Следует избегать какого бы то ни было абразивного воздействия

## F

Materiali consigliati per qualsiasi locale di un'abitazione che non abbia collegamenti diretti con l'esterno o accessi non protetti da zerbini. Medie sollecitazioni all'abrasione / Tiles suitable for any room of a house without direct access from the outside or access not protected by doormats. Mean stress abrasive wear / Für alle Räume des Wohnbereichs empfohlen, zu denen man keinen direkten Zutritt von außen hat oder welche nicht durch Fußteppiche abgegrenzt sind. Mittlere Abriebbeanspruchung / Matériaux conseillés pour toutes les pièces d'une maison qui n'a pas d'accès directs par l'extérieur ou non protégés par des paillasons. Abrasion sous contraintes moyennes / Materiales aconsejados para cualquier habitación de una vivienda sin accesos directos desde el exterior o accesos no protegidos por felpudos.Esfuerzos medianos por abrasión / Материалы рекомендованы для любых жилых помещений, не имеющих прямого выхода на улицу или же доступа без входных ковриков. Среднее абразивное воздействие

## H

Materiali consigliati per sollecitazioni all'abrasione relativamente forti in ambienti anche non protetti da agenti graffianti / Materials recommended for relatively heavy abrasion levels, also in premises not protected against abrasive substances / Empfohlen für starke Abriebbeanspruchungen in Bereichen auch ohne Kratzschutzbehandlung / Matériaux recommandés pour des locaux soumis à des fortes contraintes d'abrasion, même non protégés contre les agents abrasifs / Materiales recomendados para soportar esfuerzos de abrasión relativamente intensos incluso en espacios no protegidos frente a agentes abrasivos / Материалы рекомендованы для относительно сильного абразивного воздействия, в том числе в помещениях, не защищенных от царапающих элементов

## E

Materiali consigliati per tutti i locali di un'abitazione, con esclusione dell'ingresso e della cucina; deboli sollecitazioni all'abrasione / Tiles suitable for all rooms of a house except the entrance hall and the kitchen; low stress abrasive wear / Für alle Räume des Wohnbereichs empfohlen, mit Ausschluss von Dielen und Küchen; leichte Abriebbeanspruchung / Carreaux conseillés pour toutes les pièces d'une maison, excepté le vestibule et la cuisine; abrasion sous contraintes faibles / Materiales aconsejados para todas las habitaciones de una vivienda excluyendo el vestíbulo y la cocina; atenuada exposición a la abrasión / Материалы рекомендованы для любых жилых помещений, кроме прихожей и кухни. Небольшое абразивное воздействие

## G

Materiali consigliati per locali sottoposti a sollecitazioni all'abrasione medio pesanti come: case individuali, commerciale leggero / Materials recommended for premises with medium-heavy abrasion levels, such as: detached homes, light-traffic commercial premises / Empfohlen für Räume mit mittelschwerer Abriebbeanspruchung wie: Einfamilienhäuser, leicht beanspruchte Gewerbebereiche / Matériaux recommandés pour des locaux soumis à des contraintes d'abrasion moyennes et fortes comme : maisons particulières, espaces commerciaux soumis à un trafic léger, etc. / Materiales recomendados para locales sometidos a esfuerzos de abrasión medio-pesados, como casas unifamiliares y locales comerciales de tráfico ligero / Материалы рекомендованы для использования в частных домах и коммерческих помещениях, подверженных средне-сильному абразивному воздействию

# Pezzi speciali

trims / spezialteile / pièces spéciales / piezas especiales / специальные изделия

## Gradoni e scalini

large and small steps / stufenplatten und treppenplatten / marches larges et marches / escalones y peldaños / ступени с загибом и без

### A

gradone lineare con torelo applicato / straight step with added bullnose / stufenplatte gerade mit angesetzter florentiner kante / large marche droite avec bord arrondi / escalón lineal con canto redondeado aplicado / загибающаяся линейная ступень с наложенным внешним углом

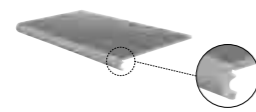

### B

gradone lineare tagliato ed assemblato / two-piece straight step / stufenplatte gerade geschnitten und zusammengesetzt / large marche droite coupée et assemblée / escalón lineal cortado y montado / собранная загибающаяся линейная ступень со срезом

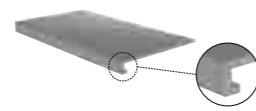

### C

gradone lineare monolitico / one-piece straight step-tread tile / stufenplatte gerade, einteilig / nez de marche monolithique / peldaño ingletado lineal monolitico / линейная монолитная ступень

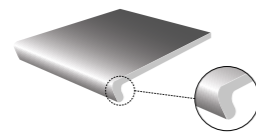

### D

Gradone bordo toro non smaltato / Unglazed bullnose step / Unglasierte Rundstab-Stufenplatte / Marche avec bord arrondi non émaillé / Peldaño ingletado de canto redondo no esmaltado / Неглазурованная ступень с закругленной кромкой

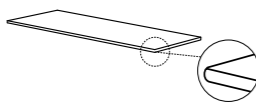

### E

scalino becco civetta smaltato con righe incise / glazed coved edge step with sunken grooves / treppenplatte mit glasierter viertelstabkante und eingefrästen rillen / large marche avec bord rond émaillé et bandes gravées / peldaño de canto roma esmaltado con rayas grabadas / ступень с закругленным глазурованным краем с нарезными полосами

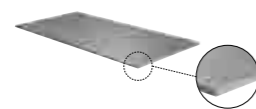

### F

scalino con righe in corindone / step tile with carborundum strips / treppenplatte mit aufgesetzten Korundprofilen / large marche avec bandes en corindon / peldaño con rayas de corindón / ступень с полосами из корунда

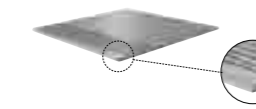

## Angolari

corners / eckplatten / pièces d'angle / angulares / угловые элементы

### G

angolare tagliato ed assemblato SX / L two-piece corner / Eckplatte geschnitten und zusammengesetzt li / pièce d'angle coupée et assemblée Gauche / angular cortado y montado izqda / собранный угловой элемент лев со срезом

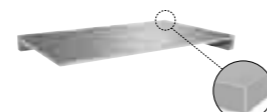

angolare tagliato ed assemblato DX / R two-piece corner / Eckplatte geschnitten und zusammengesetzt re / pièce d'angle coupée et assemblée Droite / angular cortado y montado dcha / собранный угловой элемент прав со срезом

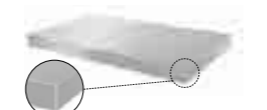

### H

angolare monolitico / one-piece corner tile / eckstück, einteilig / pièce d'angle monolithique / pieza angular monolitica / монолитный угол

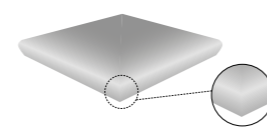

## Elementi ad Elle

corners / eckplatten / pièces d'angle / angulares / угловые элементы

### I

elemento ad elle monolitico piegato / one-piece bent l-tile / schenkelplatte einteilig, gebogen / élément en l monolithique cintré / elemento en forma de "l" monolitico doblado / монолитный гнутый г-образный элемент

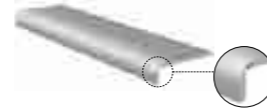

### L

elemento ad elle tagliato ed assemblato / two-piece l-tile / schenkelplatte geschnitten und zusammengesetzt / élément en l coupé et assemblé / elemento en forma de "l" cortado y montado / собранный г-образный элемент со срезом

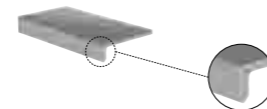

### M

elemento ad elle monolitico pressato / one-piece pressed L-tile / schenkelplatte einteilig, gepresst / élément en L monolithique pressé / elemento en forma de "l" monolitico prensado / монолитный прессованный элемент

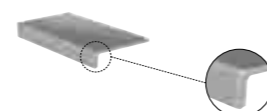

Collezione	A	B	C	D	E	F	G	H	I	L	M
Concept		✓									
Concept XT20				✓						✓	
Creek										✓	
Emilia											✓
Galassia						✓					
Epoca			✓					✓			✓
Eterna		✓								✓	
Patina XT20				✓							
Rewind		✓									
Realstone_Cardoso										✓	
Realstone_Jerusalem										✓	
Realstone_Jerusalem XT20				✓							
Realstone_Lunar										✓	
Realstone_Quarzite										✓	
Realstone_Navigli										✓	
Realstone_PietrAntica		✓									
Realstone_PietrAntica XT20				✓							
Realstone_Rain										✓	
Realstone_Slate										✓	
Realstone_Slate XT20				✓							
Replace										✓	
Re_Solution										✓	
Rewind XT20				✓							
Rock Ground										✓	
Roots		✓								✓	
Season										✓	
Stoneway_Ardesia										✓	
Stoneway_Barge Antica						✓				✓	
Stoneway_Porfido										✓	
Stratford										✓	
Stratford XT20				✓							
Woodliving		✓									
Woodliving XT20				✓							
Woodmania XT20				✓							
Woodsense XT20				✓							
Woodtale		✓									
Woodtale XT20				✓							

## Certificazioni

certifications / zertifizierungen / certifications / certificaciones / сертификации



L'Azienda assolve agli obblighi sulla marcatura CE rendendo disponibili le informazioni sul proprio sito web: [www.ragno.it](http://www.ragno.it)

Conformément aux dispositions en matière de marquage CE, l'entreprise publie les informations requises sur son site Web: [www.ragno.it](http://www.ragno.it)

The Company fulfils its CE marking obligations through publication of all relative information on its website: [www.ragno.it](http://www.ragno.it)

La empresa cumple con las obligaciones del sello CE ofreciendo información en su página web: [www.ragno.it](http://www.ragno.it)

Die Firma erfüllt die Verpflichtungen für das CE-Kennzeichnung und stellt die Informationen auf der eigenen Internetseite [www.ragno.it](http://www.ragno.it) bereit

Компания выполняет свои обязанности по маркировке CE, предоставляя информацию на ее сайте интернете: [www.ragno.it](http://www.ragno.it)



Ragno è un brand di Marazzi Group S.r.l. che è membro del Green Building Council Italia, associazione che promuove la cultura dell'edilizia sostenibile energeticamente efficiente, rispettosa dell'ambiente contribuendo a migliorare la qualità della vita dei cittadini attraverso lo standard di certificazione Leed®.

Ragno is a brand of Marazzi Group S.r.l. which is a member of the Green Building Council Italia, an association that promotes sustainable energy-efficient building practices, which are environmentally friendly and help improve the quality of life through LEED® certification standards.

Ragno ist eine Marke der Marazzi Group S.r.l., die Mitglied des Green Building Council Italien ist, ein Verband, der die Kultur des nachhaltigen und energieeffizienten, umweltverträglichen Bauens fördert, indem zur Lebensqualität der Mitmenschen durch die Zertifizierung nach den LEED®-Standards beigetragen wird.

Ragno является брендом компани Marazzi Group S.r.l., которая входит в Green Building Council Italia, - ассоциацию, продвигающую культуру экоустойчивого энергосберегающего строительства, щадящего окружающую среду. Соблюдение сертификационных стандартов LEED® способствует улучшению качества жизни людей.



La certificazione francese QB UPEC offre all'utente una garanzia: assicura che i prodotti consegnati, recanti i loghi QB e UPEC, siano conformi a quanto previsto dalla norma NF EN 14411 secondo le presenti regole di certificazione e che tali prodotti possiedano le caratteristiche d'uso definite nel disciplinare CSTB «Specifiche tecniche per la classificazione UPEC dei rivestimenti ceramici per pavimenti». Le quattro lettere indicano rispettivamente: U: resistenza all'usura da calpestio P: resistenza meccanica agli spostamenti di oggetti mobili e fissi E: comportamento in presenza di acqua C: resistenza agli agenti chimici correnti La lista completa e aggiornata dei prodotti certificati è visionabile sul sito [www.cstb.fr](http://www.cstb.fr). Per qualsiasi ulteriore informazione contattare Marazzi Group.

French QB UPEC certification provides the user with a quality guarantee: it confirms that the products delivered, marked with the QB and UPEC logos, comply with the prerequisites of the NF EN 14411 standard in accordance with the current certification rules and that they have the performance characteristics specified in the CSTB (Centre Scientifique et Technique du Bâtiment - Scientific and Technical Centre for Building) "Technical Specifications for the UPEC Classification of Ceramic Floor Coverings". The four letters refer to: U: resistance to foot traffic wear P: mechanical resistance to the shifting of movable and fixed objects E: resistance to water C: resistance to commonly used chemicals The full, up-to-date list of certified products can be viewed at [www.cstb.fr](http://www.cstb.fr). Please contact the Marazzi Group for any further information.

Die französische UPEC Zertifizierung garantiert dem Endkunden, dass die mit dem Logo QB-UPEC gekennzeichneten Artikel den Bestimmungen der Norm NF EN 14411 gemäß den Zertifizierungsregelungen entsprechen und die Gebrauchseigenschaften besitzen, die vom Merkblatt des CSTB (Centre Scientifique et Technique du Bâtiment - Wissenschaftliches und technisches Zentrum für Bauwesen) „Technische Vorschriften für die UPEC Klassifizierung von keramischen Bodenbelägen“ festgelegt sind. Die vier Buchstaben bezeichnen jeweils: U: Trittschallbedingte Abnutzung P: Eindrucksuren durch Mobiliar und sonstige fest installierte oder mobile Einrichtungen (Objekte) E: Verhalten gegenüber Wasser C: Verhalten gegenüber Chemikalien Die komplette und aktualisierte Liste der zertifizierten Produkte ist im Internet auf [www.cstb.fr](http://www.cstb.fr) einsehbar. Für ausführliche Informationen kontaktieren Sie bitte die Marazzi Group.

Французский сертификат QB UPEC предлагает клиенту следующую гарантию: подтверждает, что поставленная продукция, имеющая логотип QB и UPEC, соответствует нормам NF EN 14411 по существующим правилам сертификации, и что данная продукция обладает характеристиками по эксплуатации, определенными в правилах CSTB "Технические спецификации для классификации UPEC керамических материалов для настила полов". Четыре буквы сокращения обозначают: U: износостойкость при хождении P: механическая стойкость к передвижению передвижных и неподвижных предметов E: поведение при наличии воды C: стойкость к воздействию химических веществ Полный обновленный перечень сертифицированных продуктов приводится на сайте [www.cstb.fr](http://www.cstb.fr). За любой другой информацией обращайтесь в Marazzi Group.

La certification française QB UPEC représente une garantie pour l'utilisateur. En effet, elle atteste la conformité des produits marqués QB UPEC aux spécifications techniques de la norme NF EN 14411 selon les présentes règles de certification. Elle garantit également que ces produits possèdent les caractéristiques d'usage établies dans le cahier du CSTB « Revêtements de sol céramiques - Spécifications techniques pour le classement UPEC ». Les quatre lettres indiquent respectivement : U : Usure à la marche P : Résistance mécanique au déplacement d'objets mobiles et fixes E : Comportement à l'eau C : Tenue aux agents chimiques ordinaires La liste complète et à jour des produits certifiés peut être consultée sur le site [www.cstb.fr](http://www.cstb.fr). Pour tout renseignement complémentaire, veuillez contacter Marazzi Group.

La certificación francesa QB UPEC le ofrece al usuario la garantía de que los productos entregados que lleven los logotipos QB y UPEC resultan conformes con lo previsto por la norma NF EN 14411 de acuerdo con las presentes reglas de certificación y que tales productos poseen las características de uso referidas en el reglamento del CSTB (Centro Científico y Técnico de la Construcción de Francia) denominado «Especificaciones técnicas para la clasificación UPEC de revestimientos cerámicos para pavimentos». Respectivamente, las cuatro letras indican: U: resistencia a la abrasión provocada por el tránsito peatonal P: resistencia mecánica al desplazamiento de objetos móviles y fijos E: comportamiento en presencia de agua C: resistencia a los productos químicos de uso común. La lista completa y actualizada de los productos certificados se puede consultar accediendo al sitio web [www.cstb.fr](http://www.cstb.fr). Para más información pueden ponerse en contacto con Marazzi Group.



Idoneità delle piastrelle ceramiche alla posa su piedini.

Aptitude des carreaux céramiques à une mise en oeuvre sur plots.

Suitability of ceramic tiles for installation on pedestals.

Idoneidad de las baldosas cerámicas para la colocación sobre soportes.

Eignung der keramischen Fliesen zur Verlegung auf Stelzlagern.

Пригодность керамической плитки для укладки на опоры.

**Leed® Credit**  
La certificazione volontaria LEED® (Leadership in Energy and Environmental Design) è il protocollo più diffuso a livello internazionale per la bioedilizia e la progettazione sostenibile promosso da U.S Green Building Council. Il sistema di rating LEED® si struttura in 9 categorie, ciascuna delle quali è organizzata in requisiti obbligatori e crediti determinati dalle caratteristiche del progetto. Tutti i prodotti in ceramica e in gres porcellanato Ragno, grazie alla qualità ecologica dell'intero ciclo industriale di produzione, contribuiscono all'ottenimento dei crediti LEED® degli edifici, in particolare, per le aree tematiche relative a Materiali e Risorse (MR), Sito Sostenibile (SS) e Qualità Ambientale Interna (EQ).

**Crédit Leed®**  
Initiée par l'US Green Building Council, la certification volontaire LEED® (Leadership in Energy and Environmental Design) est le référentiel le plus divulgué à l'international pour la bioconstruction et pour la construction durable. Le système de rating LEED® est divisé en neuf catégories intégrant chacune des critères obligatoires et des crédits en fonction des caractéristiques du projet. En raison de la qualité écologique du cycle industriel, tous les produits en céramique et grès cérame Ragno contribuent à l'obtention des crédits LEED®, et notamment dans les catégories Matériaux et Ressources (MR), Aménagement écologique des sites (SS) et Qualité environnementale de l'air intérieur (EQ).

**Leed® Credit**  
Voluntary LEED® (Leadership in Energy and Environmental Design) certification is the most widespread international protocol for green building and sustainable architecture promoted by the U.S Green Building Council. The LEED® rating system is structured into 9 categories, each of which is organized into mandatory prerequisites and credits determined by the characteristics of the project. Thanks to the environmental quality of the entire industrial production cycle, all Ragno's ceramic and porcelain stoneware products are eligible for LEED® credits for buildings, in particular for thematic areas related to Materials and Resources (MR), Sustainable Site (SS) and Indoor Environmental Quality (EQ).

**Crédito Leed®**  
La certificación voluntaria LEED® (Leadership in Energy and Environmental Design) es el protocolo más difundido a nivel internacional para la construcción ecológica y el diseño sostenible promovido por el U.S Green Building Council. El sistema de calificación LEED® está estructurado en 9 categorías, cada una de las cuales está organizada en requisitos obligatorios y créditos determinados por las características del proyecto. Todos los productos de cerámica y gres porcelánico Ragno, gracias a la calidad ecológica de todo el ciclo industrial de producción, contribuyen a la obtención de los créditos LEED® de los edificios, en particular, para las áreas temáticas relativas a Materiales y Recursos (MR), Sitio Sostenible (SS) y Calidad Ambiental Interior (EQ).

**Leed® Punkte**  
Die freiwillige Zertifizierung nach LEED® (Leadership in Energy and Environmental Design) ist der internationale populärste Standard für nachhaltiges Planen und Bauen und wurde vom U.S Green Building Council erarbeitet. Das Checklistsensystem nach LEED® ist in neun Zertifikatgruppen gegliedert, für die jeweils obligatorische Anforderungen und Punktebewertungen ausgehend von den Projektmerkmalen gelten. Alle Produkte aus Keramik und Feinsteinzeug von Ragno tragen aufgrund der Umweltverträglichkeit ihres gesamten Fertigungsprozesses zur Erlangung von LEED® Punkten für Gebäude bei, insbesondere bezüglich der Themenfelder Materialien und Ressourcen (MR), Nachhaltige Baugelände (SS) und Komfort und Raumqualität (EQ).

**Кредиты Leed®**  
Добровольная сертификация LEED® (Leadership in Energy and Environmental Design) - это самый распространенный на международном уровне протокол для биостроительства и экологически рационального проектирования, продвигаемый U.S Green Building Council. Система рейтинга LEED® подразделяется на 9 категорий, каждая из которых предусматривает обязательные предварительные требования и кредиты, определяемые характеристиками проекта. Благодаря экологичности полного промышленного производственного цикла вся керамическая и керамогранитная продукция Ragno способствует получению кредитов LEED® для зданий, в частности, для таких тематических разделов, как: Материалы и ресурсы (MR), Место экологического строительства (SS) и Качество среды в помещениях (EQ).

# Certificazioni

certifications / zertifizierungen / certifications / certificaciones / сертификации



La Certificazione GREENGUARD GOLD garantisce che un prodotto soddisfi alcuni degli standard internazionali più rigorosi ed esaustivi in relazione alle basse emissioni di composti organici volatili (COV) in ambienti interni. Maggiori informazioni sono disponibili sul sito: <http://spot.ulprospector.com>

La certification GREENGUARD GOLD atteste qu'un produit est conforme à quelques-unes des normes les plus sévères et les plus complètes au monde en matière d'émissions dans l'air intérieur de composés organiques volatils (COV). De plus amples informations sont disponibles sur le site : <http://spot.ulprospector.com>

Abitare
A_Mano
Bistrot
Boom
Brick Glossy
Calce
Casablanca
Concept
Concept XT20
Contrasti
Creek
Eden
Epoca
Emilia
Escape
Freetime
Galassia
Gleeze
Harmony
Imperiale
Incanto
Ironstone
Maiora Marble
Maiora Concrete
Mélange
Ottocento
Patina
Patina XT20
Realstone_Argent

GREENGUARD GOLD Certification ensures that a product has met some of the world's most rigorous and comprehensive standards for low emissions of volatile organic compounds (VOCs) into indoor air. More information is available on the site: <http://spot.ulprospector.com>

La certificación GREENGUARD GOLD garantiza que un producto cumple con algunas de las normas más estrictas y exhaustivas del mundo en materia de bajas emisiones de compuestos orgánicos volátiles (COV) al aire en espacios cerrados. Se halla a disposición información más detallada en el sitio: <http://spot.ulprospector.com>

Realstone_Cardoso
Realstone_Cardoso XT20
Realstone_Jerusalem
Realstone_Jerusalem XT20
Realstone_Quarzite
Realstone_Quarzite XT20
Realstone_Lunar
Realstone_Lunar XT20
Realstone_Navigli
Realstone_Navigli XT20
Realstone_PietrAntica
Realstone_PietrAntica XT20
Realstone_Rain
Realstone_Rain XT20
Realstone_Slate
Realstone_Slate XT20
Replace
Re_Solution
Rewind
Rewind XT20
Season
Sound
Stoneway_Ardesia
Stoneway_Ardesia XT20
Stoneway_Barge Antica
Stoneway_Barge Antica XT20
Stoneway_Porfido
Stoneway_Porfido XT20
Stratford

Die GREENGUARD GOLD-Zertifizierung bescheinigt, dass ein Produkt die weltweit strengsten und umfassendsten Obergrenzen für die Emission von flüchtigen organischen Verbindungen (VOCs) in die Innenraumluft einhält. Sie auf der Internetseite: <http://spot.ulprospector.com>

То сертификат GREENGUARD GOLD гарантирует, что продукция удовлетворяет один из наиболее строгих и всеохватывающих стандартов в мире по низкому выделению летучих органических соединений в воздухе помещений. Более подробная информация доступна на сайте: <http://spot.ulprospector.com>

Stratford XT20
Studio
Touch
Woodchoice
Woodclass
Woodclassic
Woodcomfort
Woodcraft
Woodessence
Woodglam
Woodlike
Woodliving
Woodliving XT20
Woodmania
Woodmania XT20
Woodpassion
Woodplace
Woodreal
Woodshape
Woodsense
Woodsense XT20
Woodsoft
Woodstory
Woodtale
Woodtale XT20
Unitech
Unitech Wall



Ragno ha ottenuto il marchio EU Ecolabel, marchio di qualità ecologica dell'Unione Europea, che garantisce un minor consumo energetico nei processi di produzione, minori emissioni nell'aria e nell'acqua, l'utilizzo di sostanze non pericolose per l'uomo e per l'ambiente, l'utilizzo di cave con corretta gestione ambientale, una migliore informazione al consumatore e una migliore gestione dei rifiuti. Grazie a questo marchio di eccellenza, Ragno risponde ai Criteri Minimi Ambientali (CAM) previsti dagli appalti pubblici. In occasione del convegno Emas - Ecolabel di Roma dell'1 marzo 2006, a Marazzi Group è stato conferito dal Ministero dell'Ambiente e della Tutela del Territorio, uno speciale Award per il suo impegno e la sua attenzione all'ambiente. Il rispetto dell'ambiente rappresenta un impegno di fondamentale importanza per tutti, perché l'ambiente è la "casa di tutti". Le piastrelle o loro tagli rimasti dopo l'installazione sono rifiuti non pericolosi per l'ambiente e destinati al recupero. Devono essere conferiti con il codice rifiuto europeo CER 170103 (solo piastrelle) o CER 170107 (aggregati con altro materiale edile da demolizione) e possono essere recuperati come materiale per fondo stradale, materiale di riempimento in bonifiche, produzione di laterizi. Il cartone (CER 150101), il legno (CER 170201) e i materiali plastici (CER 170203) che costituiscono l'imballaggio delle piastrelle devono essere inviati al recupero come da raccolta differenziata. Per eventuali maggiori informazioni in merito all'installazione delle piastrelle è possibile contattare il servizio assistenza vendite Ragno. Maggiori informazioni sono disponibili sul sito del marchio Ecolabel: <http://www.ecolabel.eu>

Ragno a obtenu l'EU Ecolabel, le label écologique de l'Union européenne qui garantit la réduction de la consommation énergétique dans la fabrication, la diminution des émissions dans l'air et dans l'eau, l'emploi de substances non dangereuses pour l'homme et pour l'environnement, la gestion durable des carrières, une meilleure information du consommateur et une meilleure gestion des déchets. Avec ce label d'excellence, Ragno observe les critères environnementaux minimum (CAM) imposés par les marchés publics. À l'occasion de la conférence EMAS-Ecolabel du 1 mars 2006 à Rome, le Ministère de l'Environnement et de la Protection du Territoire italien a décerné à Marazzi Group une récompense spéciale pour son engagement et pour sa sensibilité à l'égard de l'environnement. L'environnement, c'est la « maison de tous » : son respect est donc un engagement d'importance capitale pour tout un chacun. Les carreaux ou les découpes en surplus au terme de la pose sont des déchets non dangereux pour l'environnement et destinés au recyclage. Ces déchets doivent être remis sous le code européen CER 170103 (céramiques uniquement) ou CER 170107 (mélanges avec d'autres déchets de construction et de démolition) et peuvent être réutilisés pour la réfection des chaussées, pour le remplissage des ouvrages d'assainissement, pour la fabrication de briques. Le carton (CER 150101), le bois (CER 170201) et les matières plastiques (CER 170203) qui constituent l'emballage des carreaux, doivent être recyclés selon les règles du tri sélectif. Pour toute information supplémentaire sur la pose des carreaux, vous pouvez contacter l'assistance commerciale Ragno. Pour plus de renseignements, veuillez visiter le site Ecolabel : <http://www.ecolabel.eu>

Ragno has obtained the EU Ecolabel, a European Union ecological quality mark that guarantees lower energy consumption in production processes, lower atmospheric and wastewater emissions, use of substances that are not dangerous for humans and the environment, use of quarries with correct environmental management, more effective consumer information and improved waste management. Thanks to this label of excellence, Ragno meets the Minimum Environmental Criteria (CAM) required for public procurement. At the EMAS - Ecolabel conference in Rome on 1 March 2006, the Italian Ministry of the Environment presented Marazzi Group with a special award for its commitment and focus on the environment. Protecting the environment is a commitment of fundamental importance for everyone, because the environment is "home to us all". The tiles or their cuts that remain after installation are waste that is non-hazardous for the environment and is designed to be recycled. They must be assigned the European waste code EWC 170103 (tiles only) or EWC 170107 (aggregated with other demolition building material) and can be recycled as a road surface material, reclaimed filling material or for brick production. The cardboard (EWC 150101), wood (EWC 170201) and plastic materials (EWC 170203) that make up the tiles' packaging must be appropriately recycled. For more information regarding installation of the tiles, contact the Ragno sales assistance service. More information is available on the Ecolabel website: <http://www.ecolabel.eu>

Ragno también ha obtenido la etiqueta EU Ecolabel, marca de calidad ecológica de la Unión Europea que certifica un menor consumo energético en los procesos de fabricación, menos emisiones al aire, menos vertidos al agua, la utilización de substancias no peligrosas para el ser humano ni para el medio ambiente, la utilización de canteras con una correcta gestión medioambiental, así como una mejor información al consumidor y una mejor gestión de los residuos. Gracias a esta etiqueta de excelencia, Ragno responde a los criterios medioambientales mínimos (CAM) previstos en las adjudicaciones de obras públicas. Con ocasión del congreso EMAS - Ecolabel de Roma del 1 de marzo de 2006, el Ministerio italiano de Medio Ambiente y Salvaguardia del Territorio le concedió a Marazzi Group un galardón especial por su compromiso y su desvelo en pro del medio ambiente. El respeto medioambiental constituye un compromiso de fundamental importancia para todos, porque el medio ambiente es la "casa de todos". Los azulejos y los fragmentos sobrantes después de las operaciones de colocación constituyen residuos no peligrosos para el medio ambiente, y son destinados al reciclaje. Tienen que eliminarse de conformidad con los códigos del catálogo europeo de residuos CER 170103 (solo azulejos) o CER 170107 (unidos a otros materiales de la construcción de demolición) y se pueden reciclar como material para la pavimentación vial, material de relleno en obras de saneamiento y para la fabricación de ladrillos. El cartón (CER 150101), la madera (CER 170201) y los materiales plásticos (CER 170203) que conforman el embalaje de los azulejos deben entregarse para su reciclaje ateniéndose a los criterios de la recogida selectiva. Para más información acerca de la colocación de los azulejos pueden ponerse en contacto con el servicio de asistencia a la venta de Ragno. Se halla a disposición información más detallada en el sitio del certificado Ecolabel: <http://www.ecolabel.eu>

Ragno wurde mit dem EU-Ecolabel, dem Europäischen Umweltzeichen, ausgezeichnet. Es bürgt für sparsamen Energieverbrauch der Herstellungsprozesse, geringere Schadstoffemissionen in Wasser und Luft, Verwendung von ungefährlichen Stoffen für Mensch und Umwelt, nachhaltige Nutzung der Abbaustätten, bessere Verbraucherinformation und optimiertes Abfallmanagement. Dank diesem Gütesiegel entspricht die Ragno den Mindestumweltkriterien (MUK) für die Vergabe öffentlicher Aufträge. Im Rahmen der EMAS - Ecolabel Tagung in Rom am 1. März 2006 wurde Marazzi Group vom italienischen Ministerium für Umwelt und Landschafts- und Meeresschutz mit einem Sonderpreis für das Engagement für Umwelt und Nachhaltigkeit ausgezeichnet. Umweltschutz ist für alle von grundlegender Bedeutung, denn die Umwelt ist das „Zuhause von allen“. Auf der Baustelle anfallende Fliesen- und Fliesenschnittreste stellen keine Belastung für die Umwelt da und sind für die Wiederverwertung bestimmt. Sie sind gemäß dem Europäischen Abfallkatalog mit dem EAV-Code 170103 (nur Fliesen) oder EAV-Code 170107 (Gemische mit anderen Baustoffen) zu entsorgen und können als Füll- oder Schüttmaterial im Wege- und Tiefbau und in der Ziegelproduktion wiederverwertet werden. Pappe (EAV-Code 150101), Holz (EAV-Code 170201) und Kunststoffe (EAV-Code 170203) der Fliesenverpackungen sind durch Getrennsammlung der Wiederverwertung zuzuführen. Für ausführliche Informationen zur Verlegung von Fliesen wenden Sie sich bitte an den Vertriebservice von Ragno. Weiterführende Informationen zum Ecolabel finden Sie im Internet auf <http://www.ecolabel.eu>

Ragno получила маркировку ЕС Ecolabel - маркировку экологического качества Евросоюза, гарантирующую наименьшее потребление энергии в производственных процессах, наименьшие выбросы в атмосферу и в воду, использование невредных веществ для человека и окружающей среды, более полное информирование потребителя и наилучший менеджмент отходов. Благодаря этой маркировке, подтверждающей совершенство, Ragno отвечает минимальным критериям по окружающей среде (CAM), предусмотренным для государственных подрядов. На конгрессе Emas - Ecolabel, проходившем в Риме 1 марта 2006 года, Министерством природы и охраны территории Италии группе Marazzi Group была присуждена специальная награда за внимание и вклад в дело защиты окружающей среды. Уважительное отношение к природе играет первостепенную роль для всех, так как окружающая среда является "нашим общим домом". Плитка и ее обрезки, оставшиеся после установки, являются неопасными для окружающей среды отходами, подлежащими повторному использованию. Они должны утилизироваться с европейским кодом отходов EWC 170103 (только плитка) или EWC 170107 (смесь с другим строительным мусором) и могут повторно использоваться для изготовления подушек в дорожном строительстве, в качестве материала для отсыпки при мелиорации, в производстве кирпича. Картон (EWC 150101), дерево (EWC 170201) и пластмасса (EWC 170203), из которых изготавливается упаковка плитки, должны сдаваться в утиль отдельно. Для получения более подробной информации по установке плитки можно обращаться в отдел реализации компании Ragno. Более подробная информация доступна на сайте, посвященном маркировке Ecolabel: <http://www.ecolabel.eu>

Serie con certificazione Ecolabel / Series with Ecolabel certification / Serien mit Ecolabel-Zertifikat / Séries certifiées Ecolabel / Series con certificación Ecolabel / Серии с сертификатом Ecolabel

Concept

# Certificazioni

certifications / zertifizierungen / certifications / certificaciones / сертификации



La certificazione CCC, introdotta nel 2002 interessa sia i prodotti di importazione che quelli di produzione cinese destinati a quel mercato. Le informazioni sulla certificazione CCC riguardano in generale la sicurezza e la salute, con particolare riferimento, nel caso delle piastrelle di ceramica, alle sole piastrelle in gres porcellanato, con un assorbimento minore o uguale allo 0,5%. La certificazione si ottiene attraverso l'intervento di istituti appositamente accreditati dalle autorità cinesi, tutti con sede in Cina.

La certification CCC, introduite en 2002, intéresse aussi bien les produits d'importation que ceux de production chinoise destinés à ce marché. Les informations sur la certification CCC concernent en général la sécurité et la santé, avec une référence toute particulière, dans le cas des carreaux en céramique, uniquement aux carreaux en grès cérame, à absorption inférieure ou égale à 0,5%. On l'obtient par l'intermédiaire d'organismes de certification et d'accréditation chinois, tous avec siège en Chine.



CCC certification, introduced in 2002, applies to products both imported to China and produced in the country for the Chinese market. Information concerning CCC certification generally relates to health and safety. In the case of ceramic tiles, reference is made specifically only to porcelain tiles having water absorption of 0.5% or less. Certification is obtained through institutions specifically accredited by the Chinese authorities, all based in China.

La certificación CCC, introducida en el 2002, concierne tanto a los productos de importación como a los de producción china destinados a ese mismo mercado. La información acerca de la certificación CCC atañe en general a la seguridad y la salud, con especial referencia, en el caso de las baldosas de cerámica, solamente a las baldosas de gres porcelánico, con una absorción inferior o igual al 0,5%. Se consigue a través de la intervención de instituciones específicamente acreditadas por las autoridades chinas, todas ellas sitas en China.

Die im Jahr 2002 eingeführte CCC-Zertifizierung betrifft sowohl in China importierte als auch in China produzierte Erzeugnisse, die für den chinesischen Markt bestimmt sind. Die Informationen über die CCC-Zertifizierung betreffen im Allgemeinen die Sicherheit und Gesundheit und im Bereich von Keramikfliesen insbesondere die Feinsteinzeugfliesen mit einer Wasseraufnahme kleiner oder gleich 0,5 %. Das Zertifizierungsverfahren erfolgt durch die von den chinesischen Behörden akkreditierten Stellen, die sämtlich ihren Geschäftssitz in China haben.

Система сертификации CCC, вступившая в действие в 2002 году, применяется как на импортную, так и на китайскую отечественную продукцию, предназначенную для китайского рынка. Вообще, сведения о сертификации CCC касаются безопасности и здоровья; в частности, в случае керамической плитки, они относятся только к плитке из гres порcelánico, с водопоглощением менее или равным 0,5%. Сертификацию осуществляют специально аккредитованные у китайских властей институты, все они располагаются в Китае.



Declare è un programma volontario di autodichiarazione che ha l'obiettivo di portare l'industria dei materiali da costruzione verso prodotti più sani e più ecologici, grazie alla comunicazione trasparente degli ingredienti. I prodotti autodichiarati di Marazzi Group sono classificati "Red List Free", ovvero non contengono ingredienti presenti nella "Red List" del Living Building Challenge:

- nessuna sostanza chimica che inquina l'ambiente
- nessuna sostanza chimica bioaccumulabile lungo la catena alimentare che possa raggiungere concentrazioni tossiche
- nessuna sostanza chimica dannosa per i lavoratori nella produzione e nell'edilizia

Contribuisce al raggiungimento dei crediti LEED

Declare est un programme d'autodéclaration volontaire dont l'objectif est de faire évoluer l'industrie des matériaux de construction vers des produits plus sains et plus écologiques grâce à une déclaration transparente des ingrédients. Les produits autodéclarés de Marazzi Group sont classés « Red List Free », ce qui signifie qu'ils ne contiennent aucun ingrédient figurant sur la liste rouge du Living Building Challenge, le programme international de certification des bâtiments durables :

- pas de produits chimiques qui polluent l'environnement
- pas de substance chimique bioaccumulable le long de la chaîne alimentaire pouvant atteindre des concentrations toxiques
- pas de produits chimiques nocifs pour les travailleurs de la production et de la construction

Le programme « declare label » contribue à l'obtention de crédits LEED



Declare is a voluntary self-declaration programme that aims to steer the building materials industry towards healthier, more eco-friendly products through transparent ingredient disclosure. Marazzi Group's self-declared products are classified as "Red List Free", i.e. they do not contain any ingredients on the Living Building Challenge "Red List":

- no chemicals that pollute the environment
- no chemicals that bio-accumulate up the food chain until they reach toxic concentrations
- no chemicals that harm construction and factory workers

The declare label program contributes to achieving LEED credits

«Declare» es un programa voluntario de autodéclaration cuyo objetivo es orientar la industria de los materiales de construcción hacia productos más sanos y ecológicos, por medio de la comunicación transparente de los ingredientes. Los productos autodéclarados por Marazzi Group se clasifican como «Red List Free», es decir, que no contienen ingredientes presentes en la lista roja o «Red List» del programa de certificación de construcción sostenible «Living Building Challenge»:

- sin sustancias químicas que contaminan el medioambiente
- sin sustancias químicas bioacumulables a lo largo de la cadena alimentaria que puedan alcanzar concentraciones tóxicas
- sin sustancias químicas nocivas para los trabajadores de la producción y la construcción

El programa "declare label" contribuye a la obtención de créditos LEED

Declare ist ein freiwilliges Eigenerklärungsprogramm, das darauf abzielt, die Baustoffbranche durch Transparenz bei der Angabe der Inhaltsstoffe zu gesundheits- und umweltfreundlicheren Produkten zu bewegen. Die mit Eigenerklärung versehenen Produkte der Marazzi Group sind als „Red-List-Free“ eingestuft, d.h. sie enthalten keine Inhaltsstoffe, die in der roten Liste der Living Building Challenge enthalten sind:

- keine Chemikalien, die schädlich für die Umwelt sind
- keine bioakkumulierbaren Chemikalien in der Lebensmittelkette, die giftige Konzentrationen erreichen können
- keine Chemikalien mit schädlichen Auswirkungen für Arbeitnehmer in der Produktion und im Baugewerbe

Das Programm „declare label“ trägt zum Erreichen von LEED-Credits bei

Declare - это программа добровольной сертификации, целью которой является подталкивание промышленности строительных материалов к выпуску более здоровой и экологичной продукции путем прозрачного указания всех ингредиентов. Продукция, на которую Marazzi Group составляет декларацию, классифицирована как "Red List Free", то есть, в ней отсутствуют ингредиенты, перечисленные в «красном списке» программы Living Building Challenge:

- полное отсутствие загрязняющих природу химических веществ
- полное отсутствие химических веществ, которые имеют тенденцию к биоаккумуляции по пищевой цепочке и могут достичь токсичной концентрации
- полное отсутствие химических веществ, наносящих вред здоровью людей во время производства и использования строительных материалов

Позволяет получить баллы по системе LEED

# Certificazioni

certifications / zertifizierungen / certifications / certificaciones / сертификации

### EPD (Environmental Product Declaration)

Marazzi Group ha valutato gli impatti ambientali legati ai propri prodotti lungo tutto il loro ciclo di vita, a partire dall'estrazione e lavorazione delle materie prime fino al recupero dei rifiuti di demolizione. I risultati di questa analisi LCA (life cycle assessment), condotta secondo le norme internazionali della serie ISO 14040, sono pubblicati nella dichiarazione ambientale di prodotto EPD (ISO 14025 e EN 15804) che contribuisce al raggiungimento di crediti per la certificazione LEED.

### DEP (Déclaration environnementale de produit)

Marazzi Group a évalué les impacts de ses produits sur l'environnement pendant tout leur cycle de vie, depuis l'extraction et la transformation des matières premières jusqu'à la récupération des déchets de démolition. Les résultats de cette analyse du cycle de vie (ACV), menée selon les normes internationales ISO 14040, sont publiés dans la Déclaration environnementale de produit (DEP) (selon les normes ISO 14025 et EN 15804) qui contribue à l'obtention des crédits pour la certification LEED.

### HPD (Healt Product Declaration)

Marazzi Group realizza i propri prodotti utilizzando materie prime di origine naturale, come argille, feldspati, sabbie e pigmenti inorganici. Per garantire la trasparenza delle informazioni, l'Azienda pubblica l'HPD (Health Product Declaration), un'autodichiarazione sulla composizione chimica del prodotto, che permette all'utilizzatore di verificare il grado e la tipologia di pericolosità associata ai singoli componenti dei prodotti da costruzione. L'HPD viene riconosciuta all'interno dei crediti LEED.

### HPD (Healt Product Declaration)

Marazzi Group fabrique ses produits à partir de matières premières d'origine naturelle, comme des argiles, des feldspaths, des sables et des pigments inorganiques. Pour garantir la transparence des informations, l'entreprise publie une FDES (Fiche de déclaration sanitaire du produit) : il s'agit d'une autodéclaration sur la composition chimique du produit qui permet à l'utilisateur de vérifier le degré et le type de danger associés aux différents composants des produits de construction. La FDES figure dans les crédits LEED.

### EPD (Environmental Product Declaration)

Marazzi Group has assessed its products' environmental impact throughout their life cycle, from extraction and processing of the raw materials through to the recycling of demolition spoil. The findings of this LCA (Life Cycle Assessment), performed in accordance with the ISO 14040 series international standards, have been published in the Environmental Product Declaration (ISO 14025 and EN 15804), contributing to the attainment of LEED certification credits.

### EPD (declaración ambiental de producto)

Marazzi Group ha evaluado el impacto ambiental relacionado con sus productos a lo largo de todo su ciclo de vida, desde la extracción y la transformación de las materias primas hasta la valorización de los residuos de la construcción y demolición. Los resultados de este análisis de ciclos de vida LCA (life cycle assessment), realizado de acuerdo con las normas internacionales de la serie ISO 14040, han sido publicados en la declaración ambiental de producto EPD (ISO 14025 y EN 15804) que contribuye a la obtención de los créditos para la certificación de sostenibilidad en la construcción LEED.

### HPD (Healt Product Declaration)

Marazzi Group manufactures its products using raw materials of natural origin, such as clays, feldspars, sands and inorganic pigments. To guarantee transparency of information, the Company publishes an HPD (Health Product Declaration), a self-declaration on the chemical composition of the product, which allows users to assess the degree and type of hazard associated with individual components of construction products. The HPD is recognised within the LEED credits system.

### HPD (Healt Product Declaration)

Marazzi Group realiza sus productos utilizando materias primas de origen natural, tales como arcillas, feldespatos, arenas y pigmentos inorgánicos. Para garantizar la transparencia de la información, la empresa publica una HPD (Health Product Declaration): una autodeclaración acerca de la composición química del producto mediante la cual el usuario puede comprobar el nivel y el tipo de peligro relacionados con cada componente de los productos de construcción. La HPD está reconocida en el ámbito de los créditos LEED.

### Umwelt-Produktdeklaration (Environmental Product Declaration, EPD)

Die Marazzi Group hat die Umweltwirkung der eigenen Produkte im Verlauf ihres gesamten Lebenszyklus beurteilt, beginnend bei der Rohstoffgewinnung und -verarbeitung bis hin zur Wiederverwertung von Bauschutt. Die Ergebnisse dieser Ökobilanz (Life Cycle Assessment, LCA) nach der internationalen Normenreihe ISO 14040 wurden in der Umwelt-Produktdeklaration EPD gemäß ISO 14025 und EN 15804 veröffentlicht, die zur Zuerkennung von Punkten für die Zertifizierung nach dem Zertifizierungssystem LEED beiträgt.

### EPD (Environmental Product Declaration, Экологическая декларация продукции)

Marazzi Group оценила воздействие на окружающую среду своей продукции в течение всего ее жизненного цикла, начиная с добычи и переработки сырья и вплоть до повторной переработки строительного мусора. Результаты этого анализа LCA (оценка жизненного цикла), проведенного в соответствии с международными нормами из серии ISO 14040, опубликованы в Экологической декларации продукции EPD (ISO 14025 и EN 15804), которая способствует получению кредитов для выдачи сертификата LEED.

### HPD (Healt Product Declaration)

Marazzi Group setzt für die Herstellung ihrer Produkte Rohstoffe natürlichen Ursprungs wie Ton, Feldspat, Sand und anorganische Pigmente ein. Zur Gewährleistung transparenter Informationen veröffentlicht das Unternehmen die HPD-Deklaration (Health Product Declaration), eine Eigenerklärung zur chemischen Zusammensetzung des Produkts, wodurch der Verbraucher das Ausmaß und die Art der gesundheitlichen Auswirkungen im Zusammenhang mit den Inhaltsstoffen der Bauprodukte prüfen kann. Die HPD trägt zur Erlangung der LEED-Punkte bei.

### HPD (Healt Product Declaration)

Marazzi Group выпускает свою продукцию из сырья натурального происхождения, такого как глина, полевые шпаты, песок и неорганические пигменты. Для гарантии прозрачности информации компания публикует декларацию безопасности продукции HPD (Health Product Declaration), корпоративное заявление о химическом составе продукции, которое позволяет пользователю проверить степень и тип опасности, связанной с отдельными компонентами строительных материалов. Декларация HPD признается в рамках кредитов LEED.

# Qualità e ambiente

quality and environment / qualität und umwelt / la qualité et l'environnement / calidad y ambiente / качество и окружающая среда



La filosofia di Marazzi Group è da sempre improntata al conseguimento di un prodotto tecnicamente all'avanguardia e dagli elevati standard qualitativi ed estetici. Marazzi Group è stata una delle prime aziende operanti nel settore ad aver ottenuto nel 1994 la certificazione ISO 9001 del proprio sistema di gestione della Qualità aziendale, dalla progettazione e sviluppo del prodotto, ai processi produttivi e alle attività di servizio. Marazzi Group dedica una grandissima attenzione all'ambiente, con la consapevolezza di dover gestire, con un approccio attivo, le problematiche derivanti dalla presenza produttiva sul territorio. Nel 2003 ha certificato il proprio sistema di gestione Ambientale secondo la norma ISO 14001. La sicurezza del personale è di fondamentale importanza per l'azienda, che cerca il miglioramento continuo attraverso costanti verifiche e controlli, investimenti e formazione, con il coinvolgimento diretto dei lavoratori. L'impegno di Marazzi Group è dimostrato dalla certificazione OH SAS 18001 del sistema di gestione della Salute e Sicurezza sul Lavoro.

Fidèle à sa philosophie, Marazzi Group a pour objectif de fabriquer un produit technique d'avant-garde et d'atteindre une qualité et une esthétique maximales. Marazzi Group a été l'une des premières entreprises du secteur à obtenir en 1994 la certification ISO 9001 pour son système de management de la qualité : des activités de conception et développement du produit aux processus de production, en passant par les services. Marazzi Group fait preuve d'un vif intérêt pour l'environnement, consciente qu'une démarche active est nécessaire pour gérer les problèmes occasionnés par sa présence sur le territoire. En 2003, l'entreprise a certifié son système de management environnemental selon la norme ISO 14001. Elle accorde une importance fondamentale à la sécurité du personnel et, pour cette raison, vise à une optimisation continue en mettant en œuvre des contrôles et audits fréquents, des investissements et des initiatives de formation avec la participation directe des travailleurs. Marazzi Group prouve son engagement par la certification OHSAS 18001 de son système de management de la santé et de la sécurité au travail.

The philosophy of Marazzi Group has always been geared towards achieving a technically advanced product with high quality and aesthetic standards. Marazzi Group was one of the first firms in the industry to obtain ISO 9001 certification, in 1994, for its quality management system, from product design and development to production processes and service activities. Marazzi Group pays considerable attention to the environment, conscious of its duty to take an active approach to managing the problems that derive from manufacturing in the area. In 2003, its environmental management system was certified according to the ISO 14001 standard. Employee safety is of fundamental importance for the company, which strives towards continuous improvement through constant tests and checks, investments and training, directly involving workers. The commitment of Marazzi Group is demonstrated by the OHSAS 18001 certification for the occupational health and safety management system.

La filosofía de Marazzi Group siempre se ha orientado hacia la consecución de un producto de vanguardia en lo técnico y de elevados estándares en lo cualitativo y lo estético. Marazzi Group fue una de las primeras empresas del sector en obtener, en 1994, la certificación ISO 9001 de su sistema de gestión de la calidad empresarial, desde el diseño y el desarrollo de los productos hasta los procesos de producción y las actividades de prestación de servicios. Marazzi Group dedica una extraordinaria atención al medio ambiente, consciente de que ha de gestionar con una actitud proactiva los problemas derivados de la presencia productiva en el territorio. En 2003 certificó su sistema de gestión medioambiental con arreglo a la norma ISO 14001. La seguridad del personal es de fundamental importancia para la empresa, que trata de mejorar continuamente por medio de controles y comprobaciones constantes, inversiones y formación, e involucrando de manera directa a los trabajadores. El compromiso de Marazzi Group en este sentido queda demostrado con la obtención de la certificación OHSAS 18001 de su sistema de gestión de la salud y la seguridad en el trabajo.

Принципы работы компании Marazzi Group всегда нацелены на производство технически передовой продукции, с высокими стандартами качества и эстетики. Marazzi Group была одной из первых компаний в этой отрасли, получившей в 1994 году сертификат соответствия стандарту ISO 9001 своей Системы менеджмента качества, охватывающей весь процесс: от проектирования и развития продукции до производственных процессов и деятельности по обслуживанию. Marazzi Group уделяет огромное внимание окружающей среде, осознавая, что она должна иметь активный подход к решению проблем, связанных с наличием производства на территории. В 2003 году она сертифицировала свою Систему экологического менеджмента на соответствие стандарту ISO 14001. Безопасность персонала имеет фундаментальную важность для компании, которая непрерывно работает над улучшениями, постоянно осуществляя проверки и контроль, инвестиции и подготовку при непосредственном участии сотрудников. Предпринимаемые Marazzi Group усилия подтверждаются сертификацией OHSAS 18001 Системы охраны здоровья и обеспечения безопасности труда.

Principii de lucru ale companiei Marazzi Group sunt intotdeauna orientate catre fabricarea unei produse tehnice avansate, cu o calitate si o estetica ridicate. Marazzi Group a fost una din primele companii din industria care a obtinut in 1994 certificarea ISO 9001 pentru sistemul sau de management al calitatii, de la proiectarea si dezvoltarea produselor si procesele de productie si activitatile de servicii. Marazzi Group acorda o mare atentie mediului inconjurator, fiind constienta de datoria sa de a aborda activ problemele care deriva din activitatea de productie in zona. In 2003, sistemul sau de management al mediului inconjurator a fost certificat conform standardului ISO 14001. Siguranta personalului este de o importanta fundamentala pentru companie, care se straduieste sa realizeze imbunatatiri continue prin teste si verificari constante si investitii si formare, implicand direct pe lucrorii. Angajamentul companiei Marazzi Group este demonstrat de certificarea OHSAS 18001 pentru sistemul de management al sanatatii si al sigurantei la locul de munca.

## Le norme UNI EN

UNI EN regulations / die UNI EN-normen / les normes UNI EN / las normas UNI EN / нормы UNI EN

Le norme UNI EN, recepite dal CEN, (Commissiòn Euro-peenne de Normalisation), hanno valore in tutta Europa e interessano tutti i tipi di piastrelle, pressate e trafilate, smaltate e non smaltate, di qualunque formato, di sola 1° scelta. Le norme UNI EN trovano corrispondenza con alcune modifiche delle nuove norme internazionali ISO e si compongono di:

### NORME GENERALI

La nuova norma armonizzata EN 14411 fornisce definizioni, classificazione, caratteristiche e marcatura per le piastrelle di ceramica ed annulla e sostituisce la norma EN 87.

La nuova normativa UNI EN ISO 105454\_1 stabilisce le regole per la composizione del lotto di campionamento e sostituisce la precedente norma EN 163.

### NORME DI PRODOTTO

Le piastrelle di ceramica sono suddivise in gruppi secondo il metodo di formatura ed il grado di assorbimento d'acqua. Sono contraddistinti due gruppi A e B, in funzione del metodo di formatura:

**A** Piastrelle estruse (ovvero formate tramite il passaggio della materia allo stato plastico, attraverso un "trafilatore" che costituisce un nastro in seguito tagliato alla misura voluta).

**B** Piastrelle pressate (ovvero ottenute tramite la pressione della materia prima allo stato di polvere secca, in appositi stampi). Tali piastrelle possono essere smaltate successivamente, o non smaltate.

I gruppi sono a loro volta suddivisi in sottogruppi, secondo il grado di assorbimento d'acqua (porosità) presentato:

- Gruppo B Ia	= E ≤ 0,5%	UNI EN 14411_G
- Gruppo B Ib	= 0,5% < E ≤ 3%	UNI EN 14411_H
- Gruppo B IIa	= 3% < E ≤ 6%	UNI EN 14411_J
- Gruppo B IIb	= 6% < E ≤ 10%	UNI EN 14411_K
- Gruppo B III	= E > 10%	UNI EN 14411_L

Le norme definiscono per ogni gruppo di prodotti le dimensioni, le tolleranze dimensionali, le caratteristiche meccaniche, fisiche e chimiche, l'aspetto e la designazione delle piastrelle ceramiche. Le piastrelle dell'attuale gamma Ragno sono tutte ottenute per pressatura e appartengono ai gruppi B Ia, B Ib, B IIa, B III.

### NORME PER I METODI DI PROVA

Queste norme definiscono i metodi per la determinazione delle caratteristiche dimensionali e di aspetto, delle proprietà fisiche e delle proprietà chimiche. La norma 14411 fa riferimento ai metodi di prova delle nuove norme UNI EN ISO 10545.

The UNI EN standards, adopted by the CEN (European Committee for Standardization) are valid throughout Europe and apply to all types of first choice tiles, pressed and extruded, glazed and unglazed, of any size. The UNI EN standards are compatible with the latest amendments of the new ISO international standards, and include:

### GENERAL REGULATIONS

The new harmonised standard EN 14411 that provides definitions, classifications, features and designation requirements for ceramic tiles and annuls and replaces standard EN 87.

The new standard UNI EN ISO 105454\_1 that sets forth the rules for the composition of sample lots, and replaces the previous standard EN 163.

### PRODUCT REGULATIONS

Ceramic tiles are divided into groups according to how they are formed and their water absorption characteristics. In terms of forming methods, there are two groups: A and B:

**A** Extruded tiles (formed by means of passing a malleable paste through an extrusion machine; the resulting band is cut into the desired dimensions).

**B** Pressed tiles (obtained by pressing powdered raw materials in special molds). Afterwards, these tiles may be glazed or not.

The groups are broken down further according to their water absorption characteristics (porosity):

- Group B Ia	= E ≤ 0,5%	UNI EN 14411_G
- Group B Ib	= 0,5% < E ≤ 3%	UNI EN 14411_H
- Group B IIa	= 3% < E ≤ 6%	UNI EN 14411_J
- Group B IIb	= 6% < E ≤ 10%	UNI EN 14411_K
- Group B III	= E > 10%	UNI EN 14411_L

The regulations define the sizes, the size tolerances, the mechanical, physical and chemical properties, the appearance and designation of the ceramic tiles in each group. The present range of Ragno tiles is entirely composed of pressed tiles and belongs to groups B Ia, B Ib, B IIa, and B III.

### REGULATIONS FOR TESTING METHODS

These regulations define the methods to be used for determining size and appearance characteristics, as well as physical and chemical properties. Standard 14411 refers to the testing methods of the new UNI EN ISO 10545 standard.

Die vom CEN (Europäisches Komitee für Normung) aufgenommenen UNI EN-Normen sind in ganz Europa gültig und betreffen alle Typen von gepressten, gezogenen, glasierten und unglasierten Fliesen jeglichen Formats ausschließlich erster Wahl. Die UNI EN Normen finden mit einigen Änderungen der neuen internationalen ISO-Normen Entsprechung und setzen sich wie folgt zusammen:

### ALLGEMEINE NORMEN

Die neue harmonisierte Norm EN 14411 gibt Begriffe, Klassifizierung, Gütemerkmale und Kennzeichnung für keramische Fliesen an und annulliert und ersetzt die Norm EN 87.

Die neue Norm UNI EN ISO 105454\_1 legt die Regeln für die Zusammensetzung des Musterungsloses fest und ersetzt die vorherige Norm EN 163.

### PRODUKTNORMEN

Keramikfliesen werden nach ihrer Formungsweise und ihres Wasseraufnahmevermögens in Gruppen eingeteilt. Je nach der Formungsmethode werden die Gruppen A und B unterschieden:

**A** Gezogene Fliesen (das heißt Fliesen, die durch den Durchgang des Materials im plastischen Zustand durch eine Strangpresse zu einem Streifen geformt werden, der anschließend in einzelne Fliesen mit dem gewünschten Maß zerschnitten wird).

**B** Gepreßte Fliesen (die ausgehend von Rohmaterialien in Pulverform durch Pressung in speziellen Formwerk- zeugen erzielt werden). Diese Fliesen können anschließend glasiert werden oder unglasiert bleiben.

Diese Gruppen werden wiederum nach ihrer Wasserauf-nahme (Porosität) in Gruppen eingeteilt:

- Gruppe B Ia	= E ≤ 0,5%	UNI EN 14411_G
- Gruppe B Ib	= 0,5% < E ≤ 3%	UNI EN 14411_H
- Gruppe B IIa	= 3% < E ≤ 6%	UNI EN 14411_J
- Gruppe B IIb	= 6% < E ≤ 10%	UNI EN 14411_K
- Gruppe B III	= E > 10%	UNI EN 14411_L

Die Normen bestimmen für jede Produktgruppe Abmessungen, Maßtoleranzen, mechanische, physikalische und chemische Eigenschaften, Aussehen und die Bezeichnung der Keramikfliesen. Alle Fliesen der derzeitigen Ragno-Produktpalette werden durch Pressung erzielt und gehören den Gruppen B Ia, B Ib, B IIa, B III an.

### NORMEN FÜR DIE PRÜFMETHODEN

Diese Normen bestimmen die Methoden zur Feststellung der Eigenschaften hinsichtlich der Abmessungen und des Aussehens, der physikalischen und der chemischen Merkmale.

Die Norm 14411 bezieht sich auf die Prüfmethode nach den neuen Normen UNI EN ISO 10545.

Les normes UNI EN, reconnues par le CEN (Comité Européen de Normalisation), sont valables dans toute l'Europe et concernent tous les types de carreaux, pressés et étirés, émaillés et non émaillés, de n'importe quel format, exclusivement de premier choix. Les normes UNI EN se sont adaptées aux dernières dispositions des nouvelles normes internationales ISO et se composent de:

### NORMES GÉNÉRALES

La nouvelle norme harmonisée EN 14411 qui fixe les définitions, la classification, les caractéristiques et le marquage des carreaux céramiques, annule et remplace la norme EN 87.

La nouvelle norme UNI EN ISO 105454\_1 établit les règles pour la composition du lot d'échantillonnage et remplace la norme EN 163.

### NORMES DE PRODUIT

Les carreaux en céramique sont divisés en groupes selon le type de façonnage et leur porosité. Ils font partie de la classe A ou B suivant le type de façonnage:

**A** Carreaux extrudés (c'est-à-dire façonnés par le passage de la matière à l'état plastique dans une extrudeuse; la bande formée est ensuite coupée à la mesure désirée).

**B** Carreaux pressés (c'est-à-dire obtenus par pression de la matière première à l'état de poudre sèche, dans des moules spéciaux). Ces carreaux peuvent ensuite être émaillés ou non.

Les groupes sont divisés en sous-groupes suivant le degré d'absorption d'eau (porosité):

- Groupe B Ia	= E ≤ 0,5%	UNI EN 14411_G
- Groupe B Ib	= 0,5% < E ≤ 3%	UNI EN 14411_H
- Groupe B IIa	= 3% < E ≤ 6%	UNI EN 14411_J
- Groupe B IIb	= 6% < E ≤ 10%	UNI EN 14411_K
- Groupe B III	= E > 10%	UNI EN 14411_L

Les normes définissent, pour chaque groupe de produits, les dimensions, les tolérances dimensionnelles, les caractéristiques mécaniques, physiques et chimiques, l'aspect et la désignation des carreaux céramiques. Les carreaux de la gamme Ragno sont tous obtenus par pressage et appartiennent aux groupes B Ia, B Ib, B IIa, B III.

### NORMES POUR LES METHODES D'ESSAI

Ces normes définissent les méthodes pour la détermination des caractéristiques dimensionnelles et d'aspect, des proprié-tés physiques et des propriétés chimiques.

La norme 14411 se réfère aux méthodes d'essai des nouvelles normes UNI EN ISO 10545.

Las normas UNI EN, acogidas por el CEN (Comisión Europea para la Normalización), se consideran válidas en toda Europa y comprenden todas las categorías de azulejos, prensados o extruidos, esmaltados y no esmaltados, de cualquier formato, únicamente de 1ª calidad. Las normas UNI EN están en sintonía con algunas modificaciones de las nuevas normas internacionales ISO y están formadas por:

### NORMAS GENERALES

La nueva norma armonizada EN 14411, que facilita las definiciones, clasificaciones, características y requisitos de denominación para los azulejos de cerámica y anula y substituye a la norma EN 87.

La nueva normativa UNI EN ISO 105454\_1, que establece las reglas para la composición de la partida de muestreo y substituye a la norma anterior EN 163.

### NORMAS DE PRODUCTO

Los azulejos cerámicos se dividen en grupos según el método de moldeo utilizado y el nivel de absorción del agua. Se distinguen 2 grupos A y B en función de luego se corta de acuerdo con la medida deseada).

**A** Azulejos extruidos (es decir, que se forman pasando la materia al estado plástico por medio de una "extrusionadora", que forma por una cinta que luego se corta de acuerdo con la medida deseada).

**B** Azulejos prensados (es decir, que se forman prensando la materia prima en polvo seco dentro de moldes especiales). Se trata de azulejos que se pueden esmaltar sucesivamente o dejar sin esmalte.

Los grupos se dividen a su vez en grupos secundarios de acuerdo con el nivel de absorción del agua (porosidad):

- Grupo B Ia	= E ≤ 0,5%	UNI EN 14411_G
- Grupo B Ib	= 0,5% < E ≤ 3%	UNI EN 14411_H
- Grupo B IIa	= 3% < E ≤ 6%	UNI EN 14411_J
- Grupo B IIb	= 6% < E ≤ 10%	UNI EN 14411_K
- Grupo B III	= E > 10%	UNI EN 14411_L

Las normas establecen por cada grupo de productos, las dimensiones, las tolerancias dimensionales, las características mecánicas, físicas y químicas, el aspecto y la denominación de azulejos cerámicos. Los azulejos de la actual gama Ragno se obtienen mediante prensado y pertenecen a los grupos B Ia, B Ib, B IIa, B III.

### NORMAS PARA LOS MÉTODOS DE PRUEBA

Dichas normas establecen los métodos para la determinación de las características dimensionales y de aspecto, de las propiedades físicas y de las propiedades químicas. La norma 14411 se refiere a los métodos de prueba de las nuevas normas UNI EN ISO 10545.

Normy UNI EN, priinyatyè CEN (Comité Européen de Normalisation), imeyut silu vo vsej Evrope i raspristranyayutsya na vse tipy plitki, pressovannyye i ekstrudirovannyye, glazurovannyye i negliazurovannyye, lyubogo formata, tolyko 1 sorta. Normy UNI EN sootvetstvuyut nekotorym izmeneniyam novyyh mezhdunarodnyh norm i vkluchayut v sebya:

### ОБЩИЕ НОРМЫ

Новая согласованная норма EN 14411 приводит определения, классификацию, характеристики и требования к маркировке керамической плитки, она отменяет и заменяет норму EN 87.

Новая норма UNI EN ISO 105454\_1 определяет правила составления опытной партии и заменяет предыдущую норму EN 163.

### НОРМЫ НА ПРОДУКЦИЮ

Керамическая плитка подразделяется на группы по методам формовки и степени водопоглощения. В зависимости от метода формовки выделяются две группы - А и В:

**A** Экструдированная плитка (то есть образованная прохождением пластичного сырья через экструдер и разрезанием иолуенной ленты по необходимому размеру).

**B** Прессованная плитка (то есть полученная прессованием сырья в виде сухого порошка в специальных пресс-формах). Далее эта плитка может глазуроваться или нет.

В свою очередь, группы подразделяются на подгруппы по степени имеющегося водопоглощения (пористости):

- Грунна B Ia	= E ≤ 0,5%	UNI EN 14411_G
- Грунна B Ib	= 0,5% < E ≤ 3%	UNI EN 14411_H
- Грунна B IIa	= 3% < E ≤ 6%	UNI EN 14411_J
- Грунна B IIb	= 6% < E ≤ 10%	UNI EN 14411_K
- Грунна B III	= E > 10%	UNI EN 14411_L

Для каждой группы продукции нормы определяют размеры, размерные допуски, механические, физические и химические характеристики, внешний вид назначение керамической плитки. Плитка данной гаммы Ragno полностью получена прессованием и принадлежит к группам B Ia, B Ib, B IIa, B III.

### НОРМЫ ДЛЯ МЕТОДОВ ИСПЫТАНИЯ

Эти нормы устанавливают методы определения размерных характеристики и внешнего вида, физических и химических свойств.

Норма 14411 ссылается на методы испытания новых норм UNI EN ISO 105454.



# Caratteristiche tecniche MAIORA MARBLE

technical characteristics / technische eigenschaften / caracteristiques technique / datos tecnicos / технические характеристики

I dati riportati sulla tabella tecnica si riferiscono solo ai fondi / Technical chart data refer to plain tiles only / Die technischen Daten beziehen sich nur auf die Grundfliesen / Les données figurant dans le tableau technique se rapportent uniquement aux fonds / Los datos que figuran en la tabla técnica se refieren únicamente a los fondos / Данные, приведенные в технической таблице, относятся лишь только к фоновой плитке

CARATTERISTICA CHARACTERISTIC EIGENSCHAFTEN CARACTERÍSTIQUE CARACTERÍSTICA ХАРАКТЕРИСТИКА	METODO DI PROVA TESTING METHOD PRÜFMETHODE MÉTHODE D'ESSAI MÉTODO DE PRUEBA МЕТОД ИСПЫТАНИЯ	UNITÀ DI MISURA MEASUREMENT UNIT MAßEINHEIT UNITE DE MESURE UNIDAD DE MEDIDA ЕДИНИЦА ИЗМЕРЕНИЯ	VALORI TIPICI MEDI AVERAGE TYPICAL VALUES TYPISCHE DURCHSCHNITTSWERTE VALEURS MOYENNES TYPIQUES VALORES TÍPICOS MEDIOS СРЕДНИЕ ТИПОВЫЕ ЗНАЧЕНИЯ	VALORI LIMITE PREVISTI ESTABLISHED LIMITS VORGESEHENE GRENZWERTE VALEURS LIMITES PREVUES VALORES LIMITE PREVISTOS ОЖИДАЕМЫЕ ПРЕДЕЛЬНЫЕ ЗНАЧЕНИЯ	NORMA DI RIFERIMENTO REFERENCE STANDARD BEZUGSNORM NORME DE REFERENCES NORMA DE REFERENCIA СТАНДАРТ ДЛЯ СРАВКИ
Tolleranze dimensionali Dimensions - Abmessungen Dimensions - Dimensiones Размерные допуски	ISO 10545_2	mm %	Conforme Compliant Konform Conforme Conforme Соответствует	N > 15	UNI EN 14411-G
Lunghezza e larghezza Length and width Länge und Breite Longueur et largeur Longitud y anchura Длина и ширина				[a] ± 2% (max 5 mm)      ± 2% (max 5 mm)	
Ortogonalità - Rectangularity Rechtwinkligkeit - Orthogonalité Ortogonalidad - Ортогональность				± 0,5%      ± 2,0 mm	
Spessore - Thickness Stärke - Epaisseur Espesor - Толщина				± 5%      ± 0,5 mm	
Rettilinearità degli spigoli Edge straightness Rechtlinigkeit der Kanten Rectitude des arêtes Rectitud de las esquinas Прямолинейность кромок				± 0,5%      ± 1,5 mm	
Planarità - Flatness Ebenflächigkeit - Planéité Planeidad - Плоскостность				[c] ± 0,5%      ± 2,0 mm	
Aspetto - Appearance Aspekt - Aspect Аспект - Внешний вид			> 95%		
Assorbimento d'acqua Water absorption Wasseraufnahme Absorption d'eau Absorción de agua Водопоглощение	ISO 10545_3	%	< 0,5	< 0,5 Valore singolo massimo 0,6% Maximum single value 0,6% Maximaler Einzelwert 0,6% Valeur unitaire maximale 0,6% Valor máximo individual 0,6% Максимальное отдельное значение 0,6%	
Resistenza alla flessione Resistance to bending Biegefestigkeit Résistance à la flexion Resistencia a la flexión Сопротивление изгибу Modulo di rottura Modulus of rupture Bruchlast - Module de rupture Módulo de rotura Предел прочности при разрыве	ISO 10545_4	N/mm²	> 35	R > 35 Valore singolo minimo 32 Minimum single value 32 Geringer Einzelwert 32 Valeur unique minimale 32 Valor unico minimo 32 Минимальное отдельное значение 32	UNI EN 14411-G
Sforzo di rottura Breaking strength Bruchkraft Force de Rupture Esfuerzo de rotura Разрывное усилие	ISO 10545_4	N	> 1300	> 1300 N	UNI EN 14411-G
Resistenza all'abrasione profonda Resistance to deep abrasion Tiefenabriebfestigkeit Résistance à l'abrasion profonde Resistencia a la abrasión profunda Устойчивость к глубокому истиранию	ISO 10545_6	mm³	< 175	< 175	UNI EN 14411-G
Resistenza all'abrasione superficiale Resistance to surface abrasion Abriebfestigkeit Résistance à l'abrasion superficielle Resistencia a la abrasión superficial Стойкость к поверхностному истиранию	metodo interno internal method Interne Methode méthode interne método interno внутренний метод	classe interna internal class Interne Klassifizierung classe interne classe interna внутренний класс	G Naturale/Matt F Glossy		UNI EN 14411-G
Resistenza al gelo Frost resistance Frostbeständigkeit Résistance au gel Resistencia al helado Морозостойкость	ISO 10545_12		Conforme Compliant Konform Conforme Conforme Соответствует	Prova superata secondo la EN ISO 10545-1 - Test passed in accordance with EN ISO 10545-1 - Prüfung gemäß EN ISO 10545-1 bestanden - Essai réussi conformément à la norme EN ISO 10545-1 - Prueba superada de conformidad con la EN ISO 10545-1 - Испытание пройдено в соответствии со стандартом EN ISO 10545-1	UNI EN 14411-G
Resistenza agli sbalzi termici Thermal shock resistance Widerstandsfähigkeit Temperaturschwankungen Résistance aux chocs thermiques Resistencia al choque térmico Стойкость к тепловым перепадам	ISO 10545_9		Conforme Compliant Konform Conforme Conforme Соответствует	Prova superata secondo la EN ISO 10545-1 - Test passed in accordance with EN ISO 10545-1 - Prüfung gemäß EN ISO 10545-1 bestanden - Essai réussi conformément à la norme EN ISO 10545-1 - Prueba superada de conformidad con la EN ISO 10545-1 - Испытание пройдено в соответствии со стандартом EN ISO 10545-1	UNI EN 14411-G
Coefficiente di dilatazione termica lineare Coefficient of linear thermal expansion Linearer Wärmeausdehnungs-Koeffizient Coefficient linéaire de dilatation thermique Coeficiente de dilatación térmica lineal Кoefficient линейного теплового расширения	ISO 10545_8	X10 <sup>-4</sup> / °C	< 9	Valore dichiarato Value declared Erklärter wert Valeur déclarée Valor declarado Заявленное значение	UNI EN 14411-G

CARATTERISTICA CHARACTERISTIC EIGENSCHAFTEN CARACTERÍSTIQUE CARACTERÍSTICA ХАРАКТЕРИСТИКА	METODO DI PROVA TESTING METHOD PRÜFMETHODE MÉTHODE D'ESSAI MÉTODO DE PRUEBA МЕТОД ИСПЫТАНИЯ	UNITÀ DI MISURA MEASUREMENT UNIT MAßEINHEIT UNITE DE MESURE UNIDAD DE MEDIDA ЕДИНИЦА ИЗМЕРЕНИЯ	VALORI TIPICI MEDI AVERAGE TYPICAL VALUES TYPISCHE DURCHSCHNITTSWERTE VALEURS MOYENNES TYPIQUES VALORES TÍPICOS MEDIOS СРЕДНИЕ ТИПОВЫЕ ЗНАЧЕНИЯ	VALORI LIMITE PREVISTI ESTABLISHED LIMITS VORGESEHENE GRENZWERTE VALEURS LIMITES PREVUES VALORES LIMITE PREVISTOS ОЖИДАЕМЫЕ ПРЕДЕЛЬНЫЕ ЗНАЧЕНИЯ	NORMA DI RIFERIMENTO REFERENCE STANDARD BEZUGSNORM NORME DE REFERENCES NORMA DE REFERENCIA СТАНДАРТ ДЛЯ СРАВКИ
Resistenza alle macchie Resistance to staining Beständigkeit gegen Fleckenbildner Résistance aux produits tachants Resistencia a las manchas Стойкость к пятнообразованию	ISO 10545_14		Naturale/Matt classe 5 - classe 5 - classe 5 - categoria 5 - класс 5  Glossy da classe 5 a classe 3 - class 5 to class 3 - von Klasse 5 bis Klasse 3 - de classe 5 à classe 3 - de categoria 5 a categoria 3 - от класс 5 до класс 3	classe 3 minimo class 3 minimum Mind. Klasse 3 classe 3 minimum categoria 3 minimo минимум класс 3	UNI EN 14411-G
Resistenza ai prodotti chimici di uso domestico e sali per piscina - Resistance to chemicals for household use and swimming pool salts - Beständigkeit gegen Haushaltschemikalien und Zusätze für Schwimmbäder - Résistance aux produits chimiques d'usage domestique et sels pour piscine - Resistencia a los productos químicos para uso doméstico y sales para piscina - Устойчивость к бытовым химическим средствам и солям для бассейнов	ISO 10545_13		A Naturale/Matt A-B Glossy	B minimo B minimum Mind. B B minimum B minimo Минимальный UB	UNI EN 14411-G
Resistenza agli acidi e alle basi Resistance to acids and bases Säure- und Laugenfestigkeit Résistance aux acides et aux bases Resistencia a los ácidos y a las bases Стойкость к кислотам и щелочам			LA - LB HA - HB	Valore dichiarato Value declared Erklärter wert Valeur déclarée Valor declarado Заявленное значение	UNI EN 14411-G
Resistenza dei colori alla luce Colour resistance to light exposure Farblichkeit unter Lichteinfluss Résistance des couleurs à la lumière Resistencia de los colores a la exposición de la luz Светостойкость цветов	DIN 51094		Conforme Compliant Konform Conforme Conforme Соответствует	Non devono presentare apprezzabili alterazioni di colore - No sample must show noticeable colour modifications - Aucun échantillon ne doit présenter d'altérations appréciables de couleur - Kein Muster darf sichtbare Farbveränderungen aufweisen - Ninguna muestra ha de presentar alteraciones apreciables de color - Ни один из образцов не должен иметь значимых изменений цветов	
Resistenza allo scivolamento - Skid resistance - Rutschhemmung - Résistance au glissement Resistencia al deslizamiento - Coproivaleenie проскальзыванию	RAMP METHOD		R9 Naturale/Matt	da R9 a R13 - from R9 to R13 - von R9 bis R13 - de R9 a R13 - de R9 a R13 - от R9 до R13	DIN 51130 DGUV REGEL 108-003*
Coefficiente di attrito medio Mean coefficient of friction Mittlerer Reibungskoeffizient Coefficient de frottement moyen Coefficient de roce medio Средний коэффициент трения	B.C.R.		μ > 0,40 Naturale/Matt	μ > 0,40	D.M. N°236 14/6/1989
Resistenza allo scivolamento - Skid resistance - Rutschhemmung - Résistance au glissement Resistencia al deslizamiento - Coproivaleenie проскальзыванию	DIGITAL TRIBOMETER [ID-CDF]		> 0,42 Naturale/Matt	> 0,42	ANSI A326.3:2017

- (a) Differenza ammissibile tra dimensione di fabbricazione e dimensione nominale - Permissible difference between work size and nominal size - Zulässige Differenz zwischen Werksmaß und Nenmmaß - Différence admissible entre la dimension de fabrication et la dimension nominale - Diferencia admisible entre medida de fabricación y medida nominal - Допустимая разница между фактическим размером изделия и номинальным.
- (b) Deviazione ammissibile in % della dimensione media di una singola piastrella (2 o 4 lati) dalla dimensione di fabbricazione - Permissible % variation in the average size of a single tile (2 or 4 sides) from the work size - Zulässige Abweichung, in %, der mittleren Größe einer Einzelfliese (2 oder 4 Seiten) vom Werksmaß - Déviation admissible en % de la dimension moyenne d'un seul carreau (2 ou 4 côtés) par rapport à la dimension de fabrication - En porcentaje, desviación admisible del tamaño medio de un solo azulejo (2 o 4 lados) con respecto a la medida de fabricación - Допустимое отклонение в % среднего размера каждой плитки (2 или 4 стороны) от фактических размеров.
- (c) c.c. Deviazione massima ammissibile della curvatura del centro, in % oppure mm, in rapporto alla diagonale calcolata secondo le dimensioni di fabbricazione | e.c. Deviazione massima ammissibile della curvatura dello spigolo, in % oppure mm, in rapporto alle dimensioni di fabbricazione corrispondenti | w. Deviazione massima ammissibile dello svergolamento, in % oppure mm, in rapporto alla diagonale calcolata secondo le dimensioni di fabbricazione - c.c. Maximum permissible deviation, in % or mm, in the centre curvature from the diagonal calculated on the basis of the work size | e.c. Maximum permissible deviation, in % or mm, from the diagonal calculated on the basis of the work size - c.c. Maximal zulässige Abweichung der Mittelpunktwölbung, in % oder mm, bezogen auf die über das Werksmaß berechnete Diagonale | w. Maximal zulässige Abweichung der Kantenwölbung, in % oder mm, bezogen auf das zugehörige Werksmaß | w. Maximal zulässige Abweichung der Windschiefe, in % oder mm, bezogen auf die über das Werksmaß berechnete Diagonale - c.c. Déviation maximale admissible de la courbure du centre, en % ou en mm, par rapport à la diagonale calculée selon les dimensions de fabrication | e.c. Déviation maximale admissible de la courbure de l'angle, en % ou en mm, par rapport aux dimensions de fabrication correspondantes | w. Déviation maximale admissible du voile en % ou en mm, par rapport à la diagonale calculée selon les dimensions de fabrication - c.c. En porcentaje o en milímetros, desviación máxima admisible de la curvatura del centro con respecto a la diagonal calculada según las medidas de fabricación | e.c. En porcentaje o en milímetros, desviación máxima admisible de la curvatura de la esquina con respecto a las medidas de fabricación correspondientes | w. En porcentaje o en milímetros, desviación máxima admisible del abarquillamiento con respecto a la diagonal calculada según las medidas de fabricación - c.c. Максимальное допустимое отклонение изгиба центра в % или в мм по отношению к диагонали, рассчитанное по фактическим размерам | e.c. Максимальное допустимое отклонение изгиба кромок в % или в мм по отношению к соответствующим фактическим размерам | w. Максимальное допустимое отклонение перекоса в % или в мм по отношению к диагонали, рассчитанное по фактическим размерам.
- \* Pavimentazioni di ambienti lavorativi e zone operative con superfici sdrucciolevoli. - Flooring of work environments and operating areas with slippery surface. - Bodenbeläge für Arbeitsräume und Arbeitsbereiche mit Rutschgefahr. - Sols de locaux industriels et de zones de travail à surfaces dérapantes. - Pavimentaciones de zonas de trabajo operativas con superficies resbaladizas. - Полы в рабочих помещениях и рабочих зонах со скользкими поверхностями.
- \*\* Pavimentazioni per zone bagnate con calpestio a piedi scalzi. - Flooring for wet areas to be walked on barefoot. - Bodenbeläge in nassbelasteten Barfußbereichen. - Sols pour zones mouillées avec piétement pieds nus. - Pavimentaciones para zonas mojadas donde se camina con pies descalzos. - Полы для влажных зон, предназначенные для хождения по ним босиком.

# Caratteristiche tecniche MAIORA CONCRETE

technical characteristics / technische eigenschaften / caracteristiques technique / datos tecnicos / технические характеристики

I dati riportati sulla tabella tecnica si riferiscono solo ai fondi / Technical chart data refer to plain tiles only / Die technischen Daten beziehen sich nur auf die Grundfliesen / Les données figurant dans le tableau technique se rapportent uniquement aux fonds / Los datos que figuran en la tabla técnica se refieren únicamente a los fondos / Данные, приведенные в технической таблице, относятся лишь только к фоновой плитке

CARATTERISTICA CHARACTERISTIC EIGENSCHAFTEN CARACTERISTIQUE CARACTERÍSTICA ХАРАКТЕРИСТИКА	METODO DI PROVA TESTING METHOD PRÜFMETHODE MÉTHODE D'ESSAI MÉTODO DE PRUEBA МЕТОД ИСПЫТАНИЯ	UNITA DI MISURA MEASUREMENT UNIT MAßEINHEIT UNITE DE MESURE UNIDAD DE MEDIDA ЕДИНИЦА ИЗМЕРЕНИЯ	VALORI TIPICI MEDI AVERAGE TYPICAL VALUES TYPISCHE DURCHSCHNITTSWERTE VALEURS MOYENNES TYPIQUES VALORES TÍPICOS MEDIOS СРЕДНИЕ ТИПОВЫЕ ЗНАЧЕНИЯ	VALORI LIMITE PREVISTI ESTABLISHED LIMITS VORGEGEHENE GRENZWERTE VALEURS LIMITES PREVUES VALORES LIMITE PREVISTOS ОЖИДАЕМЫЕ ПРЕДЕЛЬНЫЕ ЗНАЧЕНИЯ	NORMA DI RIFERIMENTO REFERENCE STANDARD BEZUGSNORM NORME DE REFERENCIAS NORMA DE REFERENCIA СТАНДАРТ ДЛЯ СРАВКИ
Tolleranze dimensionali Dimensions - Abmessungen Dimensions - Dimensiones Размерные допуски	ISO 10545_2	mm %	Conforme Compliant Konform Conforme Conforme Соответствует	N > 15	UNI EN 14411-G
Lunghezza e larghezza Length and width Länge und Breite Longueur et largeur Longitud y anchura Длина и ширина				(a) ± 2% (max 5 mm) ± 2% (max 5 mm)	
Ortogonalità - Rectangularity Rechtwinkligkeit - Orthogonalité Ortogonalidad - Ортогональность				(b) ± 0,6% ± 2,0 mm	
Spessore - Thickness Stärke - Epaisseur Espesor - Толщина				± 0,5% ± 2,0 mm	
Rettilinearità degli spigoli Edge straightness Rechtlinigkeit der Kanten Rectitude des arêtes Rectitud de las esquinas Правильность кромок				± 5% ± 0,5 mm	
Pianità - Flatness Ebenförmigkeit - Planéité Planidad - Плоскость				± 0,5% ± 1,5 mm	
Aspetto - Appearance Aspekt - Aspect Аспект - Внешний вид				(c) ± 0,5% ± 2,0 mm	
Assorbimento d'acqua Water absorption Wasseraufnahme Absorption d'eau Absorción de agua Водопоглощение	ISO 10545_3	%	< 0,5	< 0,5 Valore singolo massimo 0,6% Maximum single value 0,6% Maximaler Einzelwert 0,6% Valeur unitaire maximale 0,6% Valor máximo individual 0,6% Максимальное отдельное значение 0,6%	
Resistenza alla flessione Resistance to bending Biegefestigkeit Résistance à la flexion Resistencia a la flexión Сопротивление изгибу	ISO 10545_4	N/mm²	> 35	R > 35 Valore singolo minimo 32 Minimum single value 32 Geringer Einzelwert 32 Valeur unique minimale 32 Valor unico minimo 32 Минимальное отдельное значение 32	UNI EN 14411-G
Modulo di rottura Modulus of rupture Bruchlast - Module de rupture Módulo de rotura Предел прочности при разрыве					
Storzo di rottura Breaking strength Bruchkraft Force de Rupture Esfuerzo de rotura Разрывное усилие	ISO 10545_4	N	> 1300 N	> 1300 N	UNI EN 14411-G
Resistenza all'abrasione profonda Resistance to deep abrasion Tiefenabriebfestigkeit Résistance à l'abrasion profonde Resistencia a la abrasión profunda Устойчивость к глубокому истиранию	ISO 10545_6	mm³	< 175	< 175	UNI EN 14411-G
Resistenza all'abrasione superficiale Resistance to surface abrasion Abriebfestigkeit Résistance à l'abrasion superficielle Resistencia a la abrasión superficial Стойкость к поверхностному истиранию	metodo interno internal method Interne Methode méthode interne método interno внутренний метод	classe interna internal class Interne Klassifizierung classe interne clase interna внутренний класс	H		UNI EN 14411-G
Resistenza al gelo Frost resistance Frostbeständigkeit Résistance au gel Resistencia al helado Морозостойкость	ISO 10545_12		Conforme Compliant Konform Conforme Conforme Соответствует	Prova superata secondo la EN ISO 10545-1 - Test passed in accordance with EN ISO 10545-1 - Prüfung gemäß EN ISO 10545-1 bestanden - Essai réussi conformément à la norme EN ISO 10545-1 - Prueba superada de conformidad con la EN ISO 10545-1 - Испытание пройдено в соответствии со стандартом EN ISO 10545-1	UNI EN 14411-G
Resistenza agli sbalzi termici Thermal shock resistance Widerstandsfähigkeit Temperaturschwankungen Résistance aux chocs thermiques Resistencia al choque térmico Стойкость к тепловым перепадам	ISO 10545_9		Conforme Compliant Konform Conforme Conforme Соответствует	Prova superata secondo la EN ISO 10545-1 - Test passed in accordance with EN ISO 10545-1 - Prüfung gemäß EN ISO 10545-1 bestanden - Essai réussi conformément à la norme EN ISO 10545-1 - Prueba superada de conformidad con la EN ISO 10545-1 - Испытание пройдено в соответствии со стандартом EN ISO 10545-1	UNI EN 14411-G
Coefficiente di dilatazione termica lineare Coefficient of linear thermal expansion Linearer Wärmeausdehnungs-Koeffizient Coefficient lineaire de dilatation thermique Coeficiente de dilatación térmica lineal Кэффициент линейного теплового расширения	ISO 10545_8	X10 <sup>-4</sup> /°C	< 9	Valore dichiarato Value declared Erklärter wert Valeur déclarée Valor declarado Заявленное значение	UNI EN 14411-G

CARATTERISTICA CHARACTERISTIC EIGENSCHAFTEN CARACTERISTIQUE CARACTERÍSTICA ХАРАКТЕРИСТИКА	METODO DI PROVA TESTING METHOD PRÜFMETHODE MÉTHODE D'ESSAI MÉTODO DE PRUEBA МЕТОД ИСПЫТАНИЯ	UNITA DI MISURA MEASUREMENT UNIT MAßEINHEIT UNITE DE MESURE UNIDAD DE MEDIDA ЕДИНИЦА ИЗМЕРЕНИЯ	VALORI TIPICI MEDI AVERAGE TYPICAL VALUES TYPISCHE DURCHSCHNITTSWERTE VALEURS MOYENNES TYPIQUES VALORES TÍPICOS MEDIOS СРЕДНИЕ ТИПОВЫЕ ЗНАЧЕНИЯ	VALORI LIMITE PREVISTI ESTABLISHED LIMITS VORGEGEHENE GRENZWERTE VALEURS LIMITES PREVUES VALORES LIMITE PREVISTOS ОЖИДАЕМЫЕ ПРЕДЕЛЬНЫЕ ЗНАЧЕНИЯ	NORMA DI RIFERIMENTO REFERENCE STANDARD BEZUGSNORM NORME DE REFERENCIAS NORMA DE REFERENCIA СТАНДАРТ ДЛЯ СРАВКИ
Resistenza alle macchie Resistance to staining Beständigkeit gegen Fleckenbildner Résistance aux produits tachants Resistencia a las manchas Стойкость к пятнообразованию	ISO 10545_14		classe 5 class 5 klasse 5 classe 5 categoria 5 класс 5	classe 3 minimo class 3 minimum Mind. klasse 3 classe 3 minimum categoria 3 minimo минимум класс 3	UNI EN 14411-G
Resistenza ai prodotti chimici di uso domestico e sali per piscina - Resistance to chemicals for household use and swimming pool salts - Beständigkeit gegen Haushaltschemikalien und Zusätze für Schwimmbäder - Résistance aux produits chimiques d'usage domestique et sels pour piscine - Resistencia a los productos químicos para uso doméstico y sales para piscina - Устойчивость к бытовым химическим средствам и солям для бассейнов	ISO 10545_13		A	B minimo B minimum Mind. B B minimum B minimo Минимальный UB	UNI EN 14411-G
Resistenza agli acidi e alle basi Resistance to acids and bases Säure- und Laugenfestigkeit Résistance aux acides et aux bases Resistencia a los ácidos y a las bases Стойкость к кислотам и щелочам			LA - LB HA - HB	Valore dichiarato Value declared Erklärter wert Valeur déclarée Valor declarado Заявленное значение	UNI EN 14411-G
Resistenza dei colori alla luce Colour resistance to light exposure Farblichkeit unter Lichteinfluss Résistance des couleurs à la lumière Resistencia de los colores a la exposición de la luz Светостойкость цветов	DIN 51094		Conforme Compliant Konform Conforme Conforme Соответствует	Non devono presentare apprezzabili alterazioni di colore - No sample must show noticeable colour modifications - Aucun échantillon ne doit présenter d'altérations appréciables de couleur - Kein Muster darf sichtbare Farbveränderungen aufweisen - Ninguna muestra ha de presentar alteraciones apreciables de color - Ни один из образцов не должен иметь значимых изменений цветов	
Resistenza allo scivolamento - Skid resistance - Rutschhemmung - Résistance au glissement Resistencia al deslizamiento - Сопротивление проскальзыванию	RAMP METHOD		R10	da R9 a R13 - from R9 to R13 - von R9 bis R13 - de R9 à R13 - de R9 a R13 - от R9 до R13	DIN 51130 DGUV REGEL 108-003*
Coefficiente di attrito medio Mean coefficient of friction Mittlerer Reibungskoeffizient Coefficient de frottement moyen Coeficiente de roce medio Средний коэффициент трения	B.C.R.		µ > 0,40	µ > 0,40	D.M. N°236 14/6/1989
Resistenza allo scivolamento - Skid resistance - Rutschhemmung - Résistance au glissement Resistencia al deslizamiento - Сопротивление проскальзыванию	PENDULUM		classe 1 - class 1 - klasse 1 - classe 1 - categoria 1 - класс 1		EN 12633 BOE N°74 del 2006
Resistenza allo scivolamento - Skid resistance - Rutschhemmung - Résistance au glissement Resistencia al deslizamiento - Сопротивление проскальзыванию	PENDULUM		PTV > 36 (slider 96)	0 - 24 Scivoloso - Slippery - Rutschig - Glissant - Resbaladizo - Скользящий 25 - 35 Scivolosità moderata - Moderately slippery - Mäßige Rutschgefahr - Glissance modérée - Deslizamiento moderado - Умеренная скользкость > 36 Basso rischio scivolamento - Low slipping risk - Geringe Rutschgefahr - Risque de glissement faible - Bajo riesgo de deslizamiento - Низкий риск скольжения	BSEN13036-4:2011
Resistenza allo scivolamento - Skid resistance - Rutschhemmung - Résistance au glissement Resistencia al deslizamiento - Сопротивление проскальзыванию	DIGITAL TRIBOMETER (ID-COF)		> 0,42	> 0,42	ANSI A326.3:2017

(a) Differenza ammissibile tra dimensione di fabbricazione e dimensione nominale - Permissible difference between work size and nominal size - Zulässige Differenz zwischen Werksmaß und Nenmmaß - Différence admissible entre la dimension de fabrication et la dimension nominale - Diferencia admisible entre medida de fabricación y medida nominal - Допустимая разница между фактическим размером изделия и номинальным.

(b) Deviazione ammissibile in % della dimensione media di una singola piastrella (2 o 4 lati) dalla dimensione di fabbricazione - Permissible % variation in the average size of a single tile (2 or 4 sides) from the work size - Zulässige Abweichung, in %, der mittleren Größe einer Einzelfliese (2 oder 4 Seiten) vom Werksmaß - Déviation admissible en % de la dimension moyenne d'un seul carreau (2 ou 4 côtés) par rapport à la dimension de fabrication - En porcentaje, desviación admisible del tamaño medio de un solo azulejo (2 o 4 lados) con respecto a la medida de fabricación - Допустимое отклонение в % среднего размера каждой плитки (2 или 4 стороны) от фактических размеров.

(c) c.c. Deviazione massima ammissibile della curvatura del centro, in % oppure mm, in rapporto alla diagonale calcolata secondo le dimensioni di fabbricazione | e.c. Deviazione massima ammissibile della curvatura dello spigolo, in % oppure mm, in rapporto alle dimensioni di fabbricazione corrispondenti | w. Deviazione massima ammissibile dello svergolamento, in % oppure mm, in rapporto alla diagonale calcolata secondo le dimensioni di fabbricazione - c.c. Maximum permissible deviation, in % or mm, in the centre curvature from the diagonal calculated on the basis of the work size | e.c. Maximum permissible deviation, in % or mm, from the diagonal calculated on the basis of the work size - c.c. Maximal zulässige Abweichung der Mittelpunktwölbung, in % oder mm, bezogen auf die über das Werksmaß berechnete Diagonale | w. Maximal zulässige Abweichung der Kantenvölbung, in % oder mm, bezogen auf das zugehörige Werksmaß | w. Maximal zulässige Abweichung der Windschiefe, in % oder mm, bezogen auf die über das Werksmaß berechnete Diagonale - c.c. Déviation maximale admissible de la courbure du centre, en % ou en mm, par rapport à la diagonale calculée selon les dimensions de fabrication | e.c. Déviation maximale admissible de la courbure de l'angle, en % ou en mm, par rapport aux dimensions de fabrication correspondantes | w. Déviation maximale admissible du voile en % ou en mm, par rapport à la diagonale calculée selon les dimensions de fabrication - c.c. En porcentaje o en milímetros, desviación máxima admisible de la curvatura del centro con respecto a la diagonal calculada según las medidas de fabricación | e.c. En porcentaje o en milímetros, desviación máxima admisible de la curvatura de la esquina con respecto a las medidas de fabricación correspondientes | w. En porcentaje o en milímetros, desviación máxima admisible del abarquillamiento con respecto a la diagonal calculada según las medidas de fabricación - c.c. Максимальное допустимое отклонение изгиба центра в % или в мм по отношению к диагонали, рассчитанное по фактическим размерам | e.c. Максимальное допустимое отклонение изгиба кромок в % или в мм по отношению к соответствующим фактическим размерам | w. Максимальное допустимое отклонение перекоса в % или в мм по отношению к диагонали, рассчитанное по фактическим размерам.

\* Pavimentazioni di ambienti lavorativi e zone operative con superfici sdrucciolevoli. - Flooring of work environments and operating areas with slippery surface. - Bodenbeläge für Arbeitsräume und Arbeitsbereiche mit Rutschgefahr. - Sols de locaux industriels et de zones de travail à surfaces dérapantes. - Pavimentaciones de zonas de trabajo y operativas con superficies resbaladizas. - Полы в рабочих помещениях и рабочих зонах со скользкими поверхностями.

\*\* Pavimentazioni per zone bagnate con calpestio a piedi scalzi. - Flooring for wet areas to be walked on barefoot. - Bodenbeläge in nassbelasteten Barfußbereichen. - Sols pour zones mouillées avec piétinement pieds nus. - Pavimentaciones para zonas mojadas donde se camina con pies descalzos. - Полы для влажных зон, предназначенные для хождения по ним босиком.

# Imballaggio INCANTO & MAIORA

packaging / verpackung / emballage / embalajes / упаковка

Per ordini di due o più articoli nello stesso formato - o anche in formati differenti purché modulari - si raccomanda di riporre le lastre in un'unica cassa, fino al suo riempimento. È opportuno spedire le casse in condizioni di massimo carico.

<b>Cassa per lastre 120x120</b>	<b>Cassa per lastre 120x240</b>	<b>Cassa per lastre 120x278</b>
<b>Cassa in legno</b> (Pz sfusi) dimensioni cm 139 x 139 x 38h - Mq lastra 1,44 - Kg lastra 22,95 - Lastre per cassa 24 - Mq per cassa 34,56 - Kg cassa piena 632	<b>Cassa in legno</b> (Pz sfusi) dimensioni cm 139 x 266 x 41h - Mq lastra 2,88 - Kg lastra 45,90 - Lastre per cassa 20 - Mq per cassa 57,60 - Kg cassa piena 1021	<b>Cassa in legno</b> (Pz sfusi) dimensioni cm 140 x 291 x 41h - Mq lastra 3,34 - Kg lastra 52,99 - Lastre per cassa 18 - Mq per cassa 60,05 - Kg cassa piena 1074

For orders for two or more articles in the same size - or in multiple modular sizes - slabs must be placed in the same crate, until full. Crates should be shipped filled to capacity.

<b>Crate for slabs of 120x120</b>	<b>Crate for slabs of 120x240</b>	<b>Crate for slabs of 120x278</b>
<b>Wooden crate</b> (Loose pcs) dimensions 139 x 139 x 38h - Slab area 1.44 m <sup>2</sup> - Slab weight 22.95 kg - Slabs per crate 24 - M <sup>2</sup> per crate 34.56 - Weight of full crate 632 kg	<b>Wooden crate</b> (Loose pcs) dimensions 139 x 266 x 41h - Slab area 2.88 m <sup>2</sup> - Slab weight 45.90 kg - Slabs per crate 20 - M <sup>2</sup> per crate 57.60 - Weight of full crate 1021 kg	<b>Wooden crate</b> (Loose pcs) dimensions 140 x 291 x 41h - Slab area 3.34 m <sup>2</sup> - Slab weight 52.99 kg - Slabs per crate 18 - M <sup>2</sup> per crate 60.05 - Weight of full crate 1074 kg

Für Bestellungen von einem oder mehreren Artikeln desselben Formats - oder auch mehrerer, jedoch modularer Formate - wird empfohlen, die Platten in einer einzigen Kiste zu verpacken, bis diese gefüllt ist. Es wird empfohlen, die Kisten vollbeladen zu versenden.

<b>Kiste für Platten 120x120</b>	<b>Kiste für Platten 120x240</b>	<b>Kiste für Platten 120x278</b>
<b>Holz-kiste</b> (Losgut) Abmessungen 139 x 139 x H38 cm - Plattenfläche 1,44 m <sup>2</sup> - Plattengewicht 22,95 kg - Platten pro Kiste 24 - Fläche pro Kiste 34,56 m <sup>2</sup> - Vollst. beladene Kiste 632 kg	<b>Holz-kiste</b> (Losgut) Abmessungen 139 x 266 x H41 cm - Plattenfläche 2,88 m <sup>2</sup> - Plattengewicht 45,90 kg - Platten pro Kiste 20 - Fläche pro Kiste 57,60 m <sup>2</sup> - Vollst. beladene Kiste 1021 kg	<b>Holz-kiste</b> (Losgut) Abmessungen 140 x 291 x H41 cm - Plattenfläche 3,34 m <sup>2</sup> - Plattengewicht 52,99 kg - Platten pro Kiste 18 - Fläche pro Kiste 60,05 m <sup>2</sup> - Vollst. beladene Kiste 1074 kg

Pour des commandes de deux ou plusieurs articles du même format (ou de formats différents, à condition d'être modulaires), il est recommandé de mettre les dalles dans une seule caisse jusqu'à que qu'elle soit pleine. Il convient d'expédier des caisses chargées au maximum.

<b>Caisse pour dalles de 120x120</b>	<b>Caisse pour dalles de 120x240</b>	<b>Caisse pour dalles de 120x278</b>
<b>Caisse en bois</b> (Pièces en vrac) dimensions 139 cm x 139 cm x h38 cm - Dalle 1,44 m <sup>2</sup> - Dalle 22,95 kg - Dalles par caisse 24 - m <sup>2</sup> par caisse 34,56 - Caisse pleine 632 kg	<b>Caisse en bois</b> (Pièces en vrac) dimensions 139 cm x 266 cm x h41 cm - Dalle 2,88 m <sup>2</sup> - Dalle 45,90 kg - Dalles par caisse 20 - m <sup>2</sup> par caisse 57,60 - Caisse pleine 1021 kg	<b>Caisse en bois</b> (Pièces en vrac) dimensions 140 cm x 291 cm x h41 cm - Dalle 3,34 m <sup>2</sup> - Dalle 52,99 kg - Dalles par caisse 18 - m <sup>2</sup> par caisse 60,05 - Caisse pleine 1074 kg

En el caso de pedidos de dos o más artículos del mismo formato - o también de formatos diferentes, pero modulares - se recomienda embalar las placas en una única caja, hasta llenarla por completo. Resulta oportuno transportar las cajas en condiciones de carga máxima.

<b>Caja para placas de 120 x 120 cm</b>	<b>Caja para placas de 120 x 240 cm</b>	<b>Caja para placas de 120 x 278 cm</b>
<b>Caja de madera</b> (Piezas sueltas) medidas de 139 x 139 x 38 h cm - placa 1,44 m <sup>2</sup> - placa 22,95 kg - 24 placas en cada caja grande - 34,56 m <sup>2</sup> por caja grande - Caja grande llena 632 kg	<b>Caja de madera</b> (Piezas sueltas) medidas de 139 x 266 x 41 h cm - placa 2,88 m <sup>2</sup> - placa 45,90 kg - 20 placas en cada caja grande - 57,60 m <sup>2</sup> por caja grande - Caja grande llena 1021 kg	<b>Caja de madera</b> (Piezas sueltas) medidas de 140 x 291 x 41 h cm - placa 3,34 m <sup>2</sup> - placa 52,99 kg - 18 placas en cada caja grande - 60,05 m <sup>2</sup> por caja grande - Caja grande llena 1074 kg

При заказе двух или более артикулов одного формата, а также разных, но кратных форматов, рекомендуется упаковывать плиты в один ящик, вплоть до его заполнения. Рекомендуется отправлять максимально заполненные ящики.

<b>Ящик для плит 120 x 120</b>	<b>Ящик для плит 120 x 240</b>	<b>Ящик для плит 120 x 278</b>
<b>Деревянный ящик</b> (Изделия россыпью) размеры 139 x 139 x В. 38 см - Площадь плиты: 1,44 кв.м. - Вес плиты: 22,95 кг - Плит в ящике: 24 шт. - Кв.м. в ящике: 34,56 - Вес полного ящика: 632 кг	<b>Деревянный ящик</b> (Изделия россыпью) размеры 139 x 266 x В. 41 см - Площадь плиты: 2,88 кв.м. - Вес плиты: 45,90 кг - Плит в ящике: 20 шт. - Кв.м. в ящике: 57,60 - Вес полного ящика: 1021 кг	<b>Деревянный ящик</b> (Изделия россыпью) размеры 140 x 291 x В. 41 см - Площадь плиты: 3,34 кв.м. - Вес плиты: 52,99 кг - Плит в ящике: 18 шт. - Кв.м. в ящике: 60,05 - Вес полного ящика: 1074 кг

L'utilizzo dei cavalletti avviene solo su richiesta del cliente. Per ordini di due o più articoli nello stesso formato - o anche in formati differenti purché modulari - si raccomanda di riporre le lastre in un unico cavalletto, fino al suo riempimento. È opportuno spedire i cavalletti in condizioni di massimo carico.

<b>Cavalletto</b> (Pz sfusi) - 120x240 dimensioni cm 75 x 250 x 160h - Mq lastra 2,88 - Kg lastra 46,08 - Lastre per cavalletto 48 - Mq per cavalletto 134,24 - Kg cavalletto pieno 2375	<b>Cavalletto</b> (Pz sfusi) - 120x278 dimensioni cm 75 x 290 x 160h - Mq lastra 3,34 - Kg lastra 52,99 - Lastre per cavalletto 36 - Mq per cavalletto 120,10 - Kg cavalletto pieno 2088
--	--

A-frames are only used when requested by the customer. For orders for two or more articles in the same size - or in multiple modular sizes - slabs must be placed in the same A-frame, until full. A-frames should be shipped filled to capacity.

<b>A-Frame</b> (Loose pcs) - 120x240 dimensions 75 x 250 x 160h cm - Slab area 2.88 m <sup>2</sup> - Slab weight 46,08 kg - Slabs per A-frame 48 - M <sup>2</sup> per A-frame 134,24 - Weight of full A-frame 2375 kg	<b>A-Frame</b> (Loose pcs) - 120x278 dimensions 75 x 290 x 160h cm - Slab area 3.34 m <sup>2</sup> - Slab weight 52,99 kg - Slabs per A-frame 36 - M <sup>2</sup> per A-frame 120,10 - Weight of full A-frame 2088 kg
---	---

Die Verpackung in Transportgestellen erfolgt nur auf Anfrage des Kunden. Für Bestellungen von einem oder mehreren Artikeln desselben Formats - oder auch mehrerer, jedoch modularer Formate - wird empfohlen, die Platten in einem einzigen Transportgestell zu verpacken, bis dieses gefüllt ist. Es wird empfohlen, die Transportgestelle vollbeladen zu versenden.

<b>Transportgestell</b> (Losgut) - 120x240 Abmessungen 75 x 250 x H160 cm - Plattenfläche 2,88 m <sup>2</sup> - Plattengewicht 46,08 kg - Platten pro Transportgestell 48 - Fläche pro Transportgestell 134,24 m <sup>2</sup> - Vollst. beladenes Transportgestell 2375 kg	<b>Transportgestell</b> (Losgut) - 120x278 Abmessungen 75 x 290 x H160 cm - Plattenfläche 3,34 m <sup>2</sup> - Plattengewicht 52,99 kg - Platten pro Transportgestell 36 - Fläche pro Transportgestell 120,10 m <sup>2</sup> - Vollst. beladenes Transportgestell 2088 kg
--	--

L'utilisation des chevalets de transport n'est effectuée qu'à la demande du client. Pour des commandes de deux ou plusieurs articles du même format (ou de formats différents, à condition d'être modulaires), il est recommandé de mettre les dalles sur un seul chevalet jusqu'à que qu'il soit plein. Il convient d'expédier des chevalets chargés au maximum.

<b>Chevalet de transport</b> (Pièces en vrac) 120x240 dimensions 75 cm x 250 cm x h160 cm - Dalle 2,88 m <sup>2</sup> - Dalle 46,08 kg - Dalles par chevalet de transport 48 - m <sup>2</sup> par chevalet de transport 134,24 - Chevalet de transport plein 2375 kg	<b>Chevalet de transport</b> (Pièces en vrac) 120x278 dimensions 75 cm x 290 cm x h160 cm - Dalle 3,34 m <sup>2</sup> - Dalle 52,99 kg - Dalles par chevalet de transport 36 - m <sup>2</sup> par chevalet de transport 120,10 - Chevalet de transport plein 2088 kg
--	--

Se usarán caballetes solamente si así lo solicita el cliente. En el caso de pedidos de dos o más artículos del mismo formato - o también de formatos diferentes, pero modulares - se recomienda embalar las placas en un único caballete, hasta llenarlo por completo. Resulta oportuno transportar los caballetes en condiciones de carga máxima.

<b>Caballete</b> (Piezas sueltas) - 120x240 medidas 75 x 250 x 160 h cm - placa 2,88 m <sup>2</sup> - placa 46,08 kg - 48 placas por caballete - 134,24 m <sup>2</sup> por caballete - Caballete lleno 2375 kg	<b>Caballete</b> (Piezas sueltas) - 120x278 medidas 75 x 290 x 160 h cm - placa 3,34 m <sup>2</sup> - placa 52,99 kg - 36 placas por caballete - 120,10 m <sup>2</sup> por caballete - Caballete lleno 2088 kg
--	--

Упаковка на подставках осуществляется лишь только по заказу клиента. При заказе двух или более артикулов одного формата, а также разных, но кратных форматов, рекомендуется размещать плиты на одной подставке, вплоть до ее заполнения. Рекомендуется отправлять максимально заполненные подставки.

<b>Подставка</b> (Изделия россыпью) - 120x240 размеры 75 x 250 x В. 160 см - Площадь плиты: 2,88 кв.м. - Вес плиты: 46,08 кг - Плит на подставке: 48 шт. - Кв.м. на подставке: 134,24 - Вес полной подставки: 2375 кг.	<b>Подставка</b> (Изделия россыпью) - 120x278 размеры 75 x 290 x В. 160 см - Площадь плиты: 3,34 кв.м. - Вес плиты: 52,99 кг - Плит на подставке: 36 шт. - Кв.м. на подставке: 120,10 - Вес полной подставки: 2088 кг.
--	--

## Consigli di posa e manutenzione

advice for laying and maintenance / verlegungs / und Pflegehinweise / conseils pour la pose et l'entretien  
consejos de colocación y mantenimiento / рекомендации по укладке и уходу EN

### POSA IN OPERA

Prima di iniziare le operazioni di posa di una qualsiasi superficie si raccomanda di accertarsi che la partita di materiale sia adeguata e sufficiente per quantità, tono e calibro, a quella necessaria. Si dovranno poi seguire tutte le norme e le precauzioni che sono alla base di una corretta esecuzione del lavoro (preparazione del sottofondo, composizione della malta o dei collanti, rispetto dei tempi di essicazione, posizionamento dei giunti di dilatazione, battitura, ecc...).

### POSA CON ADESIVI

- La posa deve essere effettuata da personale qualificato con l'ausilio di attrezzi adeguati.
- La superficie su cui si effettua la posa [massetto] deve essere perfettamente piana. Valore massimo consigliato non superiore a 3 mm. per un dislivello determinato sotto un regolo di 2 m.
- La superficie su cui si effettua la posa deve essere ben stagionata, priva di polvere e di fessurazioni visibili.
- Durante l'operazione di posa è vivamente consigliato l'utilizzo di un'adeguata illuminazione.
- La scelta dell'adesivo è condizionata dalla tipologia delle piastrelle (gruppo di appartenenza e formato), dal tipo di superficie da rivestire e dalla sua destinazione d'uso.
- È opportuno verificare la posa del materiale prima che il collante sia secco, per facilitare eventuali correzioni.

### POSA CON MALTA FRESCA

La posa a malta cementizia fresca o "strato spesso" è sconsigliata per formati aventi lato > 30 cm e con supporti non assorbenti.

### REALIZZAZIONE DEI GIUNTI

I giunti sono elementi molto importanti per il mantenimento di una buona superficie piastrellata e si consiglia di avvalersi della collaborazione e/o consulenza di un posatore professionista. Si declina ogni responsabilità per la posa senza fuga; si considera posa a "giunto minimo" quella con fuga a 2 mm.

I giunti devono essere posizionati:

- su raccordi strutturali (giunti strutturali)
- tra suolo e parete (giunti perimetrali)
- tra una piastrella e l'altra (giunti di posa o fuga)
- tra piastrelle ed altri materiali (es. accostamento ceramica / linoleum / legno).

### STUCCATURA SUPERFICIE POSATA

Prima di realizzare le fughe è consigliabile attendere fino a completa asciugatura del collante e assicurarsi che i giunti di posa siano vuoti e liberi da ogni traccia di collante e/o polveri.

- Stuccare piccole superfici per volta (4-5 mq). Questo è da tenere in particolare considerazione per prodotti strutturati, antiscivolo e levigati.
- Eliminare l'eccesso di fugante dalla superficie con movimenti diagonali quando il prodotto è ancora umido e togliere tutti i residui, in particolar modo per le superfici da esterno.
- Pulire accuratamente con una spugna bagnata in acqua limpida e pulita e ripassare con straccio umido su tutta la superficie, fughe comprese.
- Per fughe in netto contrasto cromatico con le piastrelle posate è consigliabile testare il fugante su un' area circoscritta e nascosta.
- Per gli stucchi epossidici si raccomanda la pulizia con spugna e abbondante acqua. La velocità di reazione e indurimento di questi prodotti rende impossibile la rimozione dei residui successivamente all'indurimento. Il giorno dopo la stuccatura effettuare una pulizia completa con detergente alcalino.
- Si consiglia di consultare i produttori di materiale fugante per verificare la scelta corretta della fuga rispetto al tipo di piastrella.

### PULIZIA E MANUTENZIONE DOPO LA POSA

Un cantiere si può considerare completamente finito quando è sgombro da qualunque utensile/materiale derivante dalle lavorazioni. Per ridurre i rischi di danneggiamento della superficie piastrellata, è necessario proteggerla ed evitare il più possibile la presenza di materiali abrasivi (polveri o residui da lavorazioni successive).

### PULIZIA INIZIALE

Il lavaggio dopo la posa è una fase di fondamentale importanza per tutti gli interventi successivi e per una corretta manutenzione.

Un accurato lavaggio iniziale permette ai pavimenti di restare belli e protetti a lungo e si esegue normalmente una sola volta prima dell'utilizzo del pavimento. Si raccomanda di effettuare la pulizia iniziale dopo 4-5 giorni e non più tardi di 10, dalla posa e stuccatura della superficie.

La superficie fugata e pulita può presentare un film di residui cementizi che non sono asportabili con sola acqua per cui si rende necessario l'utilizzo di un prodotto a base acida, opportunamente diluito (diluizione da 1:10 a 1:4 in acqua fredda), in base a quanto dichiarato dal produttore.

La prima operazione da eseguire è quella di bagnare la superficie piastrellata ed in particolare le fughe (di norma non resistenti agli acidi). Spargere la soluzione acida preparata e lasciare agire per un breve tempo (2 min). Non lasciare asciugare il prodotto applicato.

Procedere alla rimozione della soluzione aiutandosi con una macchina monospazzola (disco non abrasivo), aspiraliquidi, altri mezzi e/o manualmente e alla fine risciacquare abbondantemente.

È importante sottolineare che la pulizia eseguita con macchine (particolarmente consigliata per prodotti strutturati e per grandi superfici), va sempre completata manualmente nei punti difficilmente raggiungibili, soprattutto negli angoli, lungo le pareti dei locali e in ogni zona in cui la monospazzola non può operare.

È sempre consigliabile testare la resistenza del prodotto agli acidi su un pezzo non posato o su una piccola porzione nascosta della superficie piastrellata; in particolare per prodotti lappati o levigati. L'uso di prodotti di pulizia contenenti acido fluoridrico (HF) e suoi derivati sono da evitare.

### PULIZIA ORDINARIA

Gli interventi di pulizia ordinaria delle superfici hanno lo scopo di rimuovere lo sporco, cancellare i segni e ripristinare l'aspetto originale.

Le piastrelle in gres porcellanato smaltato non necessitano di trattamenti di protezione e una corretta e sistematica pulizia è sufficiente a mantenere inalterata la superficie.

Un'accurata pulizia deve essere fatta con un normale lavaggio con acqua calda, straccio/ spugna morbida ed eventualmente con l'utilizzo di detergenti neutri. Per locali con grandi superfici possono essere utilizzate macchine industriali lavasciuga con completamento manuale dove necessario.

Raccomandazioni:

- evitare di strofinare le superfici con strumenti abrasivi, come pagliette in metallo o spazzole dure, che potrebbero lasciare graffi e segni indelebili;
- rimuovere eventuali residui grassi o oleosi con detergenti contenenti solventi organici o con detergenti alcalini (pH-9) e fare seguire un accurato risciacquo;
- evitare l'utilizzo di saponi in quanto tendono a lasciare uno strato viscido, in particolare se utilizzati in abbinamento ad acque dure;
- non utilizzare prodotti contenenti cere o brillantanti;
- evitare l'uso di detergenti abrasivi su superfici lucide e/o levigate; possono essere utilizzati su materiali matt., previa verifica su una piccola porzione piastrellata. In generale l'uso di qualunque detergente non neutro, deve essere preliminarmente testato su una piastrella non posata o su una porzione nascosta della pavimentazione.

### CONSIGLI DI POSA A PAVIMENTO PER FORMATI RETTANGOLARI

Per i formati rettangolari, oltre alla posa ortogonale, si consiglia la posa a correre, regolare o irregolare, con una differenza tra pezzo e pezzo di:

- max 1/4 per formati: 15x90 - 10x120 - 15x120 - 20x120 - 30x120 - 60x120 - 58x116 - 29x116 -19,5x116 - 14,4x116
- max 1/3 per formati: 14,5x58 - 15x60 - 30x60 - 37,5x75 - 29x58 - 20x40

Per approfondimenti consultare il sito [www.ragno.it](http://www.ragno.it)

### LAYING

Before laying on any surface, make sure that the material is appropriate and sufficient in terms of quantity, shade and work-size to suit the laying needs. All regulations and precautions concerning the correct execution of the works must be followed (preparing the bed, grout or adhesive composition, respect for drying times, position of the expansion joints, beating, etc...).

### LAYING WITH ADHESIVES

- Laying must be done by qualified staff using appropriate equipment.
- The surface to be laid (screed) must be perfectly level. Maximum recommended value no more than 3 mm for an uneven surface measured with a 2 m ruler.
- The surface to be laid must be well seasoned, dust-free and with no visible cracks.
- During laying the use of appropriate lighting is strongly recommended.
- The choice of adhesive depends on the type of tile (type and size), the type of surface laid on and the type of foreseen use.
- Check that the tiles are laid correctly before the adhesive dries in order to facilitate any required corrections.

### LAYING WITH FRESH MORTAR

Laying with fresh cement-based mortar or "thick layers" is not recommended for sizes more than 30 cm long and with non-absorbent supports.

### JOINTS

Joints are very important elements for maintaining a good tiled surface, it is recommended to make use of the collaboration and/or advice of a professional layer.

The company declines all responsibility for laying without joints; minimum joint laying has a gap of 2 mm.

The joints must be positioned:

- on structural joints;
- between the floor and the wall (perimeter joints);
- between one tile and another (laying joints);
- between the tiles and other materials (e.g. combinations of ceramics/linoleum /wood).

### GROUTING LAID SURFACES

Before grouting wait for the adhesive to dry completely and make sure that the laying joints are empty and free of all traces of adhesive and/or dust.

- Grout small areas at a time (4-5 m2). This is particularly important for structured products, non-slip and polished surfaces.
- Remove excess grout from the tiles using diagonal movements when the product is still damp and remove all residues, particularly for external surfaces.
- Clean carefully using a sponge dampened in clean, limpid water and go over the whole surface, including the gaps, with a damp cloth.
- For grouting which has a strong colour contrast to the laid tiles, test the grout on a small, hidden area.
- When using epoxy grouts, clean with a sponge and plenty of water. The reaction and hardening times of these products make it impossible to remove any residues once they have hardened. The day after grouting, completely clean the surface with an alkaline detergent.
- Consult the grout manufacturers to verify the correct choice of grout for the type of tile.

### CLEANING AND MAINTENANCE AFTER LAYING

Worksites are deemed to be completely finished once they have been cleared of all tools and materials used during the operations. To reduce the risk of damaging tiled surfaces, protect them and avoid the presence of abrasive materials (dust and residues from operations carried out after laying) as far as possible.

### INITIAL CLEANING

Washing after laying is of fundamental importance to all operations carried out afterwards and to assure correct maintenance.

Careful initial cleaning keeps floors beautiful and protected longer and is done once only before using the floor.

Initial cleaning should be carried out 4-5 days after laying, and in any case no longer than 10 days after laying and grouting.

The grouted and cleaned surface may have a concrete film which cannot be removed using water alone, and therefore an acid-based product, suitably diluted (from 1:10 to 1:4 in cold water) should be used, following the manufacturer's instructions.

The first operation is to wet the tiled surface and particularly the gaps (grout is not usually acid-resistant). Spread the prepared acid solution and leave for a short time (2 minutes). Do not allow the applied product to dry.

Remove the solution using a brushing machine (with a non-abrasive disk), wet vac or other means and/or manually, then rinse well.

It should be remembered that machine cleaning (which is particularly recommended for textured products and large surfaces) must always be completed by hand in tight corners, along walls and any spaces that the brushing machine cannot easily reach.

It is always advisable to test the resistance of the product to acids on an unlaid tile or a small hidden surface; particularly for lapped or polished products.

It is not recommended to use cleaning products containing hydrofluoric acid (HF) or its derivatives.

### ORDINARY CLEANING

Ordinary cleaning removes dirt and marks and restores the surface to its original appearance.

Porcelain stoneware tiles do not require protective treatment, and a thorough, systematic clean is sufficient to maintain the surface.

Careful cleaning must be done by washing normally using hot water, a cloth or soft sponge and, if required, neutral detergents.

For large areas, industrial washing machines can be used, with completion by hand where required.

Recommendations:

- Do not rub the surfaces using abrasive tools, such as metallic sponges or hard brushes, which could scratch them or leave indelible marks;
- Grease and oil residues can be removed using detergents using organic or alkaline solvents (pH-9) followed by careful rinsing;
- Avoid the use of soap as this tends to leave a slimy layer, particularly when used with hard water;
- Do not use products containing wax or shining agents;
- Avoid the use of abrasive detergents on shiny and/or polished surfaces; they may be used on matt materials, checking first on a small hidden tiled area. Generally speaking, when using any non-neutral detergent, check first on an unlaid tile or a small hidden portion of the floor.

### RECOMMENDATIONS FOR LAYING RECTANGULAR TILES AS A FLOOR COVERING

Apart from laying aligned in both directions, rectangular sizes should be laid in regular or irregular rows, or staggered rows with a distance between joints of:

- max 1/4 of a tile for sizes: 15x90 - 10x120 - 15x120 - 20x120 - 30x120 - 60x120 - 58x116 - 29x116 - 19,5x116 - 14,4x116
- max 1/3 of a tile for sizes: 14,5x58 - 15x60 - 30x60 - 37,5x75 - 29x58 - 20x40

For further details, visit [www.ragno.it](http://www.ragno.it)

## Consigli di posa e manutenzione

advice for laying and maintenance / verlegungs / und Pflegehinweise / conseils pour la pose et l'entretien  
consejos de colocación y mantenimiento / рекомендации по укладке и уходу EN

### BAUSEITIGE VERLEGUNG

Stellen Sie, bevor Sie mit der Verlegung der Fliesen beginnen, sicher, dass die Materialpartie im Hinblick auf Menge, Farbton und Größenklasse die Anforderungen erfüllt und ausreicht. Es müssen außerdem alle Normen und Vorsichtsmaßnahmen eingehalten werden, die die Grundlage für eine korrekte Ausführung der Arbeiten darstellen (Vorbereitung des Untergrunds, Zusammensetzung des Mörtels oder der Kleber, Trocknungszeiten, Lage der Dehnungsfugen, Anklöpfen usw....).

### VERLEGUNG MIT KLEBER

- Die Verlegung muss durch qualifiziertes Personal mit geeigneten Werkzeugen durchgeführt werden.
- Die Fläche, auf der die Verlegung erfolgt (Estrich) muss perfekt eben sein. Empfohlener maximaler Wert der Abweichung nicht über 3 mm beim Anlegen eines 2 m-langen Richtscheits.
- Die Fläche, auf der die Verlegung erfolgen soll, muss vollständig trocken und frei von Staub und sichtbaren Rissen sein.
- Während der Verlegung wird dringend empfohlen, eine ausreichende Beleuchtung zu gewährleisten.
- Die Wahl des Klebers hängt von der Art der Fliesen (Gruppe und Größe), von der Art der Oberfläche, auf der verlegt werden soll und vom Bestimmungszweck ab.
- Die Verlegung der Fliesen sollte überprüft werden, bevor der Kleber trocken ist, um Korrekturen zu ermöglichen.

### VERLEGUNG MIT FRISCHEM MÖRTEL

Die Verlegung mit frischem Zementmörtel oder „Dickbettverlegung“ wird für Formate empfohlen, deren Seitenmaße größer als 30 cm sind und die auf nicht absorbierenden Untergründen verlegt werden sollen.

### DIE VERFUGUNG

Die Fugen sind für den Erhalt einer guten Fliesenoberfläche sehr wichtig und wir empfehlen, dafür die Arbeit bzw. Beratung eines Fachmanns in Anspruch zu nehmen. Wir übernehmen keine Haftung für eine fugenlose Verlegung, unter einer Verlegung mit sehr schmalen Fugen versteht man die Verlegung von 2 mm breiten Fugen.

Die Fugen müssen positioniert werden:

- an strukturellen Anschlüssen (Strukturfugen)
- zwischen Boden und Wand (Randfugen)
- zwischen einer Fliese und der anderen (Verlegefugen oder Fugen)
- zwischen Fliesen und anderen Materialien (z.B. Kombination von Keramik/ Linoleum/Holz).

### VERFUGEN VERLEGTER OBERFLÄCHEN

Bevor die Fugen ausgeführt werden, wird empfohlen, zu warten, bis der Kleber komplett trocken ist. Stellen Sie sicher, dass die Verlegefugen leer und frei von jeglichen Spuren von Klebstoff und/oder Staub sind.

- Verfügen Sie jeweils kleine Flächen (4 - 5 m<sup>2</sup>). Dies gilt vor allem für strukturierte, rutschfeste und polierte Fliesen.
- Entfernen Sie die überschüssige Fugenmasse mit diagonalen Bewegungen von der Oberfläche aus, wenn das Produkt noch feucht ist und entfernen Sie, vor allem in Außenbereichen, alle Rückstände.
- Gründlich mit einem Schwamm, der in reinem und klarem Wasser befeuchtet wurde, reinigen und mit einem feuchten Tuch über die gesamte Fläche einschließlich der Fugen nachwischen.
- Für Fugen, die im eindeutigen Farbkontrast zu den verlegten Fliesen stehen, sollten Sie die Fugenmasse an einer begrenzten, verdeckten Fläche vorher testen.
- Für Epoxyd-Fugenmörtel wird die Reinigung mit einem Schwamm und sauberem Wasser empfohlen. Die schnelle Reaktion und das schnelle Härten dieser Produkte macht die Beseitigung von Rückständen nach dem Aushärten unmöglich. Am Tag nach der Verlegung ist eine gründliche Reinigung mit alkalischen Reinigungsmitteln erforderlich.
- Für die jeweilige Wahl der Fuge für die jeweilige Fliese wenden Sie sich bitte an den Hersteller des Fugenmittels.

### REINIGUNG UND PFLEGE NACH DER VERLEGUNG

Eine Baustelle ist erst vollständig beendet, wenn sie frei von jedem Arbeitsmaterial ist. Um die Gefahr der Beschädigung der Fliesenoberfläche zu senken, ist es notwendig, sie zu schützen und so weit wie möglich die Anwesenheit von abrasiven Materialien (Pulver oder Rückstände der weiteren Verarbeitung) zu vermeiden.

### GRUNDREINIGUNG

Die Grundreinigung nach der Verlegung ist wichtig, um die spätere Reinigung und Pflege zu ermöglichen.

Eine sorgfältige Grundreinigung sorgt dafür, dass die Böden lange schön und geschützt bleiben. Sie wird normalerweise nur einmal vor der Benutzung des Bodens ausgeführt.

Es wird empfohlen, die Erstreinigung nach 4-5 Tagen, spätestens aber nach 10 Tagen ab dem Verlegen und Verfugen der Oberfläche durchzuführen. Die verfugte und gereinigte Oberfläche kann einen Zementschleier aufweisen, der aber leicht nur mit Wasser entfernt werden kann. Dafür ist ein Reinigungsmittel auf Säurebasis erforderlich, das je nach den Anweisungen des Herstellers entsprechend verdünnt (Verdünnung von 1:10 bis 1:4 mit kaltem Wasser). Zuerst muss die geflieste Fläche mit Wasser gespült werden, dies gilt vor allem für die Fugen (die normalerweise nicht säurebeständig sind). Verteilen Sie die vorbereitete säurehaltige Lösung auf der Oberfläche und lassen Sie diese kurz einwirken (2 Minuten). Lassen Sie das aufgebrachte Mittel nicht eintrocknen. Entfernen Sie dann die Lösung mit einer Einbürstemaschine (nichtscheuernde Scheibe), einem Flüssigkeitssauger oder einem anderen Gerät, und/oder spülen Sie mit reichlich klarem Wasser nach. Es muss darauf hingewiesen werden, dass die maschinelle Reinigung einer Oberfläche (die besonders für strukturierte und große Oberflächen empfohlen wird) an den schwierig zu erreichenden Stellen stets eine manuelle Nachreinigung erforderlich macht, vor allem in den Ecken, entlang der Wände und in allen Bereichen, die von der Einbürstemaschine nicht erreicht werden. Es ist immer ratsam, die Haltbarkeit des Produktes gegen Säuren auf einer noch nicht verlegten Fliese oder in einem versteckten Bereich der bereits verfliesen Oberfläche zu testen, dies gilt insbesondere für geläppte oder polierte Fliesen. Die Verwendung von Reinigungsmitteln mit Flusssäure (HF) und seinen Derivate ist zu vermeiden.

### GEWÖHNLICHE REINIGUNG UND PFLEGE

Die gewöhnliche Reinigung der Oberflächen dient der Entfernung von Schmutz, Spuren und Abdrücken. Sie hat das Ziel, das ursprüngliche Aussehen wieder herzustellen.

Glasierte Feinsteinzeugfliesen benötigen keine Schutzbehandlung und die korrekte und systematische Reinigung ist ausreichend, um die Oberfläche dauerhaft schön zu halten.

Eine gründliche Reinigung sollte mit warmem Wasser, einem Lappen oder weichen Schwamm und eventuell mit neutralen Reinigungsmitteln erfolgen. Für Räume mit großen Flächen können industrielle Reinigungsmaschinen verwendet werden, ggf. mit manueller Nachreinigung.

Empfehlungen:

- vermeiden Sie es, die Oberflächen mit Schleifmitteln, wie Scheuerschwämmen oder harten Bürsten zu reinigen, das kann zu Kratzern und Spuren führen, die sich nicht mehr entfernen lassen;
- entfernen Sie eventuell verbleibende Fett- oder Ölrückstände mit Reinigungsmitteln, die organische Lösemittel enthalten, oder alkalischen Reinigungsmitteln (pH> 9) und spülen Sie dann gründlich nach;
- Vermeiden Sie Seifen, da sie dazu neigen, eine schmierige Schicht zu hinterlassen, besonders wenn sie in Verbindung mit hartem Wasser verwendet werden;
- Verwenden Sie keine Produkte mit Wachs oder Glanzzusätzen;
- Vermeiden Sie Scheuermittel auf polierten oder glänzenden Oberflächen. Sie können auf jedoch matten Materialien verwendet werden, nachdem ein Test auf einem kleinen bereits verlegten Bereich erfolgt ist. Im Allgemeinen muss jedes nicht neutrale Reinigungsmittel zuerst auf einer nicht verlegten Fliese oder in einem verdeckten bereits verlegten Bereich getestet werden.

### HINWEISE ZUR VERLEGUNG VON RECHTECKFORMATEN ALS BODENBELAG

Für die Rechteckformate wird, neben der rechtwinkligen Verlegung, die fortlaufende Verlegung im regelmäßigen oder unregelmäßigen Verband mit dem folgenden Versatz empfohlen:

- Kantenverhältnis max. 4:1 für die Formate: 15x90 - 10x120 - 15x120 - 20x120 - 30x120 - 60x120 - 58x116 - 29x116 - 19,5x116 - 14,4x116
- Kantenverhältnis max. 3:1 für die Formate: 14,5x58 - 15x60 - 30x60 - 37,5x75 - 29x58 - 20x40

Ausführliche Informationen finden Sie auf [www.ragno.it](http://www.ragno.it)

### POSE

Avant de commencer les opérations de pose d'une surface quelle qu'elle soit, il est recommandé de veiller à ce que le matériau soit adapté et de quantité suffisante, que le ton et le calibre correspondent aux besoins. Il faudra ensuite se conformer à toutes les normes et prendre toutes les précautions qui sont à la base d'une bonne exécution du travail (préparation de la sous-couche, composition du mortier ou des colles, temps de séchage, mise en place des joints de dilatation, battage, etc....).

### POSE AVEC DES ADHÉSIFS

- La pose doit être effectuée par un personnel qualifié qui se servira d'outils appropriés.
- La surface sur laquelle la pose est effectuée (chape) doit être parfaitement plane. Valeur maximum conseillée : max 3 mm pour une dénivellation au-dessous d'une règle de 2 m.
- La surface sur laquelle le matériau est posé doit être à parfaite maturation, sans poussière ni fissurations visibles.
- Au cours de la pose, un bon éclairage est vivement conseillé.
- L'adhésif sera choisi en fonction de la typologie des carreaux (catégorie et format), du type de surface à revêtir et du domaine d'application auquel les carreaux sont destinés.
- Il convient de vérifier la manière dont le matériau est posé avant que l'adhésif ne soit sec, afin de pouvoir effectuer plus facilement des corrections si besoin est.

### POSE AVEC MORTIER FRAIS

La pose avec du mortier à base de ciment frais ou par "couche épaisse" est déconseillée pour des formats ayant un côté >30 cm et avec des supports non absorbants.

### RÉALISATION DES JOINTS

Les joints sont des éléments très importants pour qu'une surface carrelée se maintienne bien. C'est une phase pour laquelle il est conseillé de demander la collaboration et/ou les conseils d'un carreleur professionnel.

La responsabilité du fabricant ne pourra pas être mise en cause en cas de pose sans jointoiements. On appelle "pose à joint minimum" une pose avec un joint de 2 mm.

Les joints doivent être positionnés :

- sur des raccords structurels [joints structurels]
- entre sol et mur [joints périmétraux]
- entre deux carreaux [joints de pose ou jointoiement]
- entre des carreaux et d'autres matériaux (ex. juxtaposition céramique/lino/bois).

### JOINTOIEMENT DES SURFACES POSÉES

Avant de procéder au jointoiement, il est conseillé d'attendre que l'adhésif soit bien sec et de s'assurer que les joints de pose sont vides et libres de toute trace d'adhésif et/ou de poussières.

- Jointoyer le carrelage en procédant par petites surfaces (4-5 m<sup>2</sup>). Ce conseil doit surtout être suivi pour des produits structurés, antidérapants et polis.
- Éliminer le surplus de coulis de remplissage des joints de la surface en effectuant des mouvements en diagonale quand le produit est encore humide et enlever toutes les traces excédentaires, surtout pour les surfaces posées à l'extérieur.
- Nettoyer soigneusement avec une éponge imbibée d'eau claire et propre et repasser avec un chiffon humide sur toute la surface, joints compris.
- En présence de joints nettement contrastants avec la couleur des carreaux posés, il est conseillé de tester le coulis de remplissage des joints sur une petite surface dissimulée.
- Pour les joints époxy, il est recommandé de nettoyer à grande eau avec une éponge. La vitesse de réaction et de durcissement de ces produits empêche l'élimination des excédents après qu'ils ont durci. Le lendemain du jointoiement, effectuer un nettoyage complet avec un nettoyant alcalin.
- Il est conseillé de consulter les fabricants de coulis de remplissage des joints pour vérifier si le choix effectué est correct par rapport au type de carreau.

### NETTOYAGE ET ENTRETIEN APRÈS LA POSE

Un chantier peut être considéré comme entièrement fini quand il est débarrassé de tous les outils et de tout le matériel ayant servi à sa réalisation. Pour réduire les risques d'endommager la surface carrelée, il est nécessaire de la protéger et d'éviter le plus possible la présence de matières abrasives (poussières ou résidus laissés par les travaux effectués successivement).

### NETTOYAGE INITIAL

Le lavage après la pose est une opération d'une extrême importance pour toutes les opérations qui s'ensuivront et pour pouvoir effectuer un entretien correct au quotidien.

Bien nettoyer le carrelage au départ permet aux sols de garder longtemps leur beauté et d'être protégés à long terme. Généralement, ce nettoyage est effectué une seule fois avant d'utiliser le sol.

Il est recommandé d'effectuer le nettoyage initial entre 4 et 5 jours (pas plus de 10) après la pose et le jointoiement.

La surface jointoyée et nettoyée peut présenter un film d'excédents cimentaires qui ne peut pas être éliminé à l'eau. Il est donc nécessaire d'utiliser un produit à base acide, correctement dilué (dilution de 1:10 à 1:4 dans l'eau froide), en fonction des conseils d'utilisation donnés par le fabricant.

La première opération à exécuter est de mouiller la surface carrelée et en particulier les joints (qui généralement ne résistent pas aux acides). Répandre la solution acide préparée et laisser agir environ 2 minutes. Ne pas laisser sécher le produit appliqué.

Procéder à l'élimination de la solution avec une laveuse monobrosse (disque non abrasif), aspirateurs de liquides, autres appareils et/ou à la main. Rincer à grande eau à la fin.

Soulignons que le nettoyage effectué avec des appareils (particulièrement conseillé pour des produits structurés et pour de grandes surfaces), doit toujours être parachevé par une intervention manuelle aux endroits difficiles à atteindre, c'est-à-dire dans les coins, le long des murs et partout où la monobrosse ne peut pas arriver.

Il est toujours conseillé de vérifier la résistance du produit aux acides en les testant sur un carreau non posé ou sur un endroit peu en vue d'un carreau de la surface déjà posée, surtout pour les produits rodés ou polis. L'utilisation de nettoyeurs contenant de l'acide fluorhydrique (HF) et de ses dérivés doit être évitée.

### ENTRETIEN COURANT

Les opérations d'entretien courant des surfaces ont pour but d'éliminer la saleté, d'effacer les traces et de rendre au carrelage son aspect premier.

Les carreaux en grès cérame émaillé n'ont pas besoin d'être traités pour être protégés. Un nettoyage correct et systématique suffit à préserver la beauté de leur surface. Un nettoyage soigné doit être fait par un lavage normal avec de l'eau chaude, une serpillière/éponge douce et éventuellement avec un nettoyant neutre. Pour les locaux recouverts de grandes surfaces, une machine industrielle lavante-séchante peut être utilisée. Finir par un lavage à la main là où cela s'avère nécessaire.

Recommandations :

- éviter de frotter les surfaces avec des instruments abrasifs tels que les pailles de fer ou les brosses dures, qui pourraient laisser des rayures et des traces indélébiles ;
- éliminer toute trace de graisse ou d'huile éventuellement présente au moyen de nettoyeurs contenant des solvants organiques, ou avec des nettoyeurs alcalins (pH>9) et terminer en rinçant soigneusement ;
- éviter d'utiliser des savons car ils ont tendance à laisser un film visqueux, surtout s'ils sont utilisés avec des eaux dures ;
- ne pas utiliser de produits contenant des cires ou des brillanturs ;
- éviter d'utiliser des nettoyeurs décapants sur des surfaces lustrées et/ou polies ; ils peuvent être utilisés sur des matériaux mats, après les avoir testés sur un petit coin carrelé. En général, l'utilisation de tout nettoyant non neutre doit être testée au préalable sur un carreau non posé ou sur une portion peu en vue du sol.

### CONSEILS DE POSE SUR SOLS POUR LES FORMATS RECTANGULAIRES

Pour les formats rectangulaires, outre une pose orthogonale, il est conseillé de procéder à une pose à l'anglaise régulière ou irrégulière, avec un décalage entre les pièces de :

- max 1/4 pour les formats : 15x90 - 10x120 - 15x120 - 20x120 - 30x120 - 60x120 - 58x116 - 29x116 - 19,5x116 - 14,4x116
- max 1/3 pour les formats : 14,5x58 - 15x60 - 30x60 - 37,5x75 - 29x58 - 20x40

Pour plus de renseignements, veuillez consulter le site [www.ragno.it](http://www.ragno.it)

## Consigli di posa e manutenzione

advice for laying and maintenance / verlegungs / und Pflegehinweise / conseils pour la pose et l’entretien  
consejos de colocación y mantenimiento / recomendaciones по укладке и уходу EN

### COLOCACIÓN

Antes de iniciar las operaciones de colocación de cualquier superficie, se recomienda asegurarse de que la cantidad del lote de material sea suficiente y de que el tono y el calibre sean adecuados. Deberán seguirse luego todas las normas y precauciones para una correcta ejecución del trabajo (preparación de la base, composición del mortero o de los adhesivos, respeto de los tiempos de secado, posición de las juntas de dilatación, golpeado, etc...).

### COLOCACIÓN CON ADHESIVOS

- La colocación ha de ser efectuada por personal cualificado con la ayuda de herramientas adecuadas.
- La superficie sobre la que se efectúe la colocación (placa) ha de ser totalmente plana. Valor máximo aconsejado no superior a 3 mm para un desnivel determinado bajo una regla de 2 m.
- La superficie sobre la que se efectúe la colocación deberá estar bien seca, sin polvo ni fisuraciones visibles.
- Es importante utilizar una iluminación adecuada durante la operación de colocación.
- La elección del adhesivo dependerá del tipo de baldosa (grupo de pertenencia y formato), del tipo de superficie a recubrir y del uso previsto.
- Conviene comprobar la colocación del material antes de que el adhesivo esté seco, con el fin de facilitar posibles correcciones.

### COLOCACIÓN CON MORTERO FRESCO

La colocación con mortero de cemento fresco o “capa gruesa” está aconsejada para formatos con lado > 30 cm y con soportes no absorbentes.

### REALIZACIÓN DE LAS JUNTAS

Las juntas son elementos muy importantes para el mantenimiento de una buena superficie embaldosada; se aconseja servirse de la colaboración y/o del asesoramiento de un solador profesional. Se declina toda responsabilidad por la colocación sin juntas; se considera colocación de “junta mínima” la efectuada con una junta de 2 mm.

Las juntas deberán estar posicionadas:

- en uniones estructurales (juntas estructurales)
- entre el suelo y la pared (juntas perimetrales)
- entre una baldosa y otra (juntas de colocación o juntas)
- entre baldosas y otros materiales (por ej. combinación de cerámica / linóleo / madera)

### REJUNTADO DE LA SUPERFICIE EMBALDOSADA

- Antes de realizar las juntas, es aconsejable esperar a que el adhesivo esté completamente seco y asegurarse de que las juntas de colocación estén vacías y libres de todo rastro de adhesivo y/o polvo.
- Efectuar el rejuntado de pequeñas superficies cada vez (4-5 m2). Ello deberá tenerse en cuenta sobre todo para productos estructurados, antideslizantes y pulidos.
  - Eliminar de la superficie el material de rejuntado en exceso efectuando movimientos diagonales cuando el producto todavía está húmedo y quitar todos los residuos, especialmente para las superficies de exterior.
  - Limpiar cuidadosamente con una esponja mojada en agua limpia y repasar con un paño húmedo por toda la superficie, incluidas las juntas.
  - Para juntas cuyo color contraste fuertemente con el de las baldosas colocadas, se aconseja probar el material de rejuntado en una zona limitada y escondida.
  - Para los rellenos de juntas epoxi, se recomienda limpiar con una esponja y agua abundante. La velocidad de reacción y endurecimiento de estos productos impide poder quitar los residuos después del endurecimiento. Efectuar una limpieza completa con detergente alcalino al día siguiente de haber realizado el rejuntado.
  - Se aconseja consultar a los fabricantes del material de rejuntado para comprobar si elección de la junta es correcta para el tipo de baldosa.

### LIMPIEZA Y MANTENIMIENTO DESPUÉS DE LA COLOCACIÓN

Una obra puede considerarse completamente acabada cuando está libre de todas las herramientas y de todos los materiales derivados de los trabajos llevados a cabo. Para impedir que se dañe la superficie embaldosada, es necesario protegerla y evitar lo más posible la presencia de materiales abrasivos (polvo o residuos de trabajos sucesivos).

### LIMPIEZA INICIAL

La limpieza después de la colocación es una fase de fundamental importancia para todas las intervenciones sucesivas y para un correcto mantenimiento. Una cuidadosa limpieza inicial permitirá que los pavimentos permanezcan bonitos y protegidos durante largo tiempo; suele efectuarse una sola vez antes de la utilización del pavimento. Se recomienda efectuar la limpieza inicial después de 4-5 días, y no más tarde de 10, de la colocación y del rejuntado de la superficie. La superficie con las juntas y limpia puede presentar una película de residuo de cemento que no es posible quitar sólo con agua, siendo necesaria la utilización de un producto de base ácida, oportunamente diluido (dilución de 1:10 a 1:4 en agua fría), según lo declarado por el fabricante. La primera operación a efectuar es mojar la superficie embaldosada y en particular las juntas (normalmente no resistentes a los ácidos). Esparcir la solución ácida preparada y dejar actuar durante breve tiempo (2 min.). No dejar secar el producto aplicado. Remover la solución con la ayuda de una máquina monocepillo (con disco no abrasivo), un aspirador de líquidos, otros medios y/o de forma manual y aclarar con agua abundante al final. Es importante subrayar que la limpieza efectuada con máquinas (especialmente aconsejada para productos estructurados y para grandes superficies) ha de completarse siempre de forma manual en aquellos puntos difíciles de alcanzar, sobre todo en los rincones, en las paredes de los locales y en todas aquellas zonas en las que la máquina monocepillo no puede operar. Es aconsejable siempre probar la resistencia del producto a los ácidos en una baldosa sin colocar o sobre una pequeña porción escondida de la superficie embaldosada, sobre todo para productos lapeados o pulidos. Evitar el uso de productos de limpieza que contengan ácido fluorhídrico (HF) y sus derivados.

### LIMPIEZA ORDINARIA

Las operaciones de limpieza ordinaria de las superficies tienen la finalidad de eliminar la suciedad, borrar las señales y restablecer el aspecto original. Las baldosas de gres porcelánico esmaltado no necesitan tratamientos de protección; una correcta y sistemática limpieza es suficiente para mantener inalterada la superficie. Para una cuidadosa limpieza deberá efectuarse un fregado normal con agua caliente, paño/esponja suave y, si es necesario, con la utilización de detergentes neutros. En los locales con grandes superficies podrán utilizarse máquinas industriales fregadoras-secadoras, completando la limpieza de manera manual donde sea necesario. Recomendaciones:

- no restregar las superficies con instrumentos abrasivos, como estropajos de metal o cepillos duros, que pudieran dejar arañazos y señales indelebles;
- quitar los posibles residuos oleosos o de grasas con detergentes que contengan disolventes orgánicos o con detergentes alcalinos (pH>9) y efectuar un cuidadoso aclarado;
- evitar la utilización de jabones, pues tienden a dejar una capa viscosa, sobre todo si se utilizan con aguas duras;
- no utilizar productos que contengan ceras o agentes de brillantado;
- evitar el uso de detergentes abrasivos sobre superficies brillantes y/o pulidas; pueden utilizarse sobre materiales mates, pero controlando previamente sobre una pequeña porción embaldosada. El uso de cualquier detergente no neutro deberá ser probado previamente sobre una baldosa sin colocar o sobre una porción escondida del pavimento.

### CONSEJOS PARA LA PAVIMENTACIÓN CON FORMATOS RECTANGULARES

En lo que concierne a los formatos rectangulares, además de la colocación ortogonal, se aconseja el solado corrido regular o irregular con un escalonamiento recomendado entre pieza y pieza de:

- como máximo 1/4 en los formatos de: 15x90 - 10x120 - 15x120 - 20x120 - 30x120 - 60x120 - 58x116 - 29x116 - 19,5x116 - 14,4x116
- como máximo 1/3 en los formatos de: 14,5x58 - 15x60 - 30x60 - 37,5x75 - 29x58 - 20x40

Para mayor información, consulte el sitio web [www.ragno.it](http://www.ragno.it)

### UKLADKA

Antes de comenzar los trabajos de colocación de cualquier superficie, se recomienda asegurarse de que la cantidad del lote de material sea suficiente y de que el tono y el calibre sean adecuados. Deberán seguirse luego todas las normas y precauciones para una correcta ejecución del trabajo (preparación de la base, composición del mortero o de los adhesivos, respeto de los tiempos de secado, posición de las juntas de dilatación, golpeado, etc...).

### UKLADKA S PRIMENIENIEM KLEJASHCHIX SOSTAVOV

- Ukladka dolzhna proizvoditsya kvalifitsirovannym personalom s pomoshchyu sootvetstvuyushchix instrumentov.
- Poverkhnost', na kotoruyu proizvoditsya ukladka (tsementnaya stjazhka), dolzhna byt' absolutno rovnoy. Maksimalno dopustimyy perepad urovnya ne dolzhen prevyshat' 3 mm pri izmerenii lineykoj dlinnoy 2 m.
- Poverkhnost', na kotoruyu proizvoditsya ukladka, dolzhna byt' dobrosho vyderzhannoy, oichishchenoj ot pyli i bez vidimyykh treshchin.
- Vo vremya vypolneniya ukladki nastoyatelno rekomenduем ispol'zovat' sootvetstvuyushchee osvesheniye.
- Vybor kleyashchego sostava zavysit ot tipa plitki (gruppa priнадлежности и формата), типа покрываемой поверхности и ее назначения.
- Dlya ustraneniya vozmozhnykh defektov sleduet proveryat' ukladku materiala, prezhde chem kleyashchiy sostav vysохнет.

### UKLADKA S PRIMENIENIEM SVJEZHEGO TSEMENTNOGO RASTVORA

La colocación con mortero de cemento fresco o “capa gruesa” está aconsejada para formatos con lado > 30 cm y con soportes no absorbentes.

### ВЫПОЛНЕНИЕ ШВОВ

Швы являются важнейшим элементом для поддержания поверхности, облицованной плиткой, в хорошем состоянии, именно поэтому мы рекомендуем привлекать к сотрудничеству и/или консультации профессионального укладчика. Отклоняется любая ответственность в случае укладки без швов; минимальным швом считается зазор 2 мм. Швы должны присутствовать:

- на конструктивных соединениях (конструктивные швы)
- между полом и стеной (периметральные швы)
- между плитками (укладочные швы)
- между плитками и другими материалами (например, сочленение керамики/линолеума/дерева).

### ЗАТИРКА ШВОВ НА УЛОЖЕННОЙ ПОВЕРХНОСТИ

- Antes de comenzar los trabajos de colocación de cualquier superficie, se recomienda asegurarse de que la cantidad del lote de material sea suficiente y de que el tono y el calibre sean adecuados. Deberán seguirse luego todas las normas y precauciones para una correcta ejecución del trabajo (preparación de la base, composición del mortero o de los adhesivos, respeto de los tiempos de secado, posición de las juntas de dilatación, golpeado, etc...).
- Перед началом затирки швов рекомендуется выждать до полного высыхания клея и убедиться в том, что укладочные швы чистые и не содержат остатков клея и/или пыли.
- Швы следует заделывать по частям небольшими поверхностями (4-5 кв.м). Это особенно важно учитывать при укладке структурной, нескользящей и полированной плитки.
  - Удалите с поверхности избыток затирочного материала диагональными движениями, пока затирка влажная, и уберите все излишки, особенно с наружных поверхностей.
  - Аккуратно промойте губкой, смоченной в чистой прозрачной воде, и протрите всю поверхность, включая швы, влажной тряпкой.
  - Для швов, контрастных по цвету с уложенной плиткой, рекомендуется протестировать затирку на ограниченном скрытом участке поверхности.
  - Для оксидных затирок рекомендуется очистка с помощью обильно смоченной водой губки. Скорость реакции и затверждение этих продуктов делает невозможным их удаление после затвердения. На следующий день после затирки швов следует выполнить полную уборку с применением щелочного моющего средства.
  - Рекомендуется проконсультироваться у производителей затирочного материала, чтобы убедиться в правильном его выборе относительно типа плитки.

### УБОРКА И УХОД ПОСЛЕ УКЛАДКИ

Строительство можно считать законченным, когда его площадка полностью расчищена от любого материала/инструментария, использованных во время работ. Для снижения рисков повреждения поверхности, покрытой плиткой, необходимо предохранять ее и не допускать присутствия каких-либо абразивных материалов (пыль или остатки затирочных материалов).

### НАЧАЛЬНАЯ УБОРКА

Промывание после укладки имеет исключительно важное значение для всех последующих действий и для правильного ухода за поверхностью. Тщательная начальная промывка обеспечивает полам хороший внешний вид и длительную защищенность, обычно она выполняется однократно перед началом эксплуатации полов. Начальную промывку рекомендуется выполнять по истечении 4-5 дней и не позднее 10 дней после затирки швов. На очищенной поверхности с заделанными швами может появиться пленка из цементного осадка, которая не удаляется только водой; в этом случае необходимо применение моющего средства с кислотной основой, правильно разведенного в воде (разбавление в холодной воде в пропорции от 1:10 до 1:4) в соответствии с указаниями производителя. Первое, что необходимо выполнить, это смочить водой покрытую плиткой поверхность и, особенно, швы (как правило, нестойкие к воздействию кислот). Затем нанесите приготовленный кислотный раствор и оставьте действовать на короткое время (2 мин.). Не допускайте высыхания нанесенного продукта. Далее приступайте к удалению раствора с помощью пологоочной машины (с неабразивным диском), водным пылесосом, другими средствами и/или вручную и в конце следует обильное промывание. Важно подчеркнуть, что очистка, выполненная с помощью машин (особенно рекомендуемая для структурной продукции и больших поверхностей), должна обязательно завершаться ручной уборкой труднодоступных мест, особенно, в углах, вдоль стен внутри помещения и во всех местах, куда щетка не может добраться). Рекомендуется всегда протестировать устойчивость материала к воздействию кислот на неужоженной плитке или на маленьком скрытом участке, покрытом плиткой; это особенно важно для полуполированной и полированной плитки. Следует избегать применения моющих средств, содержащих плавиковую кислоту (HF) и ее производные.

### РЕГУЛЯРНАЯ УБОРКА

Регулярная уборка поверхности производится для удаления грязи, следов и для восстановления изначального внешнего вида. Плитка из глазурованного керамогранита не нуждается в защитной обработке, для поддержания поверхности в неизменном виде достаточно правильно и систематически производить ее уборку. Тщательная уборка должна производиться путем обычного промывания теплой водой, тряпкой/мягкой губкой, при необходимости, с применением нейтральных моющих средств. Для помещений с большими поверхностями можно использовать промышленные пологоочные машины, дополняя, где необходимо, ручной промывкой. Рекомендации:

- не допускать натирания поверхностей абразивными материалами, как например, губки из металлической стружки или жесткие щетки, которые могут оставить царапины и несмываемые следы;
- удалить возможные жирные или масляные пятна с помощью моющих средств, содержащих органические растворители, или с помощью щелочных моющих средств (pH>9), после чего тщательно прополоскать.
- не применять мыло, так как после него образуется липкая пленка, особенно если используется жесткая вода;
- не применять продукты, содержащие воск или придающие блеск вещества;
- не применять абразивные моющие средства на блестящих и/или полированных поверхностях; они могут использоваться на матовых материалах, однако, предварительно их следует протестировать на маленьком участке плиточной поверхности. В целом, использование любого не нейтрального моющего средства, должно быть предварительно опробовано на неужоженной плитке или на скрытом участке пола.

### РЕКОМЕНДАЦИИ ПО НАПОЛЬНОЙ УКЛАДКЕ ПРЯМОУГОЛЬНЫХ ФОРМАТОВ

Помимо ортогональной укладки, для прямоугольных форматов рекомендуется укладка с равномерным или неравномерным разгоном между двумя соседними элементами, равным:

- макс. 1/4 для форматов: 15x90 - 10x120 - 15x120 - 20x120 - 30x120 - 60x120 - 58x116 - 29x116 - 19,5x116 - 14,4x116
- макс. 1/3 для форматов: 14,5x58 - 15x60 - 30x60 - 37,5x75 - 29x58 - 20x40

Более подробную информацию см. на сайте [www.ragno.it](http://www.ragno.it)

# Norme di trattamento

treatment procedures / behandlungshinweise / normes de traitement / normas de tratamiento / правила промывки

GRES FINE PORCELLANATO: TIPO NATURALE; TIPO LEVIGATO FINE PORCELAIN STONWARE: MATT TYPE; POLISHED TYPE FEINSTEINZEUG: MATTE FLIESE; POLIERTE FLIESE	GRES CERAME FIN: TYPE BRUT; TYPE POLI GRES FINO PORCELÁNICO: TIPO MATE; TIPO PULIDO КЕРАМОГРАНИТ: НАТУРАЛЬНЫЙ; ПОЛИРОВАННЫЙ	
LAVORI DA ESEGUIRE JOBS TO BE PERFORMED AUSZUFÜRENDE ARBEITEN TRAVAUX A EXECUTER TRABAJOS A EFECTUAR ВЫПОЛНЯЕМЫЕ РАБОТЫ	MACCHINE MACHINES GERÄTE MACHINES MÁQUINAS МАШИНЫ	
LAVAGGIO CLEANING REINIGUNG NETTOYAGE LAVADO МОЙКА	Lavaggio di fondo e risciacquo - Tipo naturale Thorough washing and rinsing - Matt type Gründliche Reinigung und Abspülen - Matte Fliese Nettoyage à fond et rinçage - Type brut Fregado a fondo y enjuague - Tipo mate Тщательная мойка и протирка - Натуральный тип	Monospazzola / Aspiraliquidi Single-brush machine / Wet vacuum Einbürstenmaschine / Nasssauger Mono-brosse / Aspirateur à eau Máquina fregadora / Aspiradora de líquidos Однощеточная машина со сбором жидкостей
TRATTAMENTO TREATMENT BEHANDLUNG TRAITEMENT TRATAMIENTO ОБРАБОТКА	Impregnazione - Tipo levigato Impregnation - Polished type Imprägnierung - Polierte Fliese Imprégnation - Type poli Impregnación - Tipo pulido Пропитка - Полированный тип	
MANUTENZIONE MAINTENANCE PFLEGE ENTRETIEN MANTENIMIENTO УХОД	Pulizia ordinaria - Tipo naturale e levigato Routine cleaning - Matt and polished type Normale Reinigung - Matte und polierte Fliese Nettoyage ordinaire - Type brut et poli Limpieza ordinaria - Tipo mate y pulido Обычный уход - Натуральный и полированный тип	Lava-asciuga Scrubber-dryer Bodenreinigungs-maschine Laveuse-sécheuse Fregadora-secadora Машина для мойки и сушки пола
	Pulizia straordinaria - Tipo naturale Special cleaning - Matt type Sonderreinigung - Matte Fliese Nettoyage extraordinaire - Type brut Limpieza extraordinaria - Tipo mate Экстренный уход - Натуральный тип	Monospazzola / Aspiraliquidi Single-brush machine / Wet vacuum Einbürstenmaschine / Nasssauger Mono-brosse / Aspirateur à eau Máquina fregadora / Aspiradora de líquidos Однощеточная машина со сбором жидкостей
	Smacchiatura - Tipo levigato Stain removal - Polished type Fleckenentfernung - Polierte Fliese Elimination des taches - Type poli Eliminación manchas - Tipo pulido Выведение пятен - Полированный тип	

GRES FINE PORCELLANATO: TIPO NATURALE; TIPO LEVIGATO FINE PORCELAIN STONWARE: MATT TYPE; POLISHED TYPE FEINSTEINZEUG: MATTE FLIESE; POLIERTE FLIESE	GRES CERAME FIN: TYPE BRUT; TYPE POLI GRES FINO PORCELÁNICO: TIPO MATE; TIPO PULIDO КЕРАМОГРАНИТ: НАТУРАЛЬНЫЙ; ПОЛИРОВАННЫЙ	
ATTREZZI EQUIPMENT WERKZEUGE OUTILIS ÚTILES ОСНАСТКА	PRODOTTO * PRODUCT* PRODUKT* PRODUIT* PRODUCTO* ПРОДУКТ*	NOTE NOTES BEMERKUNGEN NOTES NOTAS ПРИМЕЧАНИЯ
Disco morbido Soft disk Weiche Scheibe Disque doux Disco blando Мягкий диск	Disincrostante acido Acid-based scale remover Säurehaltiger Entkalker Détartrant acide Desincrustante ácido Кислотный растворитель отложений	Diluire come da indicazioni sull'etichetta, stendere la soluzione. Lavare, aspirare. Risciacquare, aspirare. Dilute as per instructions on the label. Spread the solution. Wash, vacuum. Rinse, vacuum. Gemäß den Angaben auf dem Aufkleber verdünnen, die Lösung auftragen. Waschen, absaugen. Abspülen, absaugen. Diluer selon les indications sur l'étiquette, étaler la solution. Laver, aspirer. Rincer, aspirer. Diluir siguiendo las indicaciones de la etiqueta. Aplicar la solución. Fregar, aspirar. Enjuagar, aspirar. Разбавить согласно указаниям на этикетке, нанести раствор на поверхность. Промыть, собрать. Ополоснуть, собрать.
Pennellessa Flat brush Flachpinsel Brocha plana Большая кисть	Impermeabilizzante Waterproofing product Abdichtendes Mittel Imperméabilisant Герметик	Rimuovere il residuo secco dopo 24 ore con monospazzola o disco morbido. Remove the dry residue after 24 hours with a single-brush machine and soft disk. Das überschüssige, getrocknete Produkt nach 24 Stunden mit einem Einbürstengerät mit weicher Scheibe entfernen. Enlever le résidu sec au bout de 24 heures avec une machine mono-brosse et disque doux. Remover el residuo seco transcurridas 24 horas con máquina fregadora y disco blando. Удалить сухой остаток через 24 часа при помощи однощеточной машины с мягким диском.
Scopa - Straccio Broom - Rag Besen - Tuch Balai - Serpillière Escoba - Trapo/fregona Щетка - тряпка	Detergente per pavimenti ceramici Detergent for ceramic floors Reinigungsmittel für keramische Böden Détergent pour sols céramiques Detergente para pavimentos cerámicos Моющее средство для керамических полов	Per la pulizia di tutti i giorni; per rimuovere lo sporco di passaggio For daily cleaning; for removing dirt from traffic. Pour le nettoyage de tous les jours; pour éliminer la saleté due au passage. Für die tägliche Reinigung; um den durch Begehung entstandenen Schmutz zu entfernen. Para la limpieza diaria; para eliminar la suciedad provocada por el paso. Для ежедневной уборки; для удаления грязи от хождения.
Straccio Rag Tuch Serpillière Trapo/fregona Тряпка	Lavapavimenti forte Strong floor detergent Starkes Bodenreinigungs-mittel Détergent puissant pour sols Fregasuelos fuerte Сильнодействующее средство для мытья полов	Diluire come da indicazioni sull'etichetta Dilute as per instructions on the label Gemäß den Angaben auf dem Aufkleber verdünnen Diluer selon les indications sur l'étiquette Diluir siguiendo las indicaciones de la etiqueta Растворить согласно указаниям на этикетке
	Detergente smacchiatore Detergent-stain remover Reiniger/Fleckenentferner Détergent détachant Detergente quitamanchas Пятновыводящее моющее средство	Versare il prodotto puro sulla macchia e sull'intera mattonella, lasciare asciugare, risciacquare. Apply the product on the stain and the entire affected tile, without diluting, leave to dry, rinse. Das unverdünnte Produkt auf den Fleck und die gesamte Fliese auftragen, trocknen lassen, abspülen. Verser le produit pur sur la tache et sur tout le carreau. Laisser sécher, rincer. Verter el producto puro sobre la mancha y sobre todo el azulejo, dejar secar, enjuagar. Налить на пятно и на всю поверхность плитки чистый раствор, высушить, промыть.

\* Produttori consigliati / Producers recommended / Empfohlene Hersteller / Fabricants recommandés / Fabricantes aconsejados / Рекомендуемые производители:

BONASYSTEMS ITALIA S.r.l. info@bonasystemsitalia.it www.bonasystemsitalia.it  
 FILA S.p.A. fila@filachim.it www.filachim.com  
 FABER CHIMICA s.r.l. info@faberchimica.com www.faberchimica.com  
 GEAL-CHIM s.r.l. info@geal-chim.it www.geal-chim.it







L'Azienda si riserva la facoltà di modificare in qualunque momento le informazioni e le caratteristiche tecniche illustrate nel presente catalogo, che non sono comunque da ritenersi legalmente vincolanti. Pesi, colori e misure possono subire variazioni tipiche del particolare processo di cottura del materiale ceramico. I colori e le caratteristiche estetiche dei prodotti sono quanto più possibile vicini a quelli reali, nei limiti consentiti dai processi di stampa.

The Company reserves the right, at any time and without prior notice, to change the information and technical characteristics given in this catalogue, none of which are to be considered legally binding. Weights, colours and dimensions are subject to the normal variations resulting from the ceramic firing process. Within the limits of printed material, the colours and aesthetic features of the products illustrated correspond as closely as possible to those of the actual products.

Die Firma behält sich das Recht vor, die in diesem Katalog enthaltenen, unverbindlichen Angaben und technischen Eigenschaften jederzeit zu verändern. Gewichte, Farben und Abmessungen können infolge des besonderen Brennverfahrens des Keramikmaterials variieren. Die Abbildungen der Farben und die ästhetischen Merkmale entsprechen nach Möglichkeit und innerhalb der durch die Drucktechnik gesetzten Grenzen den Produkten.

L'entreprise se réserve le droit de modifier à tout moment les informations et les caractéristiques figurant dans ce catalogue lesquelles ne sauraient en tout état de cause engager juridiquement l'entreprise. Les poids, les coloris et les dimensions peuvent subir des variations, dues au processus de cuisson particulier du matériau céramique. Les coloris et les caractéristiques esthétiques des produits sont présentés de la façon la plus réaliste possible, dans les limites permises par les processus d'impression.

La empresa se reserva el derecho de modificar en cualquier momento las informaciones y las características técnicas ilustradas en el presente catálogo que no se deben considerar, de todos modos, jurídicamente vinculantes. Los valores del peso, los colores y las medidas pueden sufrir variaciones típicas del particular proceso de cocción del material cerámico. Los colores y las características estéticas de los productos ilustrados se parecen en la manera de lo posible a los originales, considerando las limitaciones del proceso de impresión.

Компания оставляет за собой право изменить в любой момент приведенные в данном каталоге сведения и технические характеристики, которые не должны считаться лояльно обязательными. Вес, цвета и размеры могут претерпеть изменения, свойственные особенно процессу обжига керамических материалов. Цвета и эстетические характеристики продукции максимально приближены к реальности, в степени, допустимой возможностями печати.

© Copyright by Ragno – Marazzi Group S.r.l. 2021. All Rights Reserved

06.2021



Ragno - Marazzi Group S.r.l a socio unico Viale Regina Pacis 39 41049 Sassuolo (MO), Italia  
telephone +39 0536.860.800 fax +39 0536.860.644 website: www.ragno.it e-mail: info@ragno.it

**RAGNO.IT**